



**OTS Volume 1: Genesis-Esther**  
**Singapore Bible College**  
**Rick Griffith, ThM, PhD**

**Old Testament Survey**



# Old Testament Survey (OT 501)

## Volume 1: Genesis-Esther

Singapore Bible College

Rick Griffith, ThM, PhD

Twenty-first Edition

© July 2014

1st-41st printings (1720 copies; 1<sup>st</sup>-17<sup>th</sup> eds. July 92- July 10)  
 42nd printing (50 copies; 18<sup>th</sup> ed. July 11)  
 43rd printing (10 copies; Mar 12)  
 44th printing (50 copies; 19<sup>th</sup> ed. July 12)  
 45th printing (10 copies; 20<sup>th</sup> ed. July 13)  
 46th printing (20 copies; 21<sup>st</sup> ed. July 14)

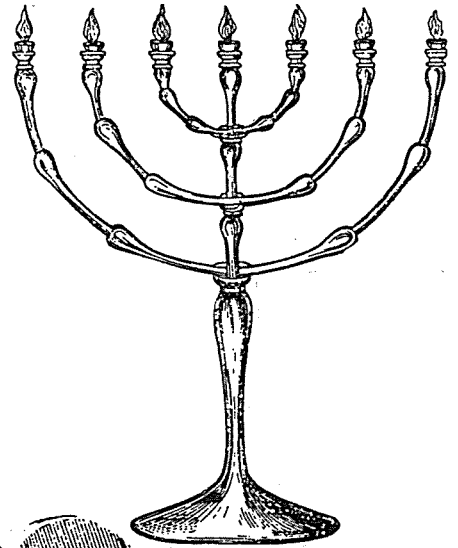

אכל אישכים אנחנו יל-אחינו  
 ate guilty we [are] brother our of account on  
 צרת נפשו ברהרנו ראו אשר  
 treated he when soul whose of distress the saw we  
 וְיָאָה אֶתְּיָנוּ יוֹלָא וְיָאָה  
 came has therefore hear did two but and  
 וְיָאָה רְאוּבֵן וְיָאָה הַמִּזְרָחָה  
 Reuben answered And this the-  
 אֶתְּיָנוּ וְיָאָה הַמִּזְרָחָה  
 you unto speak of did And saying  
 אֶתְּיָנוּ וְיָאָה הַמִּזְרָחָה  
 our did you but and youth the against  
 וְיָאָה הַמִּזְרָחָה וְיָאָה הַמִּזְרָחָה  
 they And respired is behold blood his  
 וְיָאָה הַמִּזְרָחָה וְיָאָה הַמִּזְרָחָה  
 respired the because Joseph shearing [was] that know  
 וְיָאָה הַמִּזְרָחָה וְיָאָה הַמִּזְרָחָה  
 us [and] them [they] from away turned he And them between [was]  
 וְיָאָה הַמִּזְרָחָה וְיָאָה הַמִּזְרָחָה  
 took he and them into spoke and them unto returned and  
 וְיָאָה הַמִּזְרָחָה וְיָאָה הַמִּזְרָחָה  
 him [and] [and] Simon them [with] from  
 וְיָאָה הַמִּזְרָחָה וְיָאָה הַמִּזְרָחָה  
 filled they and Joseph commandment gave And eyes their before  
 וְיָאָה הַמִּזְרָחָה וְיָאָה הַמִּזְרָחָה  
 [and] money their return to and gain [with] vessels their  
 וְיָאָה הַמִּזְרָחָה וְיָאָה הַמִּזְרָחָה  
 way the for provision them to give to and sack his into  
 וְיָאָה הַמִּזְרָחָה וְיָאָה הַמִּזְרָחָה  
 grain their basted they And for them to did our and  
 וְיָאָה הַמִּזְרָחָה וְיָאָה הַמִּזְרָחָה  
 one opened And thence went and asses their to  
 וְיָאָה הַמִּזְרָחָה וְיָאָה הַמִּזְרָחָה  
 bulging the in ase his to folder give to

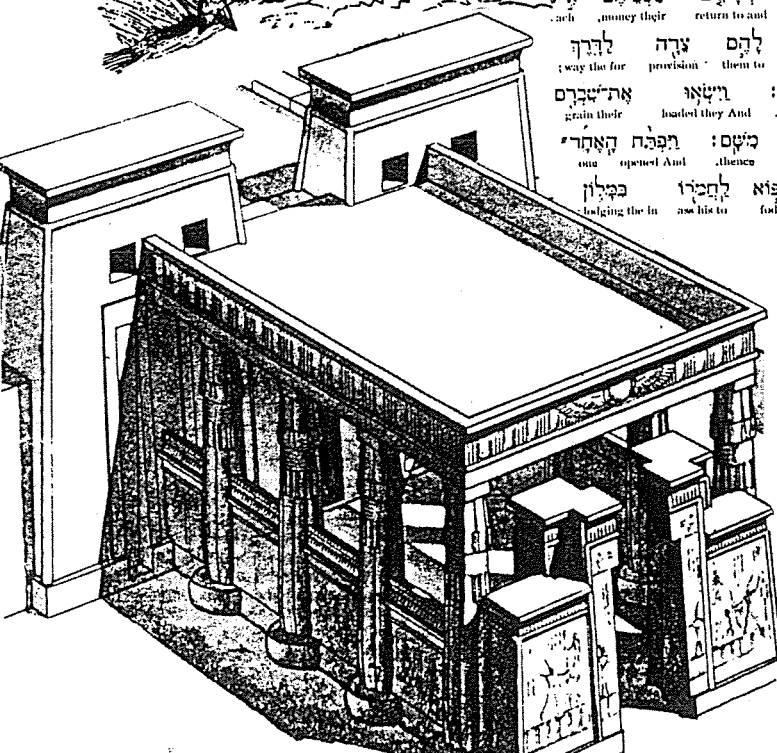

# Table of Contents

<b>INTRODUCTION</b> .....	1
<b>SYLLABUS</b> .....	1
<b>COURSE GRADING</b> .....	9
<i>Group Project Grade Sheet</i> .....	6
<i>PowerPoint Presentation Grade Sheet</i> .....	7
<i>OT Survey Course Evaluation</i> .....	9
<i>Research Paper Grade Sheet</i> .....	10
<i>Research Paper Checklist</i> .....	11
<i>PowerPoint Translation Grade Sheet</i> .....	13
<b>WHY STUDY THE OLD TESTAMENT?</b> .....	14
<b>MY BIOGRAPHICAL SKETCH</b> .....	15
<b>DIFFERENCES BETWEEN OUR CULTURES</b> .....	17
<b>OLD TESTAMENT OVERVIEW</b> .....	18
<b>THE BIBLE AT A GLANCE</b> .....	19
<i>The Seven Great Periods of History</i> .....	19
<i>Stages of God's Plan in History</i> .....	20
<i>The Abrahamic Covenant &amp; Its Fulfillment</i> .....	21
<i>Kingdom &amp; Covenants Timeline</i> .....	22
<i>The Eschatological Significance of the Sabbath</i> .....	23
<i>Government in Scripture</i> .....	24
<i>The Bible's Story</i> .....	25
<i>Overview of the Old and New Testaments</i> .....	26
<b>MAPS</b> .....	27
<i>Maps of the OT and Modern Mid-East (complete)</i> .....	27
<i>Map of the OT Mid-East (incomplete)</i> .....	28
<i>Sizes of the Mid-East and SE Asia Contrasted</i> .....	29
<i>The Geographical Old Testament</i> .....	29a
<i>The Old Testament Story</i> .....	29b
<i>Who Am I?</i> .....	29c
<i>Hermeneutical Questions of the Old Testament</i> .....	29d
<b>OLD TESTAMENT CONTENT</b> .....	30
<i>The Theme of the Old Testament</i> .....	30
<i>Kingdom, Covenants &amp; Dispensations Diagram</i> .....	34
<i>Introduction to the Old Testament</i> .....	35
<i>Structure of the Old Testament</i> .....	36
<i>Each OT Book in Three Words</i> .....	37
<i>Book Summaries of the Old Testament</i> .....	38
<i>Key Words &amp; Kingdom Statements for the OT</i> .....	39
<i>Message Statements for OT Historical Books</i> .....	41
<i>Pentateuch &amp; Historical Book Themes</i> .....	42a
<b>OLD TESTAMENT CHRONOLOGY</b> .....	43
<i>Integration of the Old Testament</i> .....	43
<i>A Family Tree from Adam to Jesus</i> .....	44
<i>Chronology of Historical and Poetical Books</i> .....	45
<b>ARRANGEMENTS OF THE OLD TESTAMENT</b> .....	46
<i>Authors of the Old Testament</i> .....	46
<i>Hebrew Bible Arrangement</i> .....	51
<i>English Bible Arrangement</i> .....	52
<i>How We Got Our Old Testament</i> .....	52a
<i>The Quest for the Original Bible</i> .....	52d
<b>OLD TESTAMENT BOOK STUDIES</b> .....	53
<b>THE PENTATEUCH</b> .....	54
<i>Introduction to the Pentateuch</i> .....	55
<i>Contrasting Books of the Pentateuch</i> .....	55a

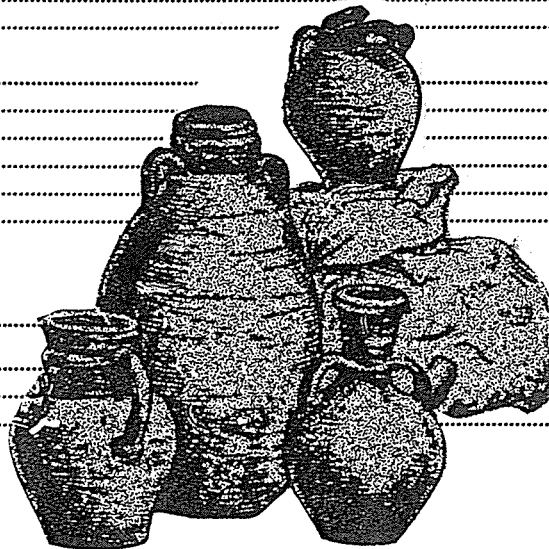

<i>Genesis</i> .....	56
Genesis 1 and Creation	
Does Genesis 1 Teach Literal Days? .....	70a
The Length of God's Rest .....	70c
How Long Were the Days of Genesis 1? .....	70e
Naming the Animals: All in a Day's Work for Adam .....	70i
Archaeological Periods .....	70n
Creation Theories .....	71
The Consummation of All Things .....	72
Biblical vs. Babylonian Creation Accounts .....	73
Creation vs. Evolution .....	74
Evolution or God's Word? .....	76
Theistic Evolution .....	78
Catholic and Evangelical Beliefs in Theistic Evolution .....	79a
Sites of Evolutionists' 'Missing Links' .....	79b
Prehistoric Intelligence .....	79c
Did Adam Speak Hebrew? .....	79d
Environmentalists and Evolution .....	79e
The Ancient Near East	
Ancient Near East Parallels to the OT .....	79f
Ancient Texts Relating to the Old Testament .....	79g
The Flood	
The Bible and Dinosaurs .....	80
Identity of the Sons of God (Gen. 6:1-2) .....	83
Biblical vs. Babylonian Flood Accounts .....	83
The Gilgamesh Epic .....	83a
Flood Legends .....	83b
Time Periods of the Flood .....	83c
Archaeology Supports Biblical Flood .....	83d
Has the CIA Finally Found Noah's Ark? .....	84
The Patriarchs	
Chronology of the Patriarchs .....	85
Timeline of the Patriarchs .....	90
Patriarchal Family Tree .....	91
Dawn of Civilizations .....	91a
Table of Nations .....	92
The Land of Abraham .....	93
Jacob's Journey and Tribes of Israel .....	94
Chart of Old Testament Patriarchs & Judges .....	95
Sons of Jacob .....	97
Genesis vs. Exodus .....	97a
<i>Exodus</i> .....	98
The Pyramids .....	105a
Hieroglyphics .....	105b
How Hieroglyphics Were Deciphered .....	105c
The Plagues and the Gods of Egypt .....	106
The Exodus	
Map of the Exodus .....	107
Egyptian Sojourn Chronologies Contrasted .....	108a
Egyptian Sojourn Chronologies Evaluated .....	108b
The Egyptian Bondage Chronology Problem .....	108c
Support for a 400-Year Egyptian Bondage Problem .....	108d
Date of the Exodus .....	109
Hebrew Calendar and Selected Events .....	111
The Location of Mount Sinai .....	111a
The Law	
Interpreting and Preaching Legal Literature .....	112
The Ten Commandments .....	113a
Should Christians Follow the Ten Commandments? .....	114
Contrasting the Abrahamic & Mosaic Covenants .....	116
Israel & the Church: Continuity & Discontinuity .....	117
The Tabernacle	
The Tabernacle and Furnishings .....	119
The Furnishings .....	119a
The Living Tabernacle .....	119b
The High Priest .....	119c
The Tabernacle & Creation .....	119d
Salvation in the Old Testament .....	119e
Israel versus Pagan Culture .....	120



<i>Leviticus</i> .....	121
The Bible and Blood .....	127a
Old Testament Sacrifices .....	128
Rituals for Levitical Offerings .....	129
Special Sacrificial Rituals .....	130
Why No Pork? (Any Other Law Questions) .....	131
Contrasting Levites and Priests .....	132
Old Testament Feasts and Other Sacred Days .....	133
Eschatology of Israel's Feasts (Lev. 23) .....	134
Leviticus vs. Numbers .....	134a
<i>Numbers</i> .....	135
Population Changes in the Wilderness .....	140
Encampment of the Tribes of Israel and Cities of Refuge .....	142
Journey of the Spies .....	142a
Israel's Early Eastern Neighbors .....	143
Israel's Early Western Neighbors .....	144
Broken People .....	145
<i>Deuteronomy</i> .....	147
Major Social Concerns in the Mosaic Covenant .....	156
Sacrifices at the High Places .....	157
Grumbling in the Wilderness .....	157a
Covenant Contrasts .....	157b
Key OT Passages about the Land .....	158
Israel's Future in Deuteronomy 28–32 .....	159
<b>BOOKS OF HISTORY</b> .....	160
<i>Introduction to the Historical Books</i> .....	161
<i>Joshua</i> .....	162
Miraculous Crossings .....	168
Battles of Joshua's Conquest .....	169
Space Scientists Discover Biblical Truth .....	169a
The Harold Hill Myth .....	169b
Conquest of Canaan .....	170
Division of Canaan .....	171
Levitic Cities and Cities of Refuge .....	171a
Issues about Jericho .....	171b
<i>Judges</i> .....	172
Joshua and Judges Contrasted .....	180
The Judges According to Their Tribes .....	180a
The Gideon Narrative as the Focal Point of Judges .....	180b
Enemies in Canaan During the Judges .....	181
Five Cities of the Philistines and Gideon's Battles .....	182
Views on Jephthah's Daughter (Judg. 12) .....	183
What is Sin? .....	184
Judges vs. Kings .....	184a
OT Book Word Search .....	184b
<i>Ruth</i> .....	185
Geography of Ruth .....	192
Theology of Ruth .....	193
<i>1 Samuel</i> .....	194
Judges' vs. Kings' Leadership .....	200
Biographical Contrast by Interchange (1 Sam. 1–12) .....	201
The Line of Aaron .....	202
The Life and Ministry of Samuel .....	202a
Saul's Military Campaigns .....	202b
The Wanderings of the Ark of the Covenant .....	203
The Battle of Michmash .....	204
Saul's Family Tree .....	205
David's Family Tree .....	206
David as Fugitive and Warrior .....	207
Saul and David Contrasted .....	208
The Philistine Threat .....	208a
Controversial Issues .....	208b
<i>2 Samuel</i> .....	209
Geography of David's Jerusalem .....	215
David's Conquests .....	216
Did God Approve of David's Polygamy? .....	217
Saul-David-Solomon Contrasts .....	218

<i>1 Kings</i> .....	219
The Divided Kingdoms .....	227a
Solomon's Temple and Furnishings .....	228
Possible Locations of Solomon's Temple .....	229
Geography of the Divided Kingdom .....	230
Chart of Old Testament Kings and Prophets .....	231
Chart of Old Testament Kings and Prophets (Blank) .....	233
Chronology of Kings and Prophets .....	234
Rulers of Israel and Judah .....	235
Kings of Israel .....	236
Kings of Judah .....	237
Genealogical Chart of the Kings of Judah .....	238
Summaries of the Kings' Reigns .....	239
Chronicles Clip #1 .....	242
Chronicles Clip #2 .....	243
Modern News Clips on Solomon .....	244
Did God Approve of Solomon's Polygamy? .....	245
Elijah's Travels .....	246
Solomon's Jerusalem, Elijah and Elisha .....	247
The Appeal of Idols .....	248
Contrasting Elijah and Elisha .....	248a
Kingdom Crossword Puzzle .....	248b
 <i>2 Kings</i> .....	 249
Assyrian Foreign Policy .....	257
Assyrian Campaigns Against Israel and Judah .....	258
Exile of the Northern Kingdom .....	259
Nebuchadnezzar's Campaign Against Judah .....	260
Exile of the Southern Kingdom .....	261
 <i>1 Chronicles</i> .....	 262
Chronicles vs. Samuel/Kings .....	267a
A Synoptic Harmony of Samuel, Kings, and Chronicles .....	267b
Chronicles Clip #3 .....	268
Patriarchal Family Tree .....	269
Family and Ancestry of David .....	270
 <i>2 Chronicles</i> .....	 271
Parallels between David's and Solomon's Transfers of the Ark .....	275
Decline of the Kingdoms .....	278
Patterns of Kings' Rule .....	279
Revivals in 2 Chronicles .....	280
Israel's Later Eastern Neighbors .....	281
Nebuchadnezzar's Six Deportations to Babylon .....	282
Babylonian Captivity .....	283
If I Forget Thee: Does Jerusalem Really Matter to Islam? .....	285
 <i>Ezra</i> .....	 289
God's Approval of Divorce under Ezra .....	294
Returns from Exile .....	295
Chronological Sequence in the Book of Ezra .....	296
Chronology of Ezra-Nehemiah .....	297
Return from Exile and Zerubbabel's Temple .....	298
 <i>Nehemiah</i> .....	 299
Jerusalem of the Returning Exiles .....	304
Nehemiah's Responses to Problems .....	305
Nehemiah's Leadership .....	306
Chronicles Clip #4 .....	307
 <i>Esther</i> .....	 308
Chronology of the Persian Period .....	313
Key Dates Related to the Book of Esther .....	314
Banquets in the Book of Esther .....	315
Map of Esther's Canonical Status .....	316
Map of the Persian Empire .....	317
Shadow and Fulfillment in the Book of Esther .....	318
 OLD TESTAMENT KEYWORD SONG .....	 319
 MIDTERM EXAM STUDY QUESTIONS .....	 326



WHY IT TOOK MOSES 40 YEARS  
TO LEAD HIS PEOPLE OUT OF  
THE WILDERNESS



WWW.NON-SECULAR.COM

ART BY UNIVERSAL PAGES ILLUSTRATE

WWW.NON-SECULAR.COM

# Introduction

## Syllabus

### I. Course Descriptions

Day School Catalogue (OT Survey): A general overview of the message of each Old Testament book, including how they relate to one other to form the whole, pertinent introductory issues (author, date, occasion, uniqueness, etc.), studies of foreign countries which affected Israel, a biblical theology of the Old Testament, and the chronological developments in the history of Israel.

This course will follow a *blended learning* approach. This means that we will survey the NT by two simultaneous means of instruction: (1) *face-to-face classroom learning* via the instructor supplemented by outside reading, as well as (2) *web-based individual learning* via three websites:

- (a) All course PowerPoint and notes can be downloaded at <http://www.biblestudydownloads.com>. This site also has the entire PPT in Chinese and Bahasa Indonesia with portions in other languages.
- (b) The web-based version of the entire course is at Internet Biblical Seminary under "Advanced Studies in the NT" at [www.internetseminary.org](http://www.internetseminary.org). Students can pay about US\$20 via credit card for this option instead of paying S\$55.30 at the SBC Book Centre for the course text.
- (c) Online quizzes and the final exam are at <https://www.sbc.edu.sg/moodle/login/index.php>. If this SBC moodle site says cookies are not enabled, then enable your cookies under "Options." If it still does not work, try <https://www.sbc.edu.sg/moodle>. Online discussions are *optional*.

To get to the SBC website, log on with your normal SBC username and password (or the password sent to you by SBC IT), and then click on the NT Survey course. Read announcements that I have posted, and then take your quiz for that week. For tech issues (e.g., getting online), contact Joshua Tew in the IT department at [joshua@sbcedu.sg](mailto:joshua@sbcedu.sg) (ext. 1509 or HP 91376504). He notes, "Based on recent experience, turning off Norton anti-virus is not effective. Somehow Norton still has some residual effect after it has been turned off. You will need to turn off 'automatic start up of Norton Antivirus during System Startup' through the Norton Antivirus Options window. After doing that, restart your computer and you should be able to access the Quiz after that. You may want to consider Avast antivirus which is free for home use and we have had much better experience with it than Norton."

### II. Course Objectives

By the end of this course the student will be familiar with...

- A. The *backgrounds* (author, date, origin, recipients, occasion, characteristics, and argument) of each of the OT books.
- B. The general *content* of the OT books, including a key word for each book.
- C. The *relevance* of each OT book to Asian culture and world mission.
- D. A general *biblical theology* of the Old Testament.
- E. Backgrounds on *foreign countries* that affected Israel.
- F. A general *chronology* of the history of Israel with corresponding key dates.

### III. Course Requirements

- A. Readings (25%): Please stay up on your readings. On each online quiz, you will report if you did your reading since the last quiz. This includes the reading for the day of the quiz.
  1. Students must take two IBS courses at Internet Biblical Seminary ([www.internetseminary.org](http://www.internetseminary.org)) called "Advanced Studies in the OT." You are already signed up under the SBC group. The content is the same as our class, but the IBS course has more detail, interactive questions, and self-check questions. Complete all 24 lessons, including the reading, interactive questions, Life Notebook, and Self Checks (closed book, Bible, & notes but grades not counted). This IBS content covers about half of my 958 pages of class notes, but we can cover only about 25% of the notes in class, so this reading will help you go deeper into each book. *Grades for the four online Unit Exams do not count for your course grade, but you may take these unit exams to*



*practice for your midterm or final exam.* To get online at internetseminary.org, login with your SBC username and the password 123456 under SBC, then go to Students > Learn > Enter My Classes (assure from your preferences/settings that your browser allows popup windows). Click on the Enter Classroom icon under the Action column. This gets you into the course. Finally, make sure to paste in your online Life Notebook each lesson number and question number so you need not type in all the questions. Your grade sheet is on page 10.

2. Buy class notes for the course or downloaded them from biblestudydownloads.com:
  - a. Volume 1 of the class notes (\$20.00 for 461 pages)
  - b. Volume 2 of the class notes distributed later in the course (\$20.00 for 497 pages)
- B. The Project (25%) for IBS learners is the Life Notebook (see the page 9b grade sheet). It is an online journal that answers thoughtful, application-oriented questions as opposed to content-based questions that are covered in the interactive IBS format. In total, the student will write over 30 pages. However, any student may substitute this with one of the following suggested projects:
  1. **Translate OTS PPT** into your native tongue in 50-70 OT slides (BCM) or 70-100 OT slides for grad students (MDiv/MABS/MAIS/MAC/GDIS/GDCS) of the course PPT (Creation PPT allowed too). At [http://biblestudydownloads.com/OT\\_Survey/OT\\_Survey.html](http://biblestudydownloads.com/OT_Survey/OT_Survey.html) you can download the files in English (50-70 slides for BCM or 70-100 slides for grad students). After the course I will upload the newly translated presentations for all to use. For more instructions, please download and read the TBB\_Translation\_Instructions.doc file at the TBB [link](#) below. Your grade sheet is on page 11.
  2. **Translate TBB** for 1 (BCM) or 2 (MDiv/MABS /MAIS/MAC/GDIS/GDCS) “The Bible...Basically” PPT presentations or Word scripts. We need help in Ao, Bisaya, Burmese, Dutch, French, Hindi, Japanese, Khmer, Kiswahili, Lotha, Malayalam, Mao, Mizo, Nepalese, Sinhala, Sumi, Tagalog, Tamil, Tangkhul, Tenyidie, Thai, Vaiphei, and Vietnamese. These should total 50-70 slides (BCM) or 70-100 slides for graduate students. At [http://biblestudydownloads.com/The\\_Bible...Basically/The\\_Bible...Basically.html](http://biblestudydownloads.com/The_Bible...Basically/The_Bible...Basically.html) will find the English TBB materials. Please download the TBB\_Translation\_Instructions.doc file at [this](#) link and read it. Other languages can be downloaded at this site too. As in the project above, I will grade you based on page 11 or 12 and then upload the newly translated presentations for all to use.
  3. **Teach** at least 4 OT books in at least 4 sessions (BCM) or at least 6 OT books in at least 6 sessions (SOC/MDiv/MABS/MACE/GDCS) to a group of 5+ people (preferably to the same adults, teens or children, though the kids should be taught the primary 3 version of the course on the OTS website [link](#)). Sessions should be about an hour and can be combined into three 2-hour parts, a day seminar, etc. You may use or edit PPT already designed for this course, or you may make your own. You are not required to develop more materials, but obviously those who work hard in this area tend to get better grades on the assignment and I would love to have what you may develop to upload for others to use in the future. Teaching can be via the pulpit, home Bible study, cell group, Sunday school class, etc. Your grade sheet is on page 13.
  4. **Teach** TBB sessions 1 (Overview), 2 (Map), 3E (Silence), 3F (Jesus), 6 (Open Bible), and 8 (NT) in “The Bible...Basically” seminar (see #2 above). BCM students may omit sessions 2 (Map) and 3E (Silence). Have your students fill in the page 9.1 (not 9.2!) evaluation on the last class session, but you should also submit to me with these a 2-page report that explains what you did, what you learned, who you taught, etc. You may teach in another language but translate all student evaluation forms for me before submitting them. I will then grade you with the Teacher Report Grade Sheet (p. 9.2), so make sure you fulfill its requirements. Completing teaching by the due date may be difficult to fit into an existing small group calendar, so there is flexibility here as long as you finish teaching by finals week. Your grade sheet is on page 13.

5. **A Research Paper** on the student's chosen OT theme (but approved by the professor) must be 6-8 double-spaced pages and written according to Turabian and SBC Writing Standards. Use footnoting, not endnotes. Plagiarism will not be tolerated and your own written work from previous papers should be cited as such. The page count does not include a title page, table of contents, and bibliography of 6-8 sources. It will be graded based on page 14 and should follow the guidelines of pages 9e-f. The topic must be broad enough to encompass at least eight OT books, such as the glory of God, redemption, the new covenant, prayer, worship, geography, some aspect of OT backgrounds that helps us understand Scripture, etc. Pick a theme in the first two weeks of the course and write on it in such a way that will show your understanding of the broad scope of OT theology and NT books.
6. **Read the entire OT** so that each OT book is fully read before we discuss it in class.

All assignments have a 3% grade penalty per class day late. Also, points may be deducted for not including your full name and box number, exceeding the page limit, bad grammar and spelling.

- D. **The Midterm (25%) & Final Exam (25%)** cover the class notes for the first half and entire course, respectively. I will **not** give any quizzes over the IBS readings.

#### IV. Course Grading

As students take this course at 4 different levels, the grading requirements vary accordingly:

	BCM	GDCS	Certificate (Eve. Sch.)	Audit (Eve. Sch.)
IBS Course	33.3%	25%	50%	--
Quizzes	--	--	50%	--
Project	--	25%	--	--
Midterm Exam	33.3%	25%	--	--
Final Exam	33.3%	25%	--	--
Total	100%	100%	100%	No grade or credit
Attendance	90+%	90+%	70+%	No Minimum

#### V. Course Bibliography and Abbreviations (underlined)

- \* Books with an asterisk are on reserve in the library.  
 † Books with a cross as well include required readings.

Alexander, T. Desmond. *From Paradise to Promised Land: An Introduction to the Main Themes of the Pentateuch*. Carlisle, UK: Paternoster, 1995. 227 pp.

Covers major themes in the Pentateuch in a simplified manner without getting bogged down addressing hypothetical source theories; readable, helpful maps and diagrams; unfortunately sees no reason for Israel to possess Canaan in the future (p. 30).

†\*Arnold, Bill T. and Beyer, Bryan E. *Encountering the Old Testament: A Christian Survey*. Grand Rapids: Baker, 1999. \$64.00 hb. (with SBC discount) + CD-ROM. 512 pp.

A first year Bible college OT survey in an attractive format of simple text, graphics, backgrounds, colour photographs, and an interactive CD with video clips, photos, maps, and review questions. The authors teach at Asbury and Columbia, respectively.

\_\_\_\_\_. *Readings from the Ancient Near East: Primary Sources for Old Testament Study*. Grand Rapids: Baker, 2002. 240 pp. Pb. \$21.99.

Master's level texts (e.g., from Mesopotamia) in canonical order to supplement the OT.

**BDB**: Gesenius, William. *The New Brown-Driver-Briggs-Gesenius Hebrew and English Lexicon*. Trans., Edward Robinson. Rev. and augmented by Francis Brown with S. R. Driver and Charles A. Briggs. N.p., 1906; reprint, Peabody, MA: Hendrickson, 1979.



BDB is the standard OT lexicon for Hebrew/Aramaic studies, gives brief translations and selected verses for each translation, and includes words from related languages (Aramaic, Assyrian, Arabic, etc.). This edition of BDB is called "New" as it has the Strong/NASB numbering system throughout as well as in an index for those who do not know Hebrew.

†\*Beitzel, Barry J. *The New Moody Atlas of Bible Lands*. 2<sup>nd</sup> ed. Chicago: Moody, 2009. xii+304 pp. SBC Book Centre for S\$71.65 (with student discount).

This major revision of *The Moody Atlas of Bible Lands* (1986) retains the strengths of being evangelical, excellent in both physical geography and historical geography with maps superior to *The NIV Atlas* below, and maps nicely tied in with the text. It also improves on it with many color photographs, 23 new maps, 48 pages of added commentary, plus Scripture and General Indexes. These maps appear in the NLT, ESV, and NIV Study Bibles. However, the revised edition still retains two weaknesses of the first edition: no regional maps and few Scripture references on the maps (though cited in supporting material). Beitzel teaches OT at Trinity International Univ. (TEDS) in Deerfield, IL.

\*Benware, Paul N. *Survey of the Old Testament*. Rev. ed. Everyman's Bible Commentary. Chicago: Moody, 1988, 1993. 318 pp.

Evangelical, concise, chronological, and readable discussions of each OT book on the theme of the covenant promises to Israel. A good entry-point for understanding the OT.

\*BKC: *The Bible Knowledge Commentary*. 2 vols. Eds. John F. Walvoord and Roy B. Zuck. Wheaton: SP Pub., Victor Books, 1983 (NT, 991 pp.), 1985 (OT, 1589 pp.).

The best single buy in a Bible commentary, based on NIV, excellent book outlines, maps, charts, cross references, book introductions, evangelical, gives special attention to difficult texts (in contrast to many single volume commentaries which skim or skip controversial texts), theologically consistent (whereas most single volume commentaries are by authors of various theological persuasions and thus have inconsistent data, all BKC authors are present or former faculty of Dallas Seminary, making it theologically consistent). This set is also available in Chinese, French, German, Hungarian, Italian, Korean, Russian, and Spanish with portions in Hindi, Thai, and Sinhalese.

Bright, John. *A History of Israel*. 4<sup>th</sup> ed. Intro and appendix by William P. Brown. Philadelphia: Westminster, 2000. US\$34.95 hb.

A standard critical OT text which says that Israel's faith shaped the course of the people's story (e.g., the exodus account was invented to increase the Jews' faith).

Cross, John R. *The Stranger on the Road to Emmaus*. Sanford, FL: Good Seed, 1996. 318 pp.

Historical presentation of the gospel by a New Tribes missionary to Papua New Guinea. Has excellent illustrations which supplement these notes.

\*Fee, Gordon D., and Stuart, Douglas. *How to Read the Bible for All Its Worth*. Grand Rapids: Zondervan, 1982; London: Scripture Union, 1983.

Excellent insights on the types of scriptural literature. Not a detailed work on each book.

\*Gospel Light Pub. *Reproducible Maps, Charts, Timelines & Illustrations*. Originally *The Bible Visual Resource Book: For Do-It-Yourself Scholars*. Ventura, CA: Gospel Light, 1989. 287 pp. pb.

Great line drawings for classroom use. Written by Keith Kaynor (?—his name is not mentioned).

\*Griffith, Rick. *Reference Books and Commentaries You Should Buy*. 3d ed. Singapore: By the author, April 2000. 68 pp. S\$5.00 in the SBC Book Centre.

My study of 500+ of what I consider the best 5-12 commentaries on each biblical book, plus the best reference books to buy. This may help you choose which sources to look up for the assignments in SBC Bible courses. It may also save you money buying books for the long-term. I use this instead of including commentary info in the notes.

- \*Hall, Terry. *Bible Panorama*. Wheaton: SP Pub., Victor, 1983.  
A practical guide with many diagrams, fill-in charts, and line drawings. Out of print. Hall is a Christian Education expert at Moody Bible Institute.
- \*Harrison, R. K. *Introduction to the Old Testament*. Grand Rapids: Eerdmans, 1969. 1325 pp.  
A massive evangelical OT introduction with even over 100 pages of comment on the various Apocryphal books, and chapters on evolution, Hebrew poetry, chronology, evangelical responses to higher criticism, etc. Takes an inductive approach including brief outlines and the message of each OT book. Harrison is Professor of Old Testament at Wycliffe College, University of Toronto.
- Hill, Andrew E. and Walton, John H. *A Survey of the Old Testament*. Grand Rapids: Zondervan, 1991. 461 pp.  
Conservative; helpful maps, charts, questions for further study and discussion; holds an early date for the Exodus, but too brief outlines and questions Solomonic authorship of Ecclesiastes. The authors teach at Wheaton College and Moody Bible Institute, respectively.
- Hoerth, Alfred J.; Mattingly, Gerald L.; and Yamauchi, Edwin M., eds. *Peoples of the Old Testament World*. Grand Rapids: Baker, 1994. 400 pp.  
Conservative articles on 14 OT peoples (20-30 pages each, with many pictures, diagrams, bibliographies, and extensive subject index) from Mesopotamia (Sumerians, Babylonians, Assyrians, Persians), Anatolia, Syria-Palestine and Egypt (Hittites, Canaanites and Amorites, Phoenicians, Arameans, Philistines, Egyptians), and Transjordan (Ammonites, Moabites, and Edomites). Hoerth is Director of Archaeology at Wheaton College.
- \*Huddleston, Barry. *The Acrostic Summarized Bible*. Atlanta: Walk Thru The Bible Press, and Nashville, TN: Nelson, 1978; reprint, Grand Rapids: Baker, 1992.  
Creative cartoons used in this course and acrostic memory aids for each book of the Bible.
- \*Jensen, Irving L. *Jensen's Bible Study Charts*. Chicago: Moody, 1981. SBC 220.97 JEN  
Includes 153 very helpful charts for each book of the Bible and more.
- \* \_\_\_\_\_ . *Jensen's Survey of the Old Testament*. Chicago: Moody, 1978. 488 pp.  
A beginner's guide in how to study the OT books. Contains many helpful charts.
- \*LaSor, William Sanford; Hubbard, David Allen; and Bush, Frederic William. *Old Testament Survey: The Message, Form, and Background of the Old Testament*. Grand Rapids: Eerdmans, 1982. 696 pp.  
SBC 221.61 LAS  
Clear, nicely footnoted scholarship by three OT professors at Fuller Theological Seminary, but attempts to be conservative without adhering to inerrancy and holds to a 4th or 5th century date for Daniel, denies Solomonic authorship of Ecclesiastes and Song of Songs, adheres to a late date for the Exodus and non-Mosaic authorship of the Pentateuch.
- Mears, Henrietta C. *A Look at the Old Testament*. Glendale, CA: Gospel Light, 1966.  
Another beginner's guide in how to study the OT books.
- \*Merrill, Eugene H. *Kingdom of Priests: A History of Old Testament Israel*. Grand Rapids: Baker, 1987. 546 pp. S\$40.00 at SBC Book Centre. SBC library 221.95 MER  
An up-to-date and well-written treatment of OT history with particular emphasis on Israel's responsibility to be a light to the nations. Dr. Merrill teaches OT at Dallas Seminary (dispensational premillennial). Supplemented with several helpful indexes.
- Ollenburger, Ben C.; Martens, Elmer A.; and Hasel, Gerhard F., eds. *The Flowering of Old Testament Theology: A Reader in Twentieth-Century Old Testament Theology, 1930-1990*. Sources for Biblical and Theological Study, vol. 1. Winona Lake, Indiana: Eisenbrauns, 1992. 547 pp.  
Mostly samples of OT theology by various authors, but also includes articles on the future of OT theology and an appendix distinguishing biblical from dogmatic theology.

Schultz, Samuel J. *The Old Testament Speaks*. 5th ed. New York: Harper & Row, 1960, 1970, 1980, 1990, 2000. 440 pp.

Conservative archaeological and historical OT survey with good attention to backgrounds. Holds to undated creation (p. 13), either global or local flood that killed all mankind (p. 16), and early date for the Exodus (p. 49). Schultz taught Bible and theology at Wheaton College for many years. He often presents alternate views but holds his own with reserve. This book is translated into more than 20 languages, including Arabic, Chinese, Japanese, Korean, Thai, and Urdu.

\*Walton, John H. *Chronological and Background Charts of the Old Testament*. Rev. & expanded. Grand Rapids: Zondervan, 1978, 1994. 124 pp.

Provides over 100 OT charts. Many are used in this course and about 20 are provided in a separate packet as overhead transparencies in the first edition.

Wilkinson, Bruce. *Walk Thru the Old Testament Bible Survey Seminar Notebook*. Atlanta, GA: Walk Thru The Bible Ministries, 1978.

Very helpful charts and maps. Note: Although photocopied Walk Thru materials used in this course may say "do not reproduce," approval to duplicate them has been granted as they are not for profit and clearly identified as Walk Thru materials.

\*TTTB: Wilkinson, Bruce, and Boa, Kenneth. *Talk Thru the Bible*. Nashville: Nelson, 1983. 522 pp.

A very practical guide to the whole Bible by book from a dispensational perspective. Contains many helpful charts and maps. Highly recommended!

BTOT: Zuck, Roy B., ed. *A Biblical Theology of the Old Testament*. Chicago: Moody, 1991. \$37.80 in SBC Book Centre (with student discount).

A concise and well-written treatment of how theological ideas within each OT book support a kingdom theme in which God's purpose is to re-establish His rule on earth through mankind which was lost at the Fall. Chapters are written by faculty members of Dallas Theological Seminary. Insightful though not necessarily light reading.

## VI. Readings and Quizzes Schedule (GDCS Tuesday Nights)

Session	Date/Day	Biblical Books	IBS Reading & Assignments
1	15 July (T1)	Syllabus	
2	15 July (T2)	Introduction	
3	15 July (T3)	Biblical Theology	
4	22 July (T1)	Biblical Geography	Lesson 1: An Overview of the OT
5	22 July (T2)	<b>Pentateuch</b>	
6	22 July (T3)	Genesis Overview	
7	29 July (T1)	Genesis 1–2	Lesson 2: Pentateuch & Genesis
8	29 July (T2)	Genesis 3–11	
9	29 July (T3)	Genesis 12–50	
10	5 Aug (T1)	Exodus	Lesson 3: Exodus
11	5 Aug (T2)	Leviticus	Lesson 4: Leviticus & Numbers
12	5 Aug (T3)	Numbers	
13	12 Aug (T1)	Deuteronomy	Lesson 5: Deuteronomy & Joshua
14	12 Aug (T2)	Joshua	
15	12 Aug (T3)	Judges/Ruth	Lesson 6: Judges & Ruth
16	19 Aug (T1)	1 Samuel	Lesson 7: 1 & 2 Samuel
17	19 Aug (T2)	2 Samuel 1 Chronicles	
18	19 Aug (T3)	1 Kings 2 Chron. 1–21	Lesson 8: 1 & 2 Kings
19	26 Aug (T1)	2 Kings 2 Chron. 22–36	Lesson 9: 1 & 2 Chronicles <b>Take online midterm by midnight 25 Aug</b>
20	26 Aug (T2)	<b>Wisdom Lit.</b> Job	Lesson 10: Wisdom Literature & Psalms Bring \$20 for OTS, vol. 2
21	26 Aug (T3)	Psalms	
22	2 Sep (T1)	Song of Songs	
23	2 Sep (T1)	Proverbs	Lesson 11: Job & Proverbs
24	2 Sep (T3)	Ecclesiastes	Lesson 12: Ecclesiastes & Song of Sol.
<b>9 Sep</b>		<b>Mid-Semester</b>	<b>No class or assignments</b>



25	16 Sep (T1)	<b>Prophets</b> Obadiah	Enroll in Advanced Studies in OT 2 (ot-703) Lesson 1: Prophetic Literature & Obadiah
26	16 Sep (T1)	Jonah	Lesson 2: Jonah & Amos
27	16 Sep (T3)	Amos	
28	23 Sep (T1)	Hosea	Lesson 3: Hosea & Micah
29	23 Sep (T1)	Isaiah	Lesson 4: Isaiah
30	23 Sep (T3)	Micah	
31	30 Sep (T1)	Nahum Habakkuk	Lesson 5: Nahum & Habakkuk
32	30 Sep (T1)	Zephaniah	Lesson 6: Joel & Zephaniah
33	30 Sep (T3)	Joel	
34	7 Oct (T1)	Jeremiah & Lamentations	Lesson 7: Jeremiah & Lamentations
35	7 Oct (T2)	Daniel	Lesson 8: Daniel
37	7 Oct (T3)	Ezekiel	Lesson 9: Ezekiel
38	14 Oct (T1)	Ezra	Bring OTS, vols. 1-2 to class Lesson 10: Ezra 1-6, Haggai, & Zechariah
39	14 Oct (T2)	Esther	Lesson 11: Esther & Ezra 7-10
40	14 Oct (T3)	Haggai	
41	21 Oct (T1)	Zechariah	<b>Project Due</b> Bring OTS, vols. 1-2 to class
42	21 Oct (T2)	Nehemiah	Lesson 12: Nehemiah & Malachi
43	21 Oct (T3)	Malachi	
	27-31 Oct	Study week	Review Final Exam Study Sheet & Pray
	3-6 Nov	Final Exam	Review Final Exam Study Sheet & Pray <b>Take online final by midnight 6 November</b>

## VII. Other Matters

- A. Contacting Me: You can contact me at SBC by box L19 or by phone (6559-1513). Also, my home is at Block 2-302 on the SBC campus, mobile is 9113-7090, and email at griffith@sbc.edu.sg. My office hours when I can talk are from 11:00-1:00 on Tuesday and Wednesday and afternoons on Friday. Let's have lunch too!
- B. Copying Class Notes: This is allowed as long as you give credit where credit is due and until you become rich from doing it. Taping class lectures is OK too.
- C. Course Design: A survey of the Old Testament can be studied at least three ways:
- a) **Sequence** (Scriptural) is used by Wilkinson & Boa. This way studies the books in the order they appear in the Old Testament. Pages 34, 36, and 52 illustrate this.
  - b) **Author** (Biographical) is also possible. This method addresses together all books by Moses, then by Joshua, etc. The study beginning at page 46 does this.
  - c) **Time** (Chronological) is used by the *Bible Visual Resource Book* (p. 45). We will follow this method to see OT books in their historical context by placing the various prophetic writings within the historical books. Page 43 serves as our outline for this course.
- D. Potential Research Paper Topics: The choice of subject is up to the student in consultation with the lecturer. However, any one of these suggested topics can also be addressed:
1. Trace the redemption theme through the OT by showing what the OT teaches about the salvation of individuals.
  2. What does the OT teach concerning Israel's restoration? What aspects of this restoration are already fulfilled?
  3. Address another topic in the OT as a whole (or at least a major part of it), such as biomedical ethics, ecology, government, poverty alleviation, the spirit world, healing, music, worship, the Messiah's reign, etc.).

## VIII. Course Load

- A. The expected study time for this course is 45 sessions x 3 hours each = 90 hours
- B. The breakdown for the course components is:

24 IBS Lessons x 3 hours each	72 hours
Project included in IBS	
Midterm Exam	5 hours
<u>Final Exam</u>	<u>5 hours</u>
Totals	82 hours

## IBS Life Notebook Grade Sheet (OTS Edition)

Student \_\_\_\_\_ Mailbox \_\_\_\_\_ Project Grade \_\_\_\_\_

For students taking the online Internet Biblical Seminary Course, the first four sections below cover the Life Notebook *content* (70% of the grade). The Format grade (the other 30%) addresses English grammar, clarity of writing and presentation, etc. In general, students need to write at least 20 pages for a B and 30 pages for an A grade. Students must answer all questions in the two Life Notebooks but submit them as a single digital file.

	1	2	3	4	5
	Poor	Minimal	Average	Good	Excellent
<b><u>Clarity</u></b>					
<b>Direct</b> (each answer addresses the proper question)	<input type="checkbox"/>	<input type="checkbox"/>	<input type="checkbox"/>	<input type="checkbox"/>	<input type="checkbox"/>
<b>Specifics</b> given rather than general answers	<input type="checkbox"/>	<input type="checkbox"/>	<input type="checkbox"/>	<input type="checkbox"/>	<input type="checkbox"/>
<b>Color</b> of questions is in red and answers in black	<input type="checkbox"/>	<input type="checkbox"/>	<input type="checkbox"/>	<input type="checkbox"/>	<input type="checkbox"/>
<b><u>Quality</u></b>					
<b>Wide research</b> (interacts with other views & sources)	<input type="checkbox"/>	<input type="checkbox"/>	<input type="checkbox"/>	<input type="checkbox"/>	<input type="checkbox"/>
<b>Individual work</b> (no more than 10% quotations)	<input type="checkbox"/>	<input type="checkbox"/>	<input type="checkbox"/>	<input type="checkbox"/>	<input type="checkbox"/>
<b>Development</b> (proves points, not just lists verses)	<input type="checkbox"/>	<input type="checkbox"/>	<input type="checkbox"/>	<input type="checkbox"/>	<input type="checkbox"/>
<b>Interpretation</b> of passages accurate (exegesis)	<input type="checkbox"/>	<input type="checkbox"/>	<input type="checkbox"/>	<input type="checkbox"/>	<input type="checkbox"/>
<b><u>Application</u></b>					
<b>Action Points</b> apply the content to the student's life	<input type="checkbox"/>	<input type="checkbox"/>	<input type="checkbox"/>	<input type="checkbox"/>	<input type="checkbox"/>
<b>Follow up</b> from previous action points highlighted	<input type="checkbox"/>	<input type="checkbox"/>	<input type="checkbox"/>	<input type="checkbox"/>	<input type="checkbox"/>
<b>Personal</b> and transparent answers (self critical is good)	<input type="checkbox"/>	<input type="checkbox"/>	<input type="checkbox"/>	<input type="checkbox"/>	<input type="checkbox"/>
<b><u>Miscellaneous</u></b>					
<b>Critical Thinking</b> (shows how/why student disagrees)	<input type="checkbox"/>	<input type="checkbox"/>	<input type="checkbox"/>	<input type="checkbox"/>	<input type="checkbox"/>
<b>Depth</b> (answers all questions with sufficient depth)	<input type="checkbox"/>	<input type="checkbox"/>	<input type="checkbox"/>	<input type="checkbox"/>	<input type="checkbox"/>
<b>Length</b> (5-10 lines/question, 30+ single-spaced pages)	<input type="checkbox"/>	<input type="checkbox"/>	<input type="checkbox"/>	<input type="checkbox"/>	<input type="checkbox"/>
<b>Overall content</b> (substance rather than filling space)	<input type="checkbox"/>	<input type="checkbox"/>	<input type="checkbox"/>	<input type="checkbox"/>	<input type="checkbox"/>
<b><u>Format</u></b>					
<b>Submitted</b> via email in Word & pages numbered	<input type="checkbox"/>	<input type="checkbox"/>	<input type="checkbox"/>	<input type="checkbox"/>	<input type="checkbox"/>
<b>Flow</b> and readability of content	<input type="checkbox"/>	<input type="checkbox"/>	<input type="checkbox"/>	<input type="checkbox"/>	<input type="checkbox"/>
<b>Spelling</b> and typos fixed, punctuation good, 12 pt. font	<input type="checkbox"/>	<input type="checkbox"/>	<input type="checkbox"/>	<input type="checkbox"/>	<input type="checkbox"/>
<b>Grammar</b> shows agreement of subject/verb & tenses	<input type="checkbox"/>	<input type="checkbox"/>	<input type="checkbox"/>	<input type="checkbox"/>	<input type="checkbox"/>
<b>Citations</b> given in footnotes instead of endnotes	<input type="checkbox"/>	<input type="checkbox"/>	<input type="checkbox"/>	<input type="checkbox"/>	<input type="checkbox"/>
<b>Sections</b> clearly stated without orphan headings	<input type="checkbox"/>	<input type="checkbox"/>	<input type="checkbox"/>	<input type="checkbox"/>	<input type="checkbox"/>
<b><u>Summary</u></b>					
Number of ticks per column	_____	_____	_____	_____	_____
Multiplied by point values of the column	<b>x 1</b>	<b>x 2</b>	<b>x 3</b>	<b>x 4</b>	<b>x 5</b>
Equals the total point value for each column	_____	_____	_____	_____	_____

Net points \_\_\_\_\_ minus 3 points per day late (\_\_\_\_\_ points) for Life Notebook grade: \_\_\_\_\_%

**Comments:**

## PowerPoint Translation Grade Sheet

Student \_\_\_\_\_ Mailbox \_\_\_\_\_ Date \_\_\_\_\_  
 Bible Book or Presentation Translated \_\_\_\_\_ Language \_\_\_\_\_

	1	2	3	4	5
	Poor	Minimal	Average	Good	Excellent

### Translation

- |  |                          |                          |                          |                          |                          |
|--|--------------------------|--------------------------|--------------------------|--------------------------|--------------------------|
| Overall content translated accurately  | <input type="checkbox"/> | <input type="checkbox"/> | <input type="checkbox"/> | <input type="checkbox"/> | <input type="checkbox"/> |
| No English on any slide (design new memory aids)<br><small>--For example, replace "A Judge Must Judge" or "ARC" with a mnemonic in your language</small> | <input type="checkbox"/> | <input type="checkbox"/> | <input type="checkbox"/> | <input type="checkbox"/> | <input type="checkbox"/> |

### Fonts

- |  |                          |                          |                          |                          |                          |
|--|--------------------------|--------------------------|--------------------------|--------------------------|--------------------------|
| Notes page # in Arial bold 24 point upper right screen | <input type="checkbox"/> | <input type="checkbox"/> | <input type="checkbox"/> | <input type="checkbox"/> | <input type="checkbox"/> |
| Generic fonts or popular language fonts (e.g, unicode) | <input type="checkbox"/> | <input type="checkbox"/> | <input type="checkbox"/> | <input type="checkbox"/> | <input type="checkbox"/> |
| Sans-serif fonts used that lack "feet" (e.g., Arial)   | <input type="checkbox"/> | <input type="checkbox"/> | <input type="checkbox"/> | <input type="checkbox"/> | <input type="checkbox"/> |

### Text

- |   |                          |                          |                          |                          |                          |
|---|--------------------------|--------------------------|--------------------------|--------------------------|--------------------------|
| Text <b>does not overlap</b> other text, image, or page edge    | <input type="checkbox"/> | <input type="checkbox"/> | <input type="checkbox"/> | <input type="checkbox"/> | <input type="checkbox"/> |
| Text <b>shadow</b> not seen prior to animation appears          | <input type="checkbox"/> | <input type="checkbox"/> | <input type="checkbox"/> | <input type="checkbox"/> | <input type="checkbox"/> |
| Text <b>did not need to be enlarged</b> (should fill the slide) | <input type="checkbox"/> | <input type="checkbox"/> | <input type="checkbox"/> | <input type="checkbox"/> | <input type="checkbox"/> |
| Text has <b>good contrast</b> with background                   | <input type="checkbox"/> | <input type="checkbox"/> | <input type="checkbox"/> | <input type="checkbox"/> | <input type="checkbox"/> |
| Text <b>fits text boxes</b> correctly with extra space on sides | <input type="checkbox"/> | <input type="checkbox"/> | <input type="checkbox"/> | <input type="checkbox"/> | <input type="checkbox"/> |
| Text box <b>colors match</b> surroundings w/o perimeter lines   | <input type="checkbox"/> | <input type="checkbox"/> | <input type="checkbox"/> | <input type="checkbox"/> | <input type="checkbox"/> |

### Images

- |  |                          |                          |                          |                          |                          |
|--|--------------------------|--------------------------|--------------------------|--------------------------|--------------------------|
| Images <b>do not overlap</b> text or edge of page        | <input type="checkbox"/> | <input type="checkbox"/> | <input type="checkbox"/> | <input type="checkbox"/> | <input type="checkbox"/> |
| Embedded text in <b>English covered</b> with translation | <input type="checkbox"/> | <input type="checkbox"/> | <input type="checkbox"/> | <input type="checkbox"/> | <input type="checkbox"/> |

### Miscellaneous

- |   |                          |                          |                          |                          |                          |
|---|--------------------------|--------------------------|--------------------------|--------------------------|--------------------------|
| Format of fonts & background colors same as English             | <input type="checkbox"/> | <input type="checkbox"/> | <input type="checkbox"/> | <input type="checkbox"/> | <input type="checkbox"/> |
| Animations don't need correction; in PPT, not Keynote           | <input type="checkbox"/> | <input type="checkbox"/> | <input type="checkbox"/> | <input type="checkbox"/> | <input type="checkbox"/> |
| Slide order remains the same as the English version             | <input type="checkbox"/> | <input type="checkbox"/> | <input type="checkbox"/> | <input type="checkbox"/> | <input type="checkbox"/> |
| Done right the first time (no email trail with me!)             | <input type="checkbox"/> | <input type="checkbox"/> | <input type="checkbox"/> | <input type="checkbox"/> | <input type="checkbox"/> |
| File name <i>translated</i> with dash & number of slides at end | <input type="checkbox"/> | <input type="checkbox"/> | <input type="checkbox"/> | <input type="checkbox"/> | <input type="checkbox"/> |
| Easy transfer by CD or Memory Key or Email                      | <input type="checkbox"/> | <input type="checkbox"/> | <input type="checkbox"/> | <input type="checkbox"/> | <input type="checkbox"/> |
| Sent as one PowerPoint file (not separate ones or a pdf)        | <input type="checkbox"/> | <input type="checkbox"/> | <input type="checkbox"/> | <input type="checkbox"/> | <input type="checkbox"/> |

### Summary

Number of ticks per column	_____	_____	_____	_____	_____
Multiplied by point values of the column	x 1	x 2	x 3	x 4	x 5
Equals the total point value for each column	_____	_____	_____	_____	_____

Net points \_\_\_\_\_ minus 3 points per day late (\_\_\_\_\_ points) equals % grade of \_\_\_\_\_%

**Comments:**

Revised 5 May 2014



## “The Bible...Basically” Script Translation Grade Sheet

Student \_\_\_\_\_ Mailbox \_\_\_\_\_ Date \_\_\_\_\_

Presentation Translated \_\_\_\_\_ Language \_\_\_\_\_

	1	2	3	4	5
	Poor	Minimal	Average	Good	Excellent

**Translation**

Overall content translated accurately	<input type="checkbox"/>	<input type="checkbox"/>	<input type="checkbox"/>	<input type="checkbox"/>	<input type="checkbox"/>
No English on any slide (design new memory aids) <small>--For example, replace “A Judge Must Judge” or “ARC” with a mnemonic in your language</small>	<input type="checkbox"/>	<input type="checkbox"/>	<input type="checkbox"/>	<input type="checkbox"/>	<input type="checkbox"/>

**Fonts & Formatting**

Slide Advance Hashes retained	<input type="checkbox"/>	<input type="checkbox"/>	<input type="checkbox"/>	<input type="checkbox"/>	<input type="checkbox"/>
Consistent Fonts (e.g., Unicode or generic/popular)	<input type="checkbox"/>	<input type="checkbox"/>	<input type="checkbox"/>	<input type="checkbox"/>	<input type="checkbox"/>
Format of headings and margins same as English	<input type="checkbox"/>	<input type="checkbox"/>	<input type="checkbox"/>	<input type="checkbox"/>	<input type="checkbox"/>
Widow headings avoided	<input type="checkbox"/>	<input type="checkbox"/>	<input type="checkbox"/>	<input type="checkbox"/>	<input type="checkbox"/>

**Misc**

Done right the first time (no email trail with me!)	<input type="checkbox"/>	<input type="checkbox"/>	<input type="checkbox"/>	<input type="checkbox"/>	<input type="checkbox"/>
File name <i>translated</i> with dash & number of slides at end	<input type="checkbox"/>	<input type="checkbox"/>	<input type="checkbox"/>	<input type="checkbox"/>	<input type="checkbox"/>
Easy transfer by CD or Memory Key or Email	<input type="checkbox"/>	<input type="checkbox"/>	<input type="checkbox"/>	<input type="checkbox"/>	<input type="checkbox"/>
Sent as one Word file (not separate ones or a pdf)	<input type="checkbox"/>	<input type="checkbox"/>	<input type="checkbox"/>	<input type="checkbox"/>	<input type="checkbox"/>

**Summary**

Number of ticks per column	_____	_____	_____	_____	_____
Multiplied by point values of the column	x 2	x 4	x 6	x 8	x 10
Equals the total point value for each column	_____	_____	_____	_____	_____

Net points \_\_\_\_\_ minus 3 points per day late (\_\_\_\_\_ points) equals % grade of \_\_\_\_\_%

**Comments:**

Revised 5 May 2014

SINGAPORE BIBLE COLLEGE

**OT Survey or The Bible...Basically Evaluation of Teacher**

PLACE OF COURSE: .....

CLASS SIZE: .....

SBC STUDENT TEACHER: .....

DATE: .....

**Please summarize how you feel about each question and give this to your teacher.**

KEY: SD = Strongly Disagree; D = Disagree; U = Uncertain; A = Agree; SA – Strongly Agree.

	SD	D	U	A	SA
The course objectives were clearly explained.					
The course objectives were achieved.					
The teacher was well prepared for each class.					
The course material was effectively presented.					
The methods of assessment were appropriate.					
The teacher responded well to students' questions.					
The teacher encouraged students to think for themselves and to express their ideas.					
The teacher was accessible to students outside classes.					
TOTAL					

**GENERAL COMMENTS:**

1. In what ways did you find this course helpful for your personal spiritual growth?
  
2. In what ways did you consider this course to be helpful for your ministry?
  
3. In what ways did you think this course could be improved for future students?
  
4. Further comments:

## Research Paper Grade Sheet

Student \_\_\_\_\_ Topic \_\_\_\_\_ Box \_\_\_\_\_

The first four sections below cover the paper's *content* (70% of the grade). The Form grade (the other 30%) is based on Kate L. Turabian, *A Manual for Writers of Term Papers, Theses, and Dissertations*, 8<sup>th</sup> ed. (Chicago: Univ. of Chicago Press, 2013). Follow also the *SBC Writing Standards 2014-ed. 12* and the checklist on the next two pages.

	1	2	3	4	5
	Poor	Minimal	Average	Good	Excellent
<b><u>Introduction</u></b>					
<b>Purpose</b> (the paper addresses what issue?)	<input type="checkbox"/>	<input type="checkbox"/>	<input type="checkbox"/>	<input type="checkbox"/>	<input type="checkbox"/>
<b>Scope</b> of the issue defined/narrowed down	<input type="checkbox"/>	<input type="checkbox"/>	<input type="checkbox"/>	<input type="checkbox"/>	<input type="checkbox"/>
<b>Procedure</b> for addressing the issue introduced	<input type="checkbox"/>	<input type="checkbox"/>	<input type="checkbox"/>	<input type="checkbox"/>	<input type="checkbox"/>
<b><u>Body</u></b>					
<b>Wide research</b> (other views, good sources)	<input type="checkbox"/>	<input type="checkbox"/>	<input type="checkbox"/>	<input type="checkbox"/>	<input type="checkbox"/>
<b>Individual work</b> (no more than 20% quotations)	<input type="checkbox"/>	<input type="checkbox"/>	<input type="checkbox"/>	<input type="checkbox"/>	<input type="checkbox"/>
<b>Key passages</b> addressed adequately	<input type="checkbox"/>	<input type="checkbox"/>	<input type="checkbox"/>	<input type="checkbox"/>	<input type="checkbox"/>
<b>Development</b> (proves points, not just lists verses)	<input type="checkbox"/>	<input type="checkbox"/>	<input type="checkbox"/>	<input type="checkbox"/>	<input type="checkbox"/>
<b>Interpretation</b> of passages accurate (exegesis)	<input type="checkbox"/>	<input type="checkbox"/>	<input type="checkbox"/>	<input type="checkbox"/>	<input type="checkbox"/>
<b><u>Conclusion</u></b>					
<b>Solution</b> given to issue raised in introduction	<input type="checkbox"/>	<input type="checkbox"/>	<input type="checkbox"/>	<input type="checkbox"/>	<input type="checkbox"/>
<b>Main points</b> reviewed and/or restated	<input type="checkbox"/>	<input type="checkbox"/>	<input type="checkbox"/>	<input type="checkbox"/>	<input type="checkbox"/>
<b>Length</b> (1/2 to 1 page, w/o unnecessary info.)	<input type="checkbox"/>	<input type="checkbox"/>	<input type="checkbox"/>	<input type="checkbox"/>	<input type="checkbox"/>
<b><u>Miscellaneous</u></b>					
(These can be addressed anywhere in the paper)					
<b>Application</b> (shows why the topic is important)	<input type="checkbox"/>	<input type="checkbox"/>	<input type="checkbox"/>	<input type="checkbox"/>	<input type="checkbox"/>
<b>Depth</b> (leaves any questions unanswered?)	<input type="checkbox"/>	<input type="checkbox"/>	<input type="checkbox"/>	<input type="checkbox"/>	<input type="checkbox"/>
<b>Internet</b> not used for more than 20% of sources	<input type="checkbox"/>	<input type="checkbox"/>	<input type="checkbox"/>	<input type="checkbox"/>	<input type="checkbox"/>
<b><u>Form</u></b>					
<b>Format</b> (typed, title page, length, pages numbered)	<input type="checkbox"/>	<input type="checkbox"/>	<input type="checkbox"/>	<input type="checkbox"/>	<input type="checkbox"/>
<b>Spelling</b> and typographical errors, punctuation	<input type="checkbox"/>	<input type="checkbox"/>	<input type="checkbox"/>	<input type="checkbox"/>	<input type="checkbox"/>
<b>Grammar</b> (agreement of subject/verb and tenses)	<input type="checkbox"/>	<input type="checkbox"/>	<input type="checkbox"/>	<input type="checkbox"/>	<input type="checkbox"/>
<b>Footnoting</b> (better than endnoting; biblio. incl.)	<input type="checkbox"/>	<input type="checkbox"/>	<input type="checkbox"/>	<input type="checkbox"/>	<input type="checkbox"/>
<b>Arranged logically</b> (not a collection of thoughts)	<input type="checkbox"/>	<input type="checkbox"/>	<input type="checkbox"/>	<input type="checkbox"/>	<input type="checkbox"/>
<b>Sections</b> clearly stated without orphan headings	<input type="checkbox"/>	<input type="checkbox"/>	<input type="checkbox"/>	<input type="checkbox"/>	<input type="checkbox"/>
<b><u>Summary</u></b>					
Number of ticks per column	_____	_____	_____	_____	_____
Multiplied by point values of the column	<b>x 1</b>	<b>x 2</b>	<b>x 3</b>	<b>x 4</b>	<b>x 5</b>
Equals the total point value for each column	_____	_____	_____	_____	_____
Net points _____ minus 3 points per day late (_____ points) equals % grade of _____%					

Comments:

14<sup>th</sup> edition (10 July 2014)

## Research Paper Checklist

\* Asterisks show the most common mistakes SBC students make on research papers. Give special attention to these areas!  
13th edition (8 July 2014)

### 1. General Format

- 1.1 The most complete and widely used format guide is Kate L. Turabian, *A Manual for Writers of Term Papers, Theses, and Dissertations*, 8th ed. rev. by John Grossman and Alice Bennett (Chicago & London: Univ. of Chicago Press, 1937, 1955, 1967, 1973, 1987, 1996, 2007, 2013). 466 pp.
- 1.2 Areas not answered by Turabian are addressed in the SBC Writing Standards (2014 edition).
- 1.3 Other issues are found in *The Chicago Manual of Style*, 16th ed. (Chicago: Editorial Benei Noaj, 2010) and *The SBL Handbook of Style: For Ancient Near Eastern, Biblical, and Early Christian Studies*, ed. Patrick H. Alexander *et al.* (Peabody, MA: Hendrickson, 1999).

### 2. Preliminaries

- 2.1 The title page should follow the typical format in Turabian.
  - 2.1.1 Only the title and the author should be in **bold** with the rest in regular text. Do *not* have all CAPS.
  - 2.1.2 Please include your mail box number after your name.
  - 2.1.3 The same size 12-point Times New Roman font should be used throughout the paper.
- 2.2 The margins should not change (e.g., should not be in outline form) but should be 2.5 cm on all sides.
- 2.3\* Include a Table of Contents.
  - 2.3.1 The Contents page should include only the first page number of each section.
  - 2.3.2 Subtitles within the Contents page should be indented.
  - 2.3.3 Note this is called a "Table of Contents" and not a "Table of Content."
  - 2.3.4 "Table of Contents" should not be an entry on the Table of Contents.
- 2.4 Page numbers should be at the top right in the preliminaries (except no number on Title Page and Table of Contents) and at the bottom centre from the first page to the end.

### 3. Body & Style

- 3.1\* Provide an introduction that summarizes the problem(s) your paper aims to answer.
- 3.2\* Check your grammar for confusion of tense, plural, verb/noun, etc. (cf. section 9)
- 3.3 Use a spell checker if you have one on your computer to avoid careless spelling mistakes.
- 3.4 Double-space the paper throughout in prose form (not outline form).
- 3.5\* Write in the third person rather than the first person ("This author..." and not "I" or "we" or "us").
- 3.6 Follow these guidelines for headings within the text:
  - 3.6.1 Headings should match your Contents page. None of your levels should appear in all capitals.
  - 3.6.2 Headings should not have periods (full stops or colons) after them.
  - 3.6.3\* Headings should not be in outline form (no "I," "II," "A," "1," "a," "-", etc.).
  - 3.6.4 Avoid widow headings (at the bottom of a page without the first sentence of a paragraph).
  - 3.6.5 Don't repeat a heading on the next page even if it covers the same section of the paper.
  - 3.6.6 Each research paper should have at least 2-3 headings or divisions.
  - 3.6.7 In short papers (6-8 pages) without chapters, make (1) main headings **bold** centred, (2) subheadings regular text centred, (3) **bold italicised** left column, (4) regular text left column, and (5) **bold** text that begins an indented paragraph. If only two levels are needed then (2) above may be skipped.
- 3.7\* Do not clutter your paper with unnecessary details that do not contribute to your purpose.
- 3.8\* Make every statement a full sentence within the text (the exception is headings).
- 3.9 Critically evaluate your sources; do not believe a heresy just because it's in print!
- 3.10 Make sure your reasoning is solid and logical.
- 3.11\* Provide a conclusion which solves/summarizes the problem addressed in the introduction

### 4. Abbreviations

- 4.1\* Do not use abbreviations or contractions in the text or footnotes (except inside parentheses).
- 4.2 Cite from 1-3 verses inside parentheses in the text but 4 or more verses in the footnotes.
- 4.3\* Use proper biblical book abbreviations with a colon between chapter and verse.
- 4.4 Do not start sentences with an Arabic number. Write "First Kings 3:16..." (not "1 Kings 3:16...").
- 4.5 Write out numbers under ten in the text (e.g., "three"); abbreviate those over ten (e.g., "45").
- 4.6 "For example" (e.g.) and "that is to say" (i.e.) are abbreviated only within parentheses and each has two periods.

### 5. Quotations

- 5.1\* When quoting word-for-word, use quotation marks and footnote the source. Do not plagiarize!
- 5.2 Use proper quotation formats with single quotation marks within double ones.
- 5.3 Indent block quotes (no quote marks) with 10-point, single-space text of five or more lines (cf. Turabian, 349).
- 5.4\* Avoid citing long texts of Scriptures or other sources so the paper mostly reflects your own thinking.
- 5.5 Provide biblical support for your position rather than simply citing your opinion.
- 5.6 If your source quotes a more original source, then quote the original in this manner: R. N. Soulen, *Handbook*, 18 (cited by Rick Griffith, *New Testament Backgrounds*, 7th ed. [SBC, 1999], 165).



## Research Paper Checklist (2 of 2)

**6. Punctuation**

- 6.1 Periods & commas go *before* quote marks and footnote numbers (e.g., “Marriage,” not “Marriage”.)
- 6.2 Periods & commas go *outside* parentheses (unless a complete sentence is within the parentheses). For example: “Jesus wept” (John 11:35). but never “Jesus wept.” (John 11:35)
- 6.3 A space should not precede a period, comma, final parenthesis, semicolon, apostrophe, or colon.
- 6.4 A space should not follow a beginning parenthesis or beginning quotation mark.
- 6.7 A space should always follow a comma and 1-2 spaces always follow a period.

**7. Footnotes**

- 7.1\* The first reference to a book includes (in this order) the author's *given* name first then family name, title (in *italics* but not in quotes), publication data in parentheses (place, colon, publisher, comma, then year), volume (if more than one), and page number (no “p.” or “pp.”). For example: Ralph Gower, *The New Manners and Customs of Bible Times* (Chicago: Moody, 1987), 233. In footnotes, use a period only *once* at the end of the citation. Indent the first line of each footnote entry.
- 7.2\* Cite later references to the same book but a different page number with only the author's family name (not given name) and new page number. For example: Gower, 166.
- 7.3 If the next citation has the same book and same page number, then type “Ibid.” (This is the Latin abbreviation for “in the same place.”) However, if a different page number is referred to, then “Ibid.” should be followed by a period and comma. For example: Ibid., 64.
- 7.4 If the next citation is by the same author but a different work, type “Idem” (Latin abbreviation for “by the same author”) and a comma before the new book. For example: Idem, *Marriage and Family*, 221.
- 7.5\* Encyclopedia, Bible dictionary, or other book entries with multiple authors under an editor should first cite the article's author, then article title within quotes, book, editor, publication data in parentheses, volume, and page. For example: P. Trutza, “Marriage,” *The Zondervan Pictorial Encyclopedia of the Bible*, 5 vols., ed. Merrill C. Tenney (Grand Rapids: Zondervan, 1975, 1976), 4:92-102. (If needed, look up the author's name after the Contents page by tracing the initials at the end of the article.)
- 7.6 Footnote numbers are raised with no parentheses and go *after* a quotation's punctuation (e.g., period).
- 7.7 Always cite your footnote numbers in sequence rather than using a former number again.
- 7.8 Use only numbers as footnote references (don't use letters or \*#@^%, etc.).
- 7.9 Cite translations in parentheses within the text rather than the footnotes—for example, “trust” (NIV).
- 7.10 Cite book, chapter, and paragraphs of primary (ancient) sources with Arabic numerals and full stops (e.g., “Josephus, *Jewish Antiquities* 18.1.3,” not “Josephus, *Jewish Antiquities*, Book XVIII, Chapter 1, Section 3”).
- 7.11 Page numbers may be added to primary sources in parentheses. For example: *War* 2.1 (Whiston, 44).

**8. Bibliography**

- 8.1 Alphabetize all sources by family name without numbering the sources.
- 8.2 Make entries single-spaced with the second line indented and with a double space between entries.
- 8.3 Do not cite an author's title in a footnote or the bibliography (no “Dr.,” “Rev.” etc.).
- 8.4 Cite book references differently than in the footnotes by including the author's *family* name first (not given name), title (in *italics* but not in quotes), publication data *without* parentheses (place, colon, publisher, comma, then year), and volume (if more than one). For example: Gower, Ralph. *The New Manners and Customs of Bible Times*. Chicago: Moody, 1987. Use full stops (not commas) after each given name, title, and date; don't use parentheses (but do use them in footnotes). Indent each line after the first line in an entry.
- 8.5\* Encyclopedia, Bible dictionary, or other book entries with multiple authors under an editor should first cite the article's author, then article title within quotes, book, editor, publication data, volume, and page. For example: Trutza, P., “Marriage,” *The Zondervan Pictorial Encyclopedia of the Bible*. Ed. Merrill C. Tenney. 5 vols. Grand Rapids: Zondervan, 1975, 1976. 4:92-102. (You may need to find the author's name after the Contents page by tracing the initials at the end of the article.)
- 8.6 Put the bibliography on a separate page rather than tagging it on the conclusion.
- 8.7 Consult as many sources as you have pages in your paper (e.g., 8 sources for an 8-page paper).
- 8.8\* Include the bibliography even if the professor has assigned the sources.
- 8.9 Primary sources should be listed under the ancient author's name, followed by the translator's name. For example: Josephus. *The Works of Josephus*. Translated by William Whiston...
- 8.10 Primary sources with several or unknown authors should be listed by editor and/or translator's name. For example: Danby, Herbert, trans. *The Mishnah*. Oxford: University, 1933.

**9. Common Grammatical and Spelling Mistakes**

- 9.1 “Respond” (verb) is used for “response” (noun). “The respond” should be “The response.”
- 9.2\* Events in biblical times should be noted in the past tense; keep your tense consistent in the same paragraph.
- 9.3 Write “BC” dates *before* “BC” but “AD” dates *after* “AD” (“AD 70” and “70 BC” but never “70 AD” or “BC 70”).
- 9.4 Always capitalize the words “Christian,” “Bible,” “Christ,” “Word of God,” and “Scripture(s).”
- 9.5 The current trend is to *avoid* capitalization, especially in the adjectives “biblical,” “scriptural,” etc.
- 9.6 Avoid words in all CAPITALS in the text (except acronyms) and *avoid* all CAPS in titles.

## My Biographical Sketch

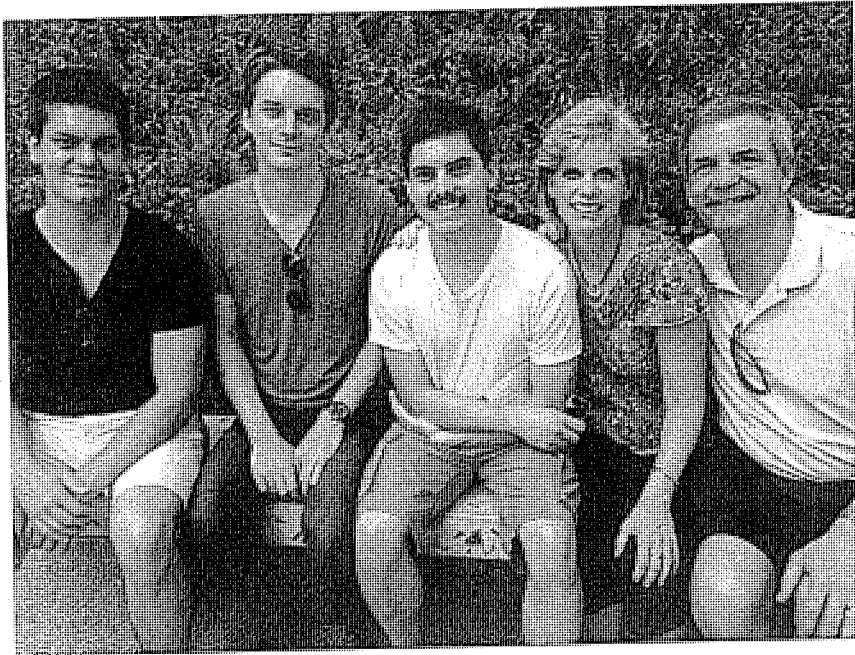

**Rick & Susan Griffith**  
Stephen (24), Kurt (27) & John (21)

### Background

“Never say ‘never.’” Rick and Susan Griffith both learned this age-old tip the hard way.

Rick recalls sitting in his elementary school classes thinking, “If there’s one thing I’ll *never* become it’s a *teacher*. Imagine saying the same stuff over and over, year after year!”

Yet after trusting Christ in junior high and acquiring a taste for teaching the Word of God, Rick’s attitude began to change. After his business degree at California State University, Hayward, and Master of Theology degree (Pastoral Ministries) and the Doctor of Philosophy degree (Bible Exposition) from Dallas Theological Seminary in Texas, Dr. Griffith soon found himself on the other end of the classroom—and loving it!

Susan, from Yucaipa, California, also learned not to say “never.” As she earned her Bachelor of Arts degree in piano at Biola University, several friends married and worked to put their husbands through three more years of seminary training. “I’ll never do that!” she exclaimed. Soon afterwards she invested three years (1981-1983) singing together with her future husband in the Crossroads, Campus Crusade’s traveling music team in Asia. This nine member Philippines-based group shared Christ in the Philippines, China, Hong Kong, Korea, Japan, Macau, Thailand, Malaysia, Indonesia, and Singapore.

In December 1983 Susan’s “never” became a reality. She and Rick were married and like Jacob and Rachel of old, Susan also worked for her mate. During these seven seminary years Rick served as a pastor, corporate chaplain, and International Students church consultant. Susan taught women’s Bible studies and often ministered by singing. Their primary church in Texas is Christ Chapel Bible Church in Fort Worth.

The Griffith family now includes three sons: Kurt (27 yrs.), Stephen (24 yrs.), and John (21 yrs.). During home assignment they minister mainly from the First Baptist Church of Yucaipa, California.

### Ministry

However, since 1991 the Griffiths’ home has been Singapore where Rick serves as Doctor of Ministry Director with 30 other full-time faculty at Singapore Bible College. SBC has about 500 full-time students from 23 countries and 25 denominations, as well as many professionals in the certificate-level Centre for Continuing Theological Education (CCTE). During his first term he taught a variety of courses: Old

Testament Survey, New Testament Survey, New Testament Backgrounds, Eschatology (the study of future things), Evangelism, Pastoral Epistles, Psalms, Homiletics (preaching), Hebrew Exegesis, and four Old Testament exposition courses. For many years he also taught Pentateuch, Gospels, Eschatology (theology of the future), Ecclesiology (theology of the church), and Pneumatology (theology of the Holy Spirit). Now he teaches mostly Bible Exposition classes, including Homiletics, World of the OT & NT, and OT & NT Survey. He has also written three Advanced Studies in the Old and New Testament courses at the Internet Biblical Seminary ([www.internetseminary.org](http://www.internetseminary.org)).

Dr. Griffith loves the variety and strategic nature of his teaching. He invests his life into Anglicans from Sri Lanka, Lutherans from Singapore, Presbyterians from Korea, Conservative Baptists from the Philippines, and missionaries from Campus Crusade, OMF, and Operation Mobilisation—sometimes all in one class! One class had 17 of the 20 students training for ministry outside of Singapore. Nearly all SBC graduates enter pastoral or missionary ministries due to Asia's shortage of trained leaders.

Ministry opportunities abound. Rick and Susan have conducted premarital counseling for students and their home has an open door to students and guests traveling through Singapore. They have sung in evangelistic thrusts and in 1992 also participated in founding International Community School, an expatriate Christian primary and secondary school in Singapore now with 430 students. The Griffiths are missionaries with WorldVenture and Rick serves as the Singapore field leader.

Dr Griffith also enjoys several other partnerships. He also serves as Asia Translation Coordinator for "The Bible... Basically International" seminars; web author & editor, Internet Biblical Seminary; and itinerate professor for 52 trips throughout Asia in places such as Lanka Bible College (Sri Lanka), Myanmar Evangelical Graduate School of Theology, Union Bible Training Center (Mongolia), Jordan Evangelical Theological Seminary, and Biblical Education by Extension training in three restricted access countries.

In 2006 the Griffiths also helped begin Crossroads International Church, Singapore. Here "Dr. Rick" is "Pastor Rick" in his role as pastor-teacher and elder. The church meets at 4 PM on Sundays at the Upper Room of the Metropolitan YMCA at 60 Stevens Road. See [cicfamily.com](http://cicfamily.com) for details.

In 2009 Dr. Griffith began the [biblestudydownloads.com](http://biblestudydownloads.com) website that offers his courses for free download. This includes 5000 pages of course notes in Word and pdf formats, about 400 PowerPoint presentations in English, and hundreds of translations of these by his students into 37 languages. Current languages include Ao, Arabic, Bangla, Bisaya, Burmese, Chin, Chinese, Dutch, English, French, Hindi, Indonesian, Japanese, Kachin, Khmer, Kiswahili, Korean, Lotha, Malay, Malayalam, Mao, Mizo, Mongolian, Nepali, Nias, Paite, Russian, Sinhala, Spanish, Sumi, Tagalog, Tamil, Tangkhul, Tenyidie, Thai, Vaiphei, and Vietnamese.

## Field

Singapore Bible College is strategically located at the "ministry hub" of Southeast Asia, the Republic of Singapore. A small island of only 14 by 26 miles, Singapore is a city-nation located on the tip of the Malayan Peninsula in Southeast Asia. The population of this multi-cultural society is 75 percent Chinese, 15 percent Malay and 8 percent Indian. Other groups include Filipinos, Thais, Japanese, Americans, and Europeans. This beautiful island nation, with dynamic growth in churches and missionary force, has been called the "Antioch of Asia." The Singaporean cross-cultural missionary force is increasingly contributing to God's work in overseas ministries.

## Passion

Rick's passion is for God's leaders to preach and live the Word of God. The servant of God's role is clearly given in the following verses:

- Teaching obedience to Christ's teaching is key to our commission to make disciples (Matt. 28:20)
- The priority of the apostles was teaching and prayer (Acts 6:1-16)
- Paul's legacy to Timothy focused on exposition: "Preach the Word" (2 Tim. 4:2-3)

However, recent trends include the following:

- Church people are biblically illiterate—Amos lamented that his day of prosperity had a "famine for hearing the words of the Lord" (Amos 8:11)
- Pastors are doing too many things so they have too little time to feed the flock
- Preachers give empty and simplistic sermons
- Attempting to be "relevant," pastors preach what people want to hear—not what they need

## Why Study the Old Testament?

Adapted from Elizabeth Achtemeier, *Preaching From the Old Testament*, 21-26

### I. The Problem: Most Christians today don't know the OT

- A. Signs of Ignorance
- B. OT Preaching

### II. Reasons We Must Know Our OT

#### A. God's Nature is Revealed in the OT

- 1. Creator
- 2. Holy & Just
- 3. Personal
- 4. Unknowable (unless He chooses to reveal Himself)
- 5. Sovereign

#### B. Man's Nature is Revealed in the OT

- 1. How do these non-Christian perspectives understand man?
  - a. Evolutionists say we are nothing more than animals.
  - b. New Agers seek to dissolve our individual personalities into a mystical Soul.
  - c. Marxists classify us in terms of economic forces.
  - d. Sociologists
  - e. Governments
  - f. The military
  - g. Doctors
  - h. Advertisers

- 2. Contrast these perspectives with a view of man obtained in the OT.

#### C. The World's Nature is Revealed in the OT

- 1. Evolution has taught us the world is a closed system (no outside influence acts upon it).
- 2. If this is true then there exists no God and no future judgment.
- 3. If this is false then God exists and His promise of an even better world will come true.

#### D. The OT is Foundational to the NT

- 1. **Messianic Prophecies:** We cannot understand how Jesus Christ is the fulfillment until we understand from the OT what prophecies about Him were made (Luke 24:44-45).
- 2. **Covenants:** We won't understand the NT's new covenant until we know the old covenant (cf. p. 22). Unless we comprehend law, we will not appreciate grace.
- 3. **Kingdom Purpose:** We must understand God's original plan for man in Eden (Gen. 1:26-27) before we can see how we participate in this now and in eternity (cf. p. 22).
- 4. **The People of God:** We must know about Israel before we can understand the church (cf. pp. 117-18).

#### E. Most of the Bible is Contained in the OT

- 1. The OT comprises over 2/3 of God's written revelation.
- 2. "In many respects that last third of our canon in the New Testament is simply a final reinterpretation and summing up of the two thirds that have gone before in the Old Testament" (Achtemeier, 23). She overstates her case, but the OT is still important.
- 3. If we believe that "all Scripture is inspired of God and profitable for teaching, reproof, correction, and training in righteousness" (2 Tim. 3:16), then we must preach the OT!



# Old Testament Overview

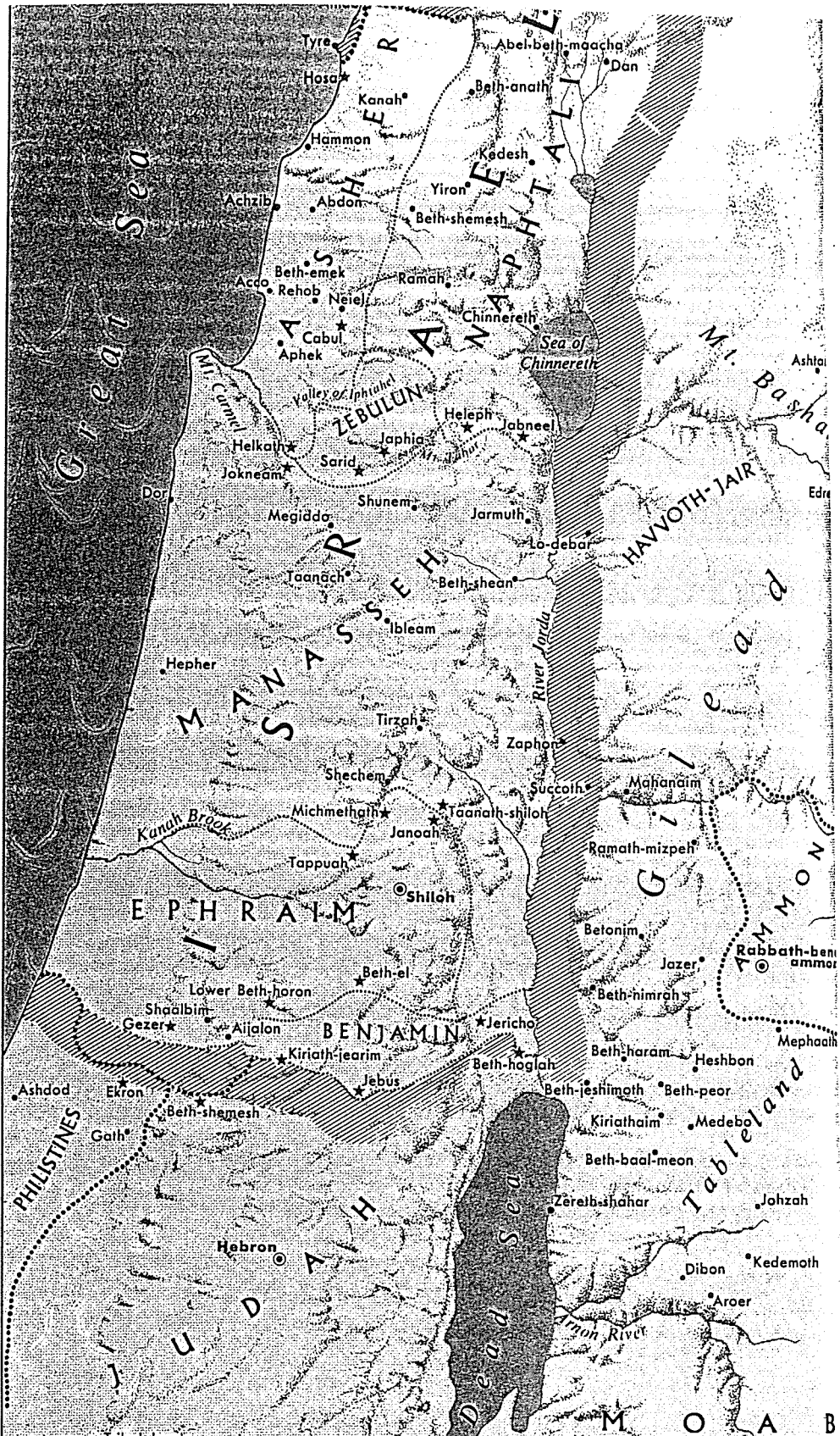

**The Seven Great Periods of History**

Terry Hall, *Bible Panorama*, 157

PERIOD	YEARS	SCRIPTURE
1. NATIONS	2,000 +	GEN. 1—11
2. ISRAEL	2,000	GEN. 12—MAL. 4
3. SILENT YEARS	400	NONE
4. CHRIST ON EARTH	about 33	MATT. 1—ACTS 1
5. CHURCH ON EARTH	? ?	ACTS 2—REV. 3
6. TRIBULATION	7	REV. 4—19
7. CHRIST'S KINGDOM	1,000	REV. 20—22

# Stages of God's Plan in History

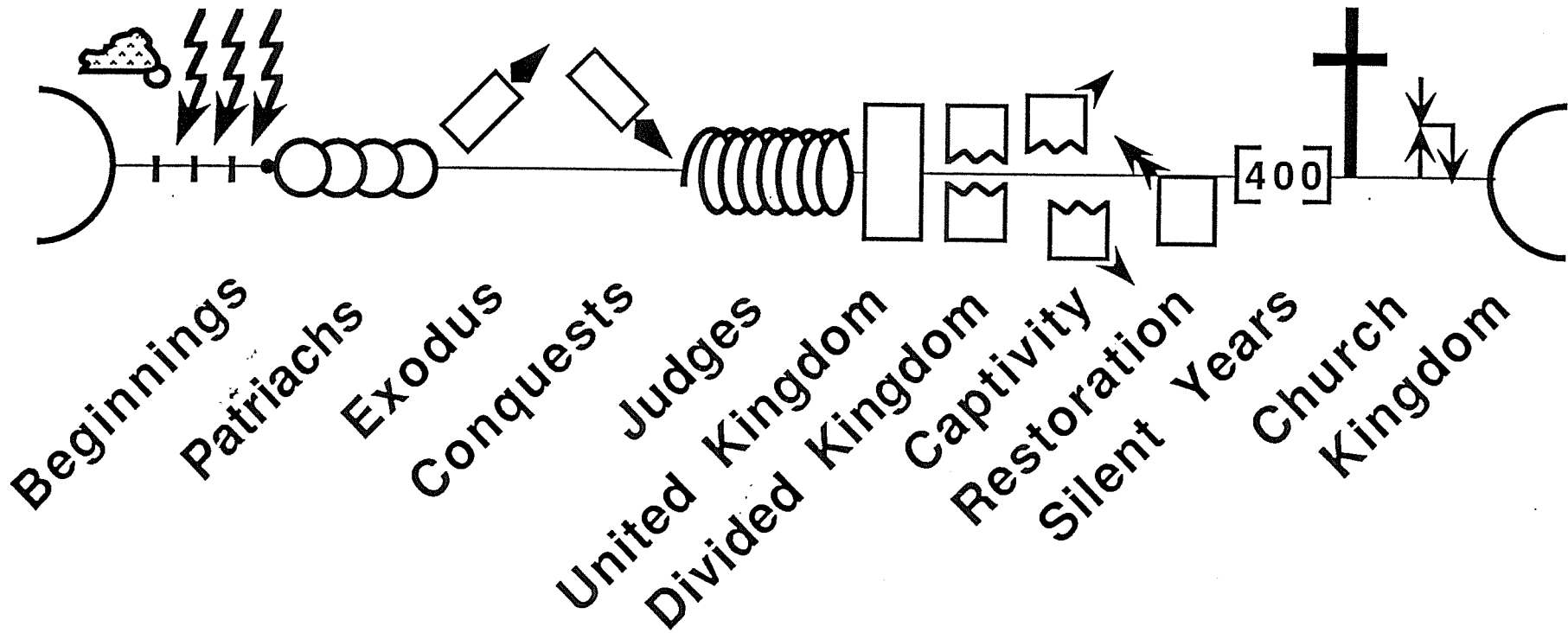

**Stages of God's Plan in History**  
 Dr. Max Anders, Dallas Theological Seminary

Source:  
 Dr. Max Anders  
 Dallas Theological Seminary  
 Course 725, Summer 1984

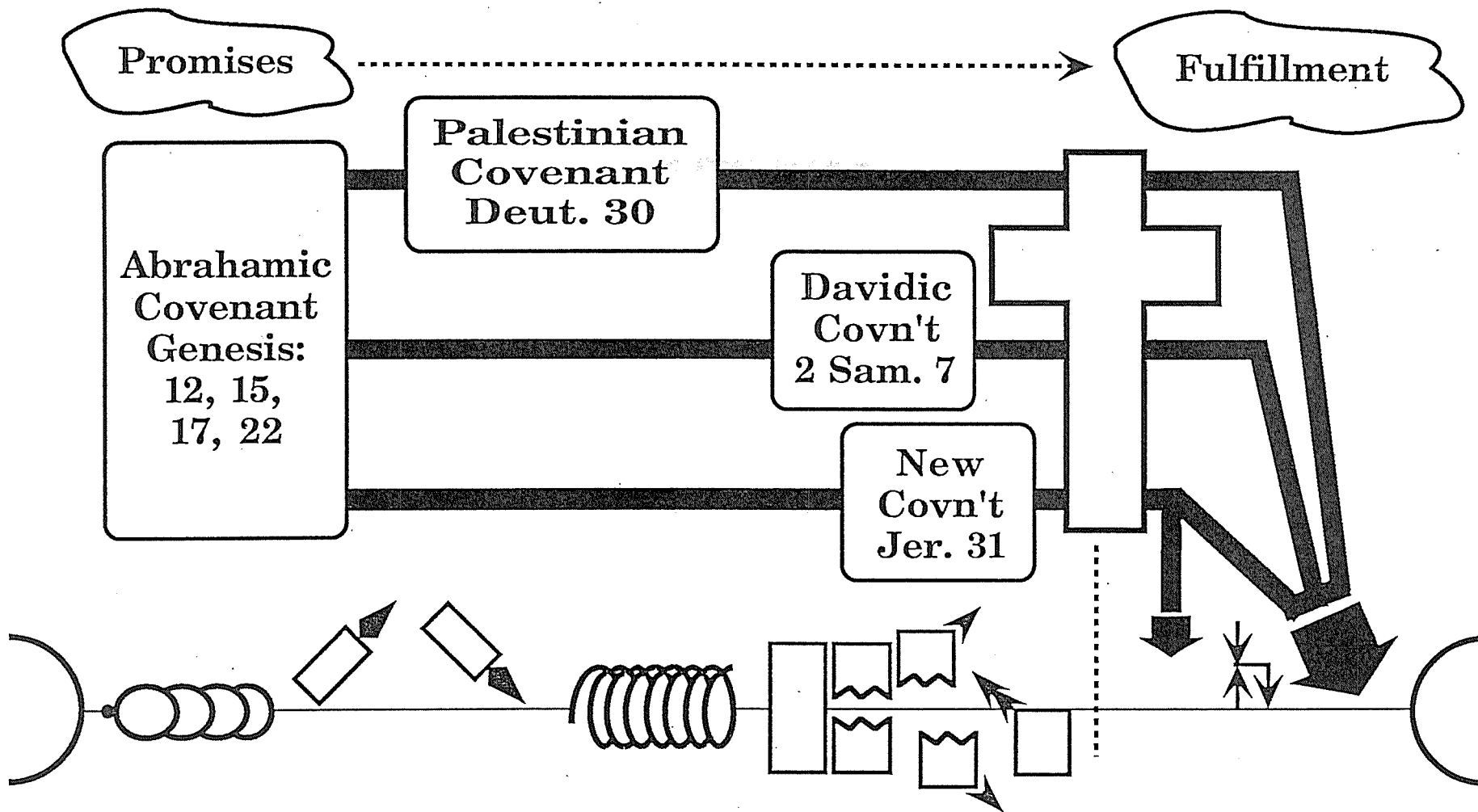

# The Abrahamic Covenant & Its Fulfillment

# Kingdom & Covenants Timeline

22 &  
337

## Kingdom Teaching...



Fall of Man (Gen. 3)

## NOAHIC COVENANT

Genesis 6:18; 9:8-17



ABRAHAMIC COVENANT

Genesis 12:1-3

land

## LAND COVENANT

- Genesis 15:18 (cf. Deut. 30:1-10) promises:
- Land from Wadi of Egypt to Euphrates River (Isa. 27:12)
  - Eternal possession of land (Gen. 17:8) after exile/restoration
  - Whole world blessed via the land (Isa. 14:1-2)

seed

## DAVIDIC COVENANT

- 2 Samuel 7:12-16 promises perpetual:
- Sons ("house" never wiped out)
  - Kingdom (political dynasty)
  - Throne (right to rule by descendants)
  - Temple (son to build it)

blessed

## NEW COVENANT

- Jeremiah 31:31-34 promises:
- Forgiveness
  - Indwelling Spirit
  - New heart, nature, mind
  - Reunification of Israel and Judah
  - No need for evangelism

ISRAEL  
(National Focus)

CHURCH  
The "New Man" (Eph. 2:15)

MESSIANIC  
Millennial

KINGDOM  
Eternal

Israel judged for rejecting Messiah by dispersion away from land for 19 centuries (AD 70-AD 1948) but now partially restored (Ezek. 37:1-7)

Christ is Head over His Church, which is a spiritual temple (Eph. 2:19-22; 2 Cor. 6:16)

Christ reigns over the world (Isa. 11) with saints (Rev. 5:10; 20:4-6)

Christ hands kingdom over to Father (1 Cor. 15:24)

Mosaic Law replaced with first three elements of the New Covenant (Luke 22:26; 2 Cor. 3:8)

All 5 elements fulfilled in national restoration (Zech. 8)

All things made new! (Rev. 21:5)

## MOSAIC COVENANT

Temporary (Gal. 3:19) and conditional (Deut. 28) to reveal sin (Rom. 7:7) and regulate Israel (Gal. 3:23-25)

Law abolished, fulfilled, and replaced at the cross (Rom. 7:1-6; 1 Cor. 9:19-21; Heb. 8:13)

Sixth Edition  
15 June 2012

Scripture has a dual kingdom-covenant emphasis. Israel's role from Abraham to Christ expands to include the Church (continuity) yet the Church never replaces the nation as the "new Israel" (discontinuity). Israel will again enjoy world prominence after trusting in Christ at His second coming.

# The Eschatological Significance of the Sabbath

A visual summary of a ThD dissertation by Richard James Griffith, Dallas Theological Seminary, 1990

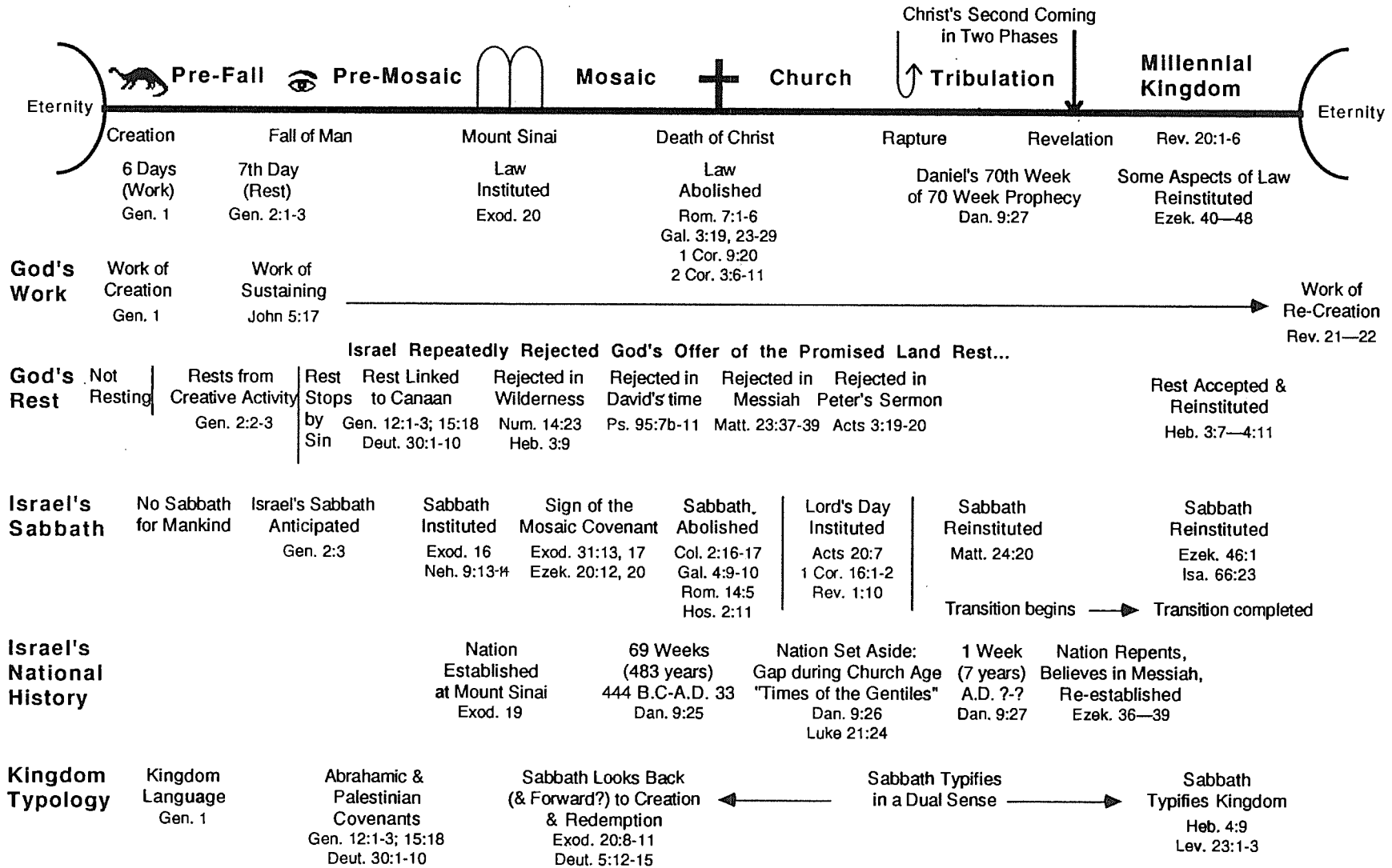

## Government in Scripture

### GOVERNMENT IN SCRIPTURE

*The Bible contains many themes (e.g., redemption, community, promise, covenant, God's glory). However, the most all-encompassing theme is probably the rule of God or kingdom (see the study on pages 32-33). This government has taken many forms in the past but it will culminate in rule under Messiah in the future, which itself will merge into the eternal state.*

<i>Type</i>	Co-Theocracy	Human	Theocracy	Anarchy	Monarchy	Foreign	Monarchy	Co-Theocracy
<i>Rulers</i>	God & Unfallen Man	Man & Satan	God	Judges	Kings of Israel & Judah	Pagan Kings and Heads of State	Messiah with Believing Israel & Gentiles	God & Redeemed
<i>Ruler Names</i>	Lord God Adam Eve	Adam Noah Abraham	God via Moses God via Joshua	Gideon Samson Samuel	Saul David Hoshea Zedekiah	Nebuchadnezzar Cyrus Herod Clinton (!)	Christ	God
<i>Subjects</i>	Animals	All men	Israel	Israel	Israel	Israel & nations	Israel & Gentiles	Angels (?)
<i>Authority</i>	Fellowship with God	Conscience of each individual	Mosaic Covenant (Law)	Each man's opinion	Mosaic Covenant (Law) & King's Law	Gentile ruler's whim	New Covenant under Christ	Fellowship with God
<i>Sin</i>	Absent	Degeneration	Controlled	Increased	Mixed	Mixed	Reduced Greatly	Absent
<i>Time</i>	4143 BC	4143-1445 BC	1445-1390 BC	1390-1043 BC	1043-586 BC	586-Return of Christ	1000 years	Eternal State
<i>Scripture</i>	Gen. 1-2	Gen. 3-Exod. 18	Exod. 19-Josh. 24	Judg. 1-1 Sam. 7	1 Sam. 8-2 Chron. 36	Dan. 9:26; Luke 21:24	Isa. 11; Rev. 20:1-6	Rev. 21-22



# THE BIBLE'S STORY

1	2	3	4	5	6	7	8	9	10	11	12	13	14	15	16	17
Genesis	Exodus	Leviticus	Numbers	Deuteronomy	Joshua	Judges	Ruth	1 Samuel	2 Samuel	1 Kings	2 Kings	1 Chronicles	2 Chronicles	Ezra	Nehemiah	Esther

18	19	20	21	22	
Silent Years	Matthew	Mark	Luke	John	Acts

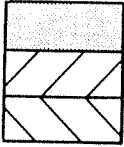
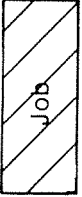

KEY:  
 History  
 Experience  
 Prophecy

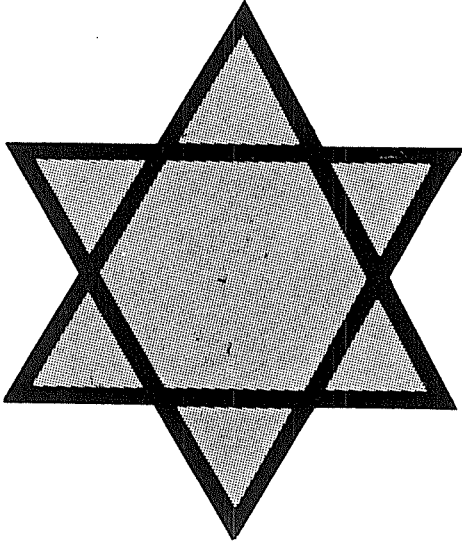

Psalms	Proverbs	Isaiah	Haggai
		Jeremiah	Zechariah
		Lamentations	Malachi
Ecclesiastes		Ezekiel	
Song of Songs		Daniel	
		Hosea	
		Joel	
		Amos	
		Obadiah	
		Jonah	
		Micah	
		Nahum	
		Habakkuk	
		Zephaniah	

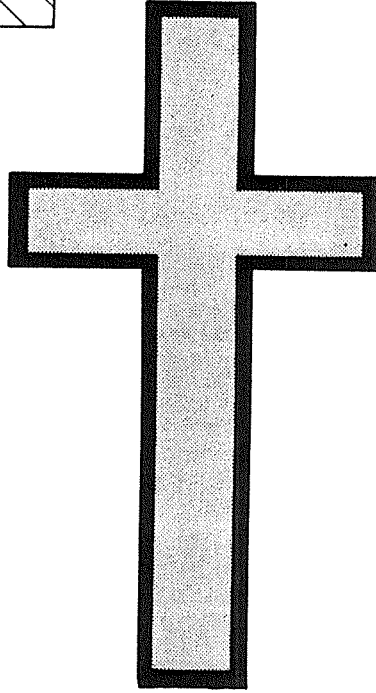

Romans
1 Corinthians
2 Corinthians
Galatians
Ephesians
Philippians
Colossians
1 Thessalonians
2 Thessalonians
1 Timothy
2 Timothy
Titus
Philemon
Hebrews
James
1 Peter
2 Peter
1 John
2 John
3 John
Jude
Revelation

**The Bible's Story**  
 Terry Hall, *Bible Panorama*, 14

# OLD TESTAMENT

## HISTORICAL BOOKS

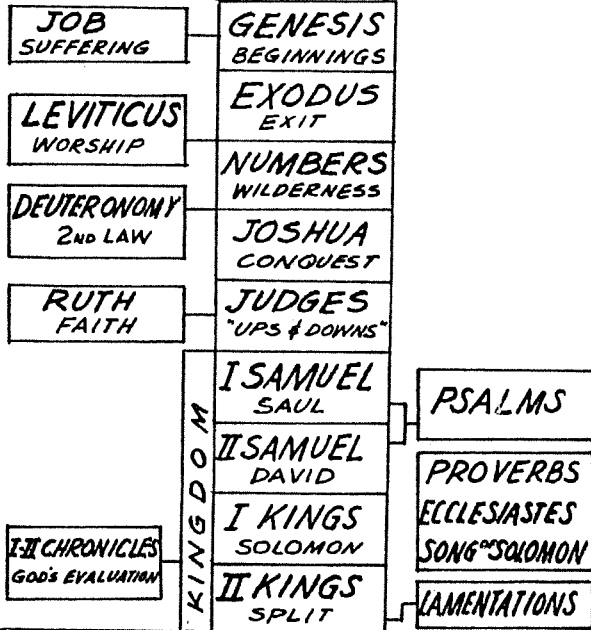

## PROPHETIC BOOKS

TO NINEVAH:  
**JONAH**  
**NAHUM**

TO ISRAEL:  
**AMOS**  
**HOSEA**

TO EDOM:  
**OBADIAH**

TO JUDAH:  
**ISAIAH**  
**MICAH**  
**JOEL**  
**HABAKKUK**  
**ZEPHANIAH**  
**JEREMIAH**

## 70 YEARS OF CAPTIVITY IN BABYLON

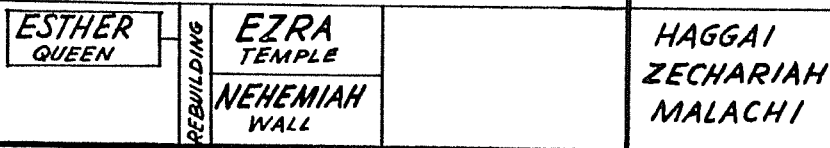

## 400 YEARS OF SILENCE

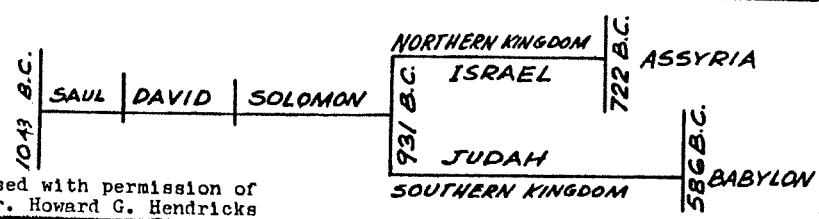

Used with permission of Dr. Howard G. Hendricks

# NEW TESTAMENT

## HISTORICAL BOOKS

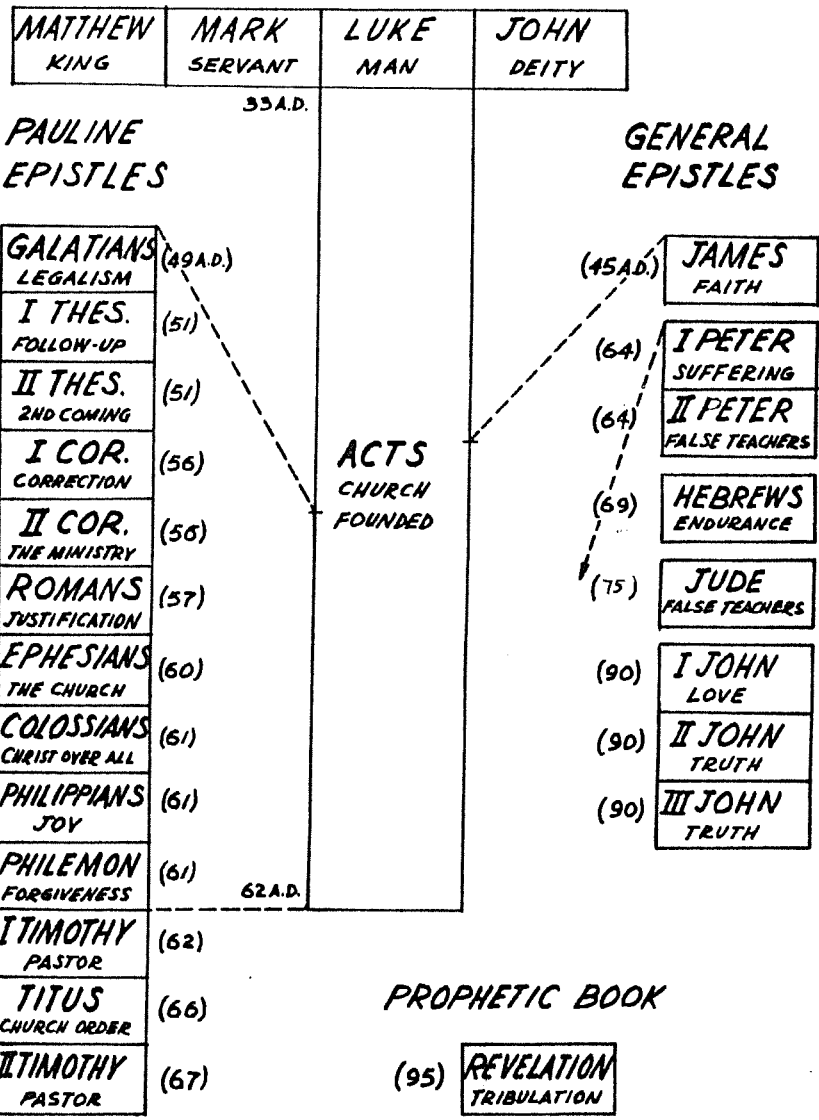

# Overview of the Old and New Testaments

Howard G. Hendricks and Klaus D. Issler, Dallas Theological Seminary, adapted

# Maps of the OT and Modern Mid-East (complete)

Terry Hall, *Bible Panorama*, 49, adapted (top) and Alfred Hoerth et. al., *People of the Old Testament World*, 16, adapted (bottom)

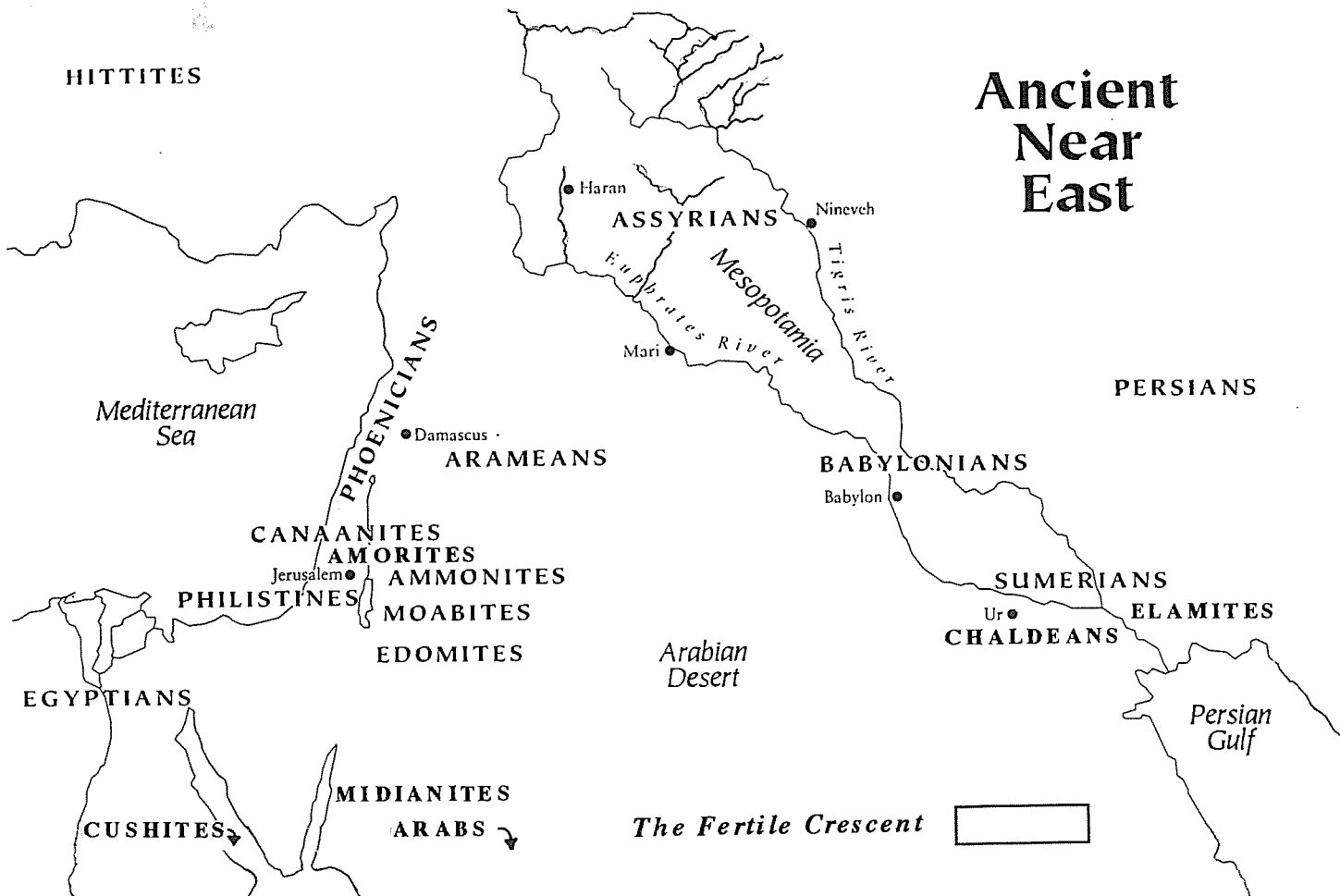
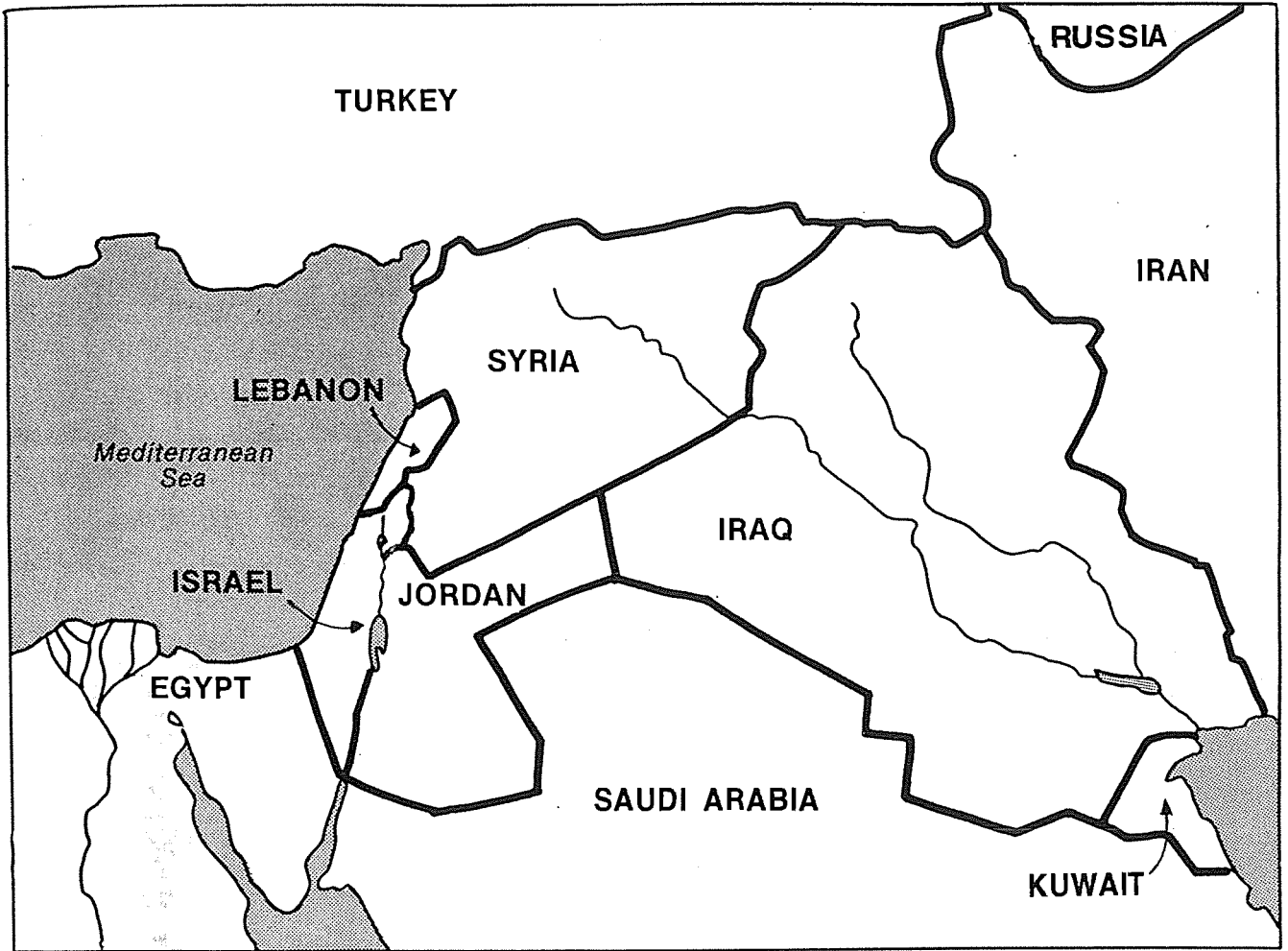

## Map of the OT Mid-East (incomplete)

Terry Hall, *Bible Panorama*, 181

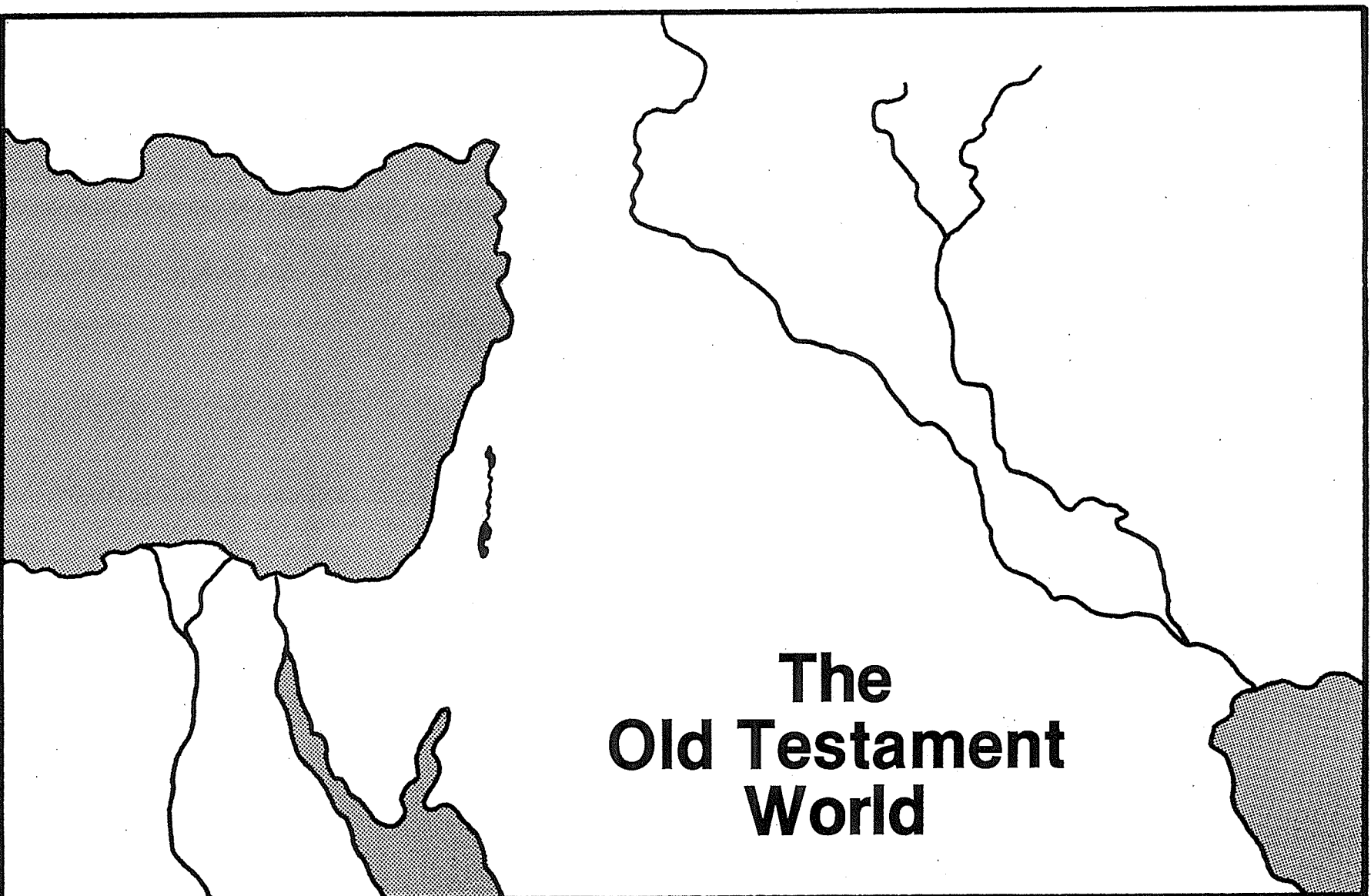

# Sizes of the Mid-East and SE Asia Contrasted

Adapted from Terry Hall, *Bible Panorama*, 44

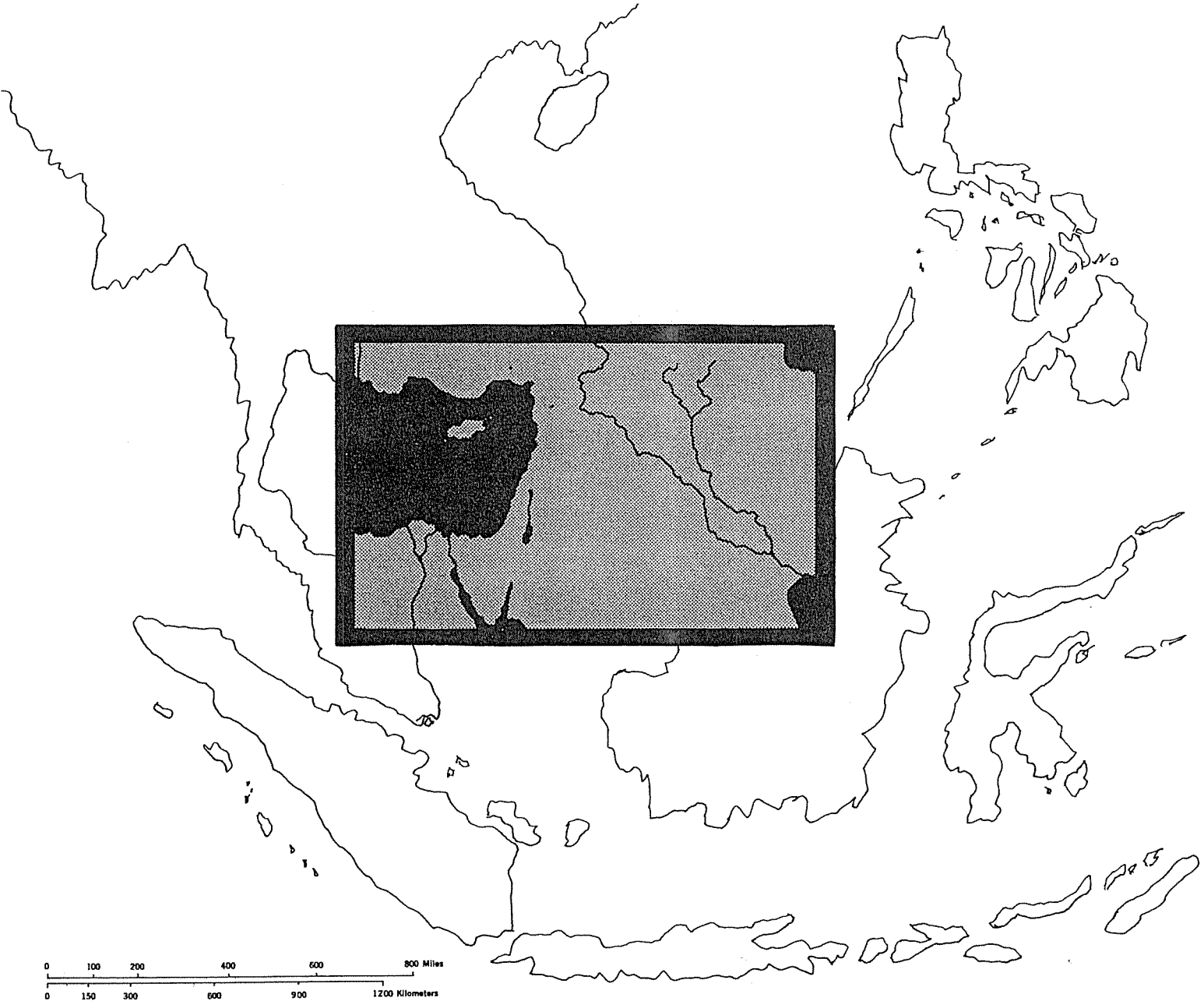

# The Geographical Old Testament

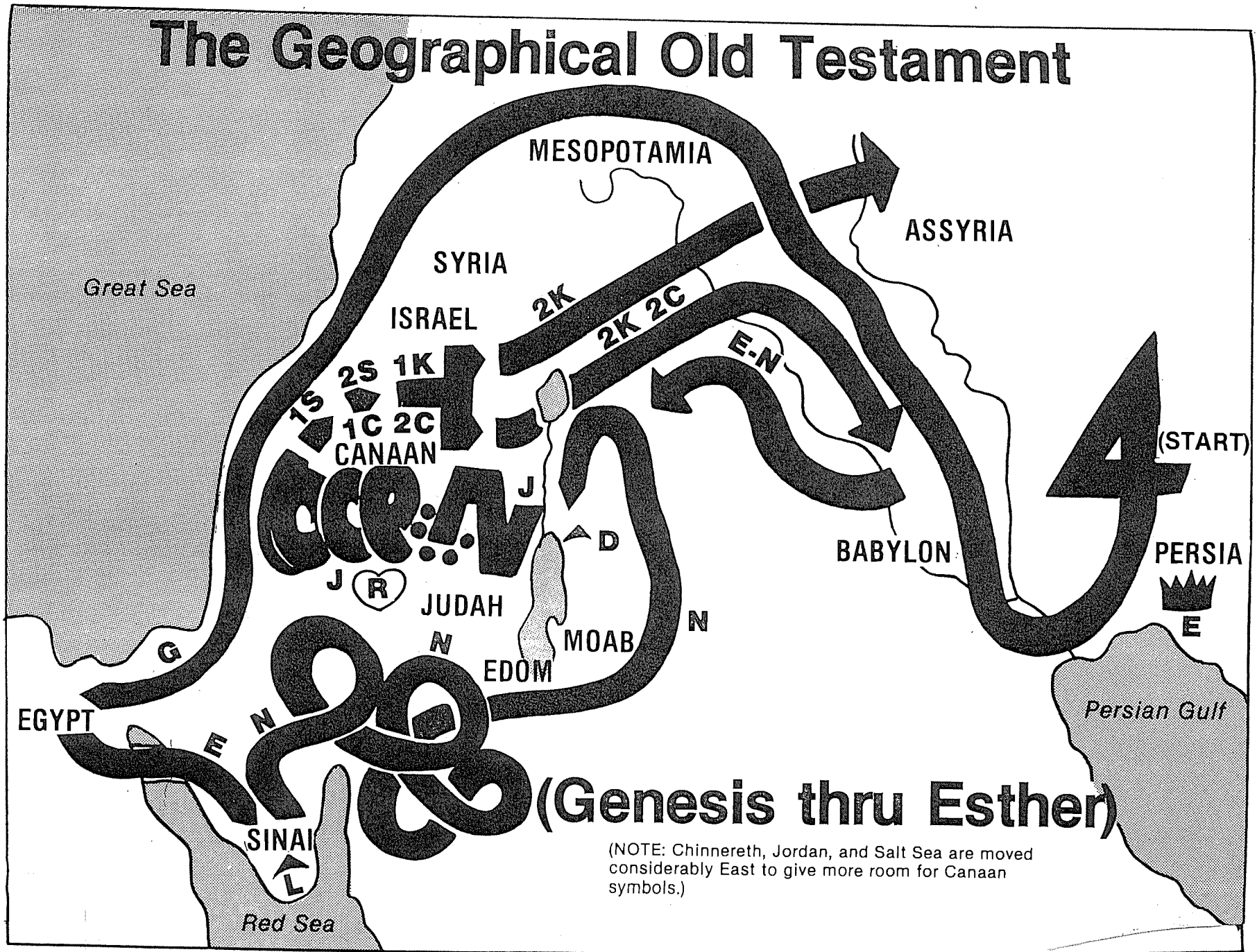

(NOTE: Chinnereth, Jordan, and Salt Sea are moved considerably East to give more room for Canaan symbols.)

# OLD TESTAMENT STORY

**T**he Old Testament is God's story. In its pages we see God at work in the lives of ordinary and extraordinary people. God did not only give a list of rules to obey. He showed what happened when people lived as he wanted, and what happened when they ignored him.

Most of all, we see how God prepared his people for the coming of Jesus. This chart shows some of the important events in the history of God's people, and the order in which they came.

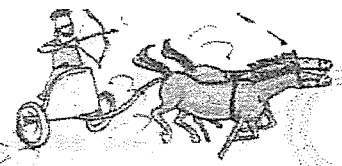

16 Jerusalem, the capital of Judah, is destroyed by Babylon



17 Exile: the Israelite people are taken away as prisoners and spend 70 years in Babylonia

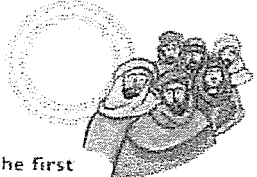

18 The first people return from exile

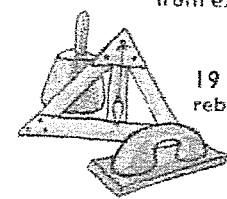

19 Zerubbabel rebuilds the Temple

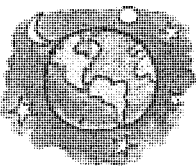

1 Creation



10 Gideon and the other tribal judges rule the people

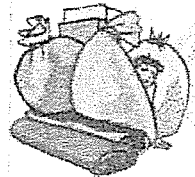

11 Saul, the first king of the Israelites

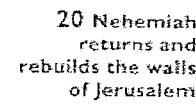

20 Nehemiah returns and rebuilds the walls of Jerusalem

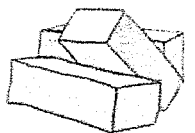

21 Ezra returns and rebuilds religious life



22 The Roman army invades Israel



3 Noah is saved from a great flood



4 Abraham travels to Canaan

12 David, Israel's greatest king

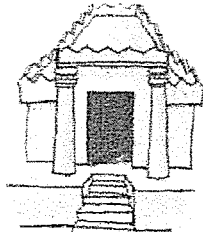

13 Solomon builds the first Temple



23 King Herod is made king

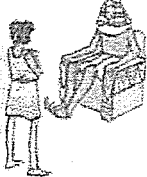

5 Joseph is taken to Egypt

6 Joseph's family follows him

24 Jesus is born

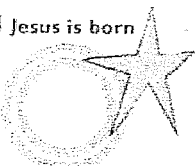

7 The Exodus: Moses rescues the slaves

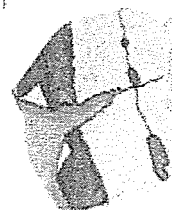

14 The kingdom splits into Israel and Judah

8 Mount Sinai: God gives Moses the Ten Commandments

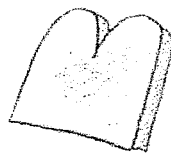

9 Joshua leads the people into Canaan

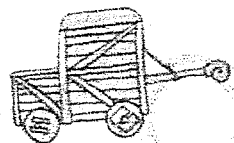

15 Samaria, the capital of Israel, is destroyed by Assyria

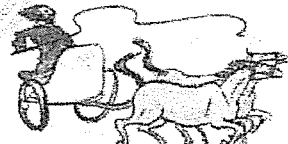

Source: Children's Encyclopedia



## Who Am I?

Source Unknown

The puzzle below was written by a lady in California in 1890, in response to a man who said that he would pay \$1,000 to anyone who would write a puzzle that he could not solve. He failed to do so and paid that lady the \$1,000 which was a great sum at that time!

The answer is ONE WORD, FIVE LETTERS LONG, and appears only 4 times in the King James version of the Bible. An 8 year-old boy later figured it out! Can you?

WHO AM I?

God made Adam out of dust,  
 But thought it best to make me first;  
 So I was made before the man,  
 According to God's holy plan.  
 My whole body God made complete,  
 Without arms or hands or feet.  
 My ways and acts did God control,  
 But in my body He placed no soul.  
 A living being I became  
 And Adam gave to me a name.  
 Then from his presence I withdrew  
 For this man, Adam, I never knew.

All of my Maker's law do I obey,  
 And from these laws I never stray.  
 Thousands of me go in fear,  
 But seldom on earth appear.  
 Later, for a purpose God did see,  
 He placed a living soul in me.  
 But that soul of mine God had to claim  
 And from me took it back again.  
 And when this soul from me had fled,  
 I was the same as when first made;  
 Without arms, legs, feet, or soul,  
 I travel on from pole to pole.

My labors are from day to night,  
 And to men I once furnished light.  
 Thousands of people both young and old  
 Did by my death bright lights behold.  
 No right or wrong can I conceive;  
 The Bible and its teaching I can't believe.  
 The fear of death doesn't trouble me;  
 Pure happiness I will never see.  
 And up to heaven I can never go,  
 Nor in the grave, or hell below.  
 So get your Bible and read with care;  
 You'll find my name recorded there.

## **Hermeneutical Questions of the Old Testament**

1. Why did God choose Israel to be His “kingdom of priests” (Exod. 19:5-6)?
  
  
  
  
  
  
  
  
  
  
2. What role did the Gentiles play after God chose Israel to be His priestly nation?
  
  
  
  
  
  
  
  
  
  
3. What criteria should be used to determine the Bible’s main theme? (For example, should one expect to find the Bible’s theme in every book of the OT and NT? Why or why not?)
  
  
  
  
  
  
  
  
  
  
4. How was salvation attained in the OT? Which Scriptures support your view?
  
  
  
  
  
  
  
  
  
  
5. What role did the covenants play if the Bible’s theme is a kingdom theme?
  
  
  
  
  
  
  
  
  
  
6. Why is it important to distinguish between the Abrahamic and Mosaic covenants?
  
  
  
  
  
  
  
  
  
  
7. Which promises to Israel apply to Gentile believers today? How do you know?

## The Theme of the Old Testament

### I. The Problem

- A. It's helpful to know various facts about the Old Testament such as when the people lived, what they did, lessons we can learn from them, etc.
- B. However, often we can "get lost looking at the trees without ever seeing the forest." So before we discuss this issue as a class let's first get your opinion.
- C. In the next 5 minutes write out what you consider to be the *theme* of the Old Testament in the space below. In other words, what is the OT all about? What is it trying to prove? By all means use your Bible to look up key passages. Try to avoid reading the New Testament into your definition so that it sounds like a NT theme. Make this an OT theme, O.K.?
  1. My View
  2. Other Views in the Class

### II. Solutions (cf. also Gerhard Hasel, *Old Testament Theology*, 3d ed. [Grand Rapids: Eerdmans, 1982], 117-43)

- A. Redemption of Man (Salvation History or Soteriological Purpose)
  1. Proponents: J. Barton Payne, *The Theology of the Older Testament* (Grand Rapids: Zondervan, 1962), 3; Graeme Goldsworthy, *According to Plan* (Leicester, England: IVP, and Homebush West, Australia: Lancer, 1991), 8; Hasel, 141 (but see him under the "God" and "No Center" views below). This is popular at SBC as well.
  2. Statement: The Bible has at its focus the salvation of mankind (as many as will believe) through Jesus Christ. Similar to this theme is viewing the centre of biblical revelation as missiological (e.g., "I do all things for the sake of the gospel" 1 Cor. 9:23; cf. John 4:34).
  3. Critique: Redemption is prominent in the NT but is an external structure imposed on the OT from systematic theology and focuses too much on man rather than God. Also, while Christ is the central person of the Bible, the OT emphasizes Him as King more than as Saviour (there is very little emphasis in the OT on the salvation of individuals). This view also does not include God's program for angels, the unredeemed, and creation as a whole, so it is too restrictive. Finally, it neglects the physical (land) aspects prominent in the OT and is not clearly traced in the wisdom books (not supported in Eccles., Prov., etc.).
- B. Glory of God (Doxological Purpose)
  1. Proponents: Calvinistic (predestination) scholars (cf. Westminster Confession); The holiness of God is a similar theme advocated by E. Sellin, *Theologie des Alte Testamente* (2d ed., Zeipzig, 1936), 19 and J. Hänel, *Die Religion der Heiligkeit* (Glüttersloh, 1931), iii; Paul Lee Tan, *A Pictorial Guide to Bible Prophecy*, 56 (Eschatology notes, 30).
  2. Statement: The Bible has at its focus the glory and worship of God (by as many as God has foreordained). The Westminster Shorter Catechism (1647) states, "Man's chief end is to glorify God and to enjoy him forever" (cf. Rev. 1:6; 4:11; 5:12-13).
  3. Critique: This view is certainly true in that it states the end to which all things point but it is incomplete in that it does not state *how* God seeks to glorify Himself.

## C. Sovereignty of God

1. Proponents: Ludwig Köhler, *OT Theology*, trans. A. S. Todd (Philadelphia, 1957), 30
2. Statement: God is the controller of all events and persons throughout history.
3. Critique: While God does control all things, this view fails to show the end to which God is working in the world.

## D. God

1. Proponents: The later von Rad, *ThLZ* 88 (1963), 406; Hasel, 140 (but see him under the "Redemption" view above and "No Center" view below).
2. Statement: "The OT is in its essence *theocentric* just as the NT is *christocentric*. In short, God is the dynamic center of the OT" (Hasel, 140).
3. Critique: This view is correct in identifying God as the key subject of the Scripture, but it fails in identifying what God seeks to do in the world. Thus it is too general a theme.

## E. Creation Faith

1. Proponents: H. H. Schmidt, 1973 (cited by Hasel, 139)
2. Statement: God is working in the world to create faith in His creatures (?).
3. Critique: More study needs to be done here to determine what Schmidt really means, but at first glance the idea of creation seems too narrow to encompass the whole OT.

## F. Deuteronomistic Theology of History

1. Proponents: S. Hermann (cited by Hasel, 135)
2. Statement: The OT is history written not simply to record facts but to present the theology of the school of scholars who wrote the book of Deuteronomy.
3. Critique: While it is true that OT history is theological in nature, this perspective denies that Moses wrote Deuteronomy and it fails to show how this book alone is broad enough to encompass the whole OT.

## G. Worship

1. Proponents: *Let the Nations Be Glad* (John Piper)
2. Statement: God's purpose is to provide worshippers from every nation (Rev. 5:9; 7:9). This view combines the glory of God and the redemption perspectives.
3. Critique: Revelation 5:9; 7:9 teaches that God will save people from every nation to worship him. However, while this takes place in heaven, these texts are in a Tribulation context. More accurate is Revelation 22:5 because it takes place in the eternal state.

## H. Promise Theme (Blessing or Covenant)

1. Proponents: Walter C. Kaiser, *Toward an Old Testament Theology* (Grand Rapids: Zondervan, 1978), 33 and *Toward an Exegetical Theology: Biblical Exegesis for Preaching and Teaching* (Grand Rapids: Baker, 1981), 139; Walther Eichrodt, *Theology of the Old Testament*, 2 vols., trans. J. A. Baker (Philadelphia: Westminster, 1961); Paul N. Benware, *Survey of the OT* (rev. ed., Chicago: Moody, 1993), 14, 18, 35).
2. Statement: "Such a textually derived center, what the NT eventually was to call the "promise" (*epangelia*), was known in the OT under a constellation of terms. The earliest such expression was 'blessing.' It was God's first gift to the fish, fowl (Gen. 1:22), and then to mankind (v. 28). For men, it involved more than the divine gift of proliferation and 'dominion-having.' The same word also marked the immediacy whereby all the nations of the earth could prosper spiritually through the mediatorship of Abraham and his seed..."

But there were other terms. McCurley counted over thirty examples where the verb *dibber* (usually translated 'to speak') meant 'to promise'" (Kaiser, 33).

3. Key Texts: Gen. 12:1-3 (Abraham); 2 Sam. 7:11-16 (David). Cf. Gen. 3:15; 9:25-27
4. Critique: This is good but it does not take into account Genesis 1—11. For support, Kaiser cites Genesis 1:22, 28 but these verses give commands rather than a promise. The promise theme is, however, very prominent throughout the OT in the progressive establishment of various unconditional covenants by God (see these notes, p. 21).

#### I. No Overall Theme or Center

1. Proponents: The earlier Gerhard von Rad, *Old Testament Theology* (German ed.), 2:376; Gerhard Wright, *Interpreter's One Volume Commentary on the Bible*, 983; Hasel, 123 (but see "Redemption" and "God" views above).
2. Statement: There are many themes in Scripture but no single theme can be said to be the dominant one. "One needs to be on guard that one does not yield to the temptation to make a single concept or a certain formula into an abstract divining-rod with which all OT expressions and testimonies are combined into a unified system" (Hasel, 123). Von Rad notes, "On the basis of the Old Testament itself, it is truly difficult to answer the question of the unity of that Testament, for it has no focal point as is found in the New Testament" (*Die Mitte des AT*, 49).
3. Critique: This theory assumes that because we don't see an overall purpose in the OT, it must not be there. It faults the text rather than our inability to understand. Instead, we should assume that God knows what He is saying but we need to dig deeper to discern it.

#### J. Kingdom Theme (Rule of God)

1. Proponents: Kenneth L. Barker, "The Scope and Center of Old and New Testament Theology and Hope," in *Dispensationalism, Israel and the Church*, eds. Craig A. Blaising and Darrell L. Bock, 305; Eugene H. Merrill, *Kingdom of Priests: A History of Old Testament Israel* (Grand Rapids: Baker, 1987); J. Dwight Pentecost, *Thy Kingdom Come* (Wheaton: SP Pub., 1990), 9; Roy B. Zuck, ed., *A Biblical Theology of the Old Testament* (Chicago: Moody, 1991), ix; Klein, *EvTh* 30 (1970): 642-70; H. Schultz, *OT Theology* (Edinburgh, 1892), 1:56.

Others advocate a modified kingdom theme. Seebass (1965) says the theme is the rule of God; Georg Fohrer, *ThZ* 24 (1965), 161 advocates "the rule of God and the communion between God and man"; and R. Schnackenburg, *NT Theology Today* (New York, 1965) says the key biblical theme is a dual kingdom-covenant idea. I agree with Schnackenburg in this dual kingdom-covenant theme as the central focus of the OT (notes, 22, 24, 33).

2. Statement: "I am in essential agreement with the authors' stated center of biblical theology—basically the kingdom principle of Genesis 1:26-28. Most statements of a theological center are too limited (e.g., promise or covenant), too broad (God), or too man-centered (e.g., redemption or salvation-history). It seems clear that, although there are several great theological themes in Scripture, the central focus of biblical theology is the rule of God, the kingdom of God, or the interlocking concepts of kingdom and covenant (but not covenant alone). This theocratic kingdom is realized and consummated primarily through the mediatorial work of God's (and David's) messianic Son. Significantly, Ephesians 1:9-10 appears to indicate that God's ultimate purpose in creation was to establish His Son—the 'Christ'—as the supreme Ruler of the universe" (Kenneth L. Barker in Zuck, ed., ix).

This is similar to the sovereignty view (see "C" above), yet more complete in that it shows *how* God delegates limited sovereignty/rule to man in the various ages until ultimate sovereignty is given to His Son (Ps. 2).

3. Key Texts: Gen. 1:26-28; 12:1-3; Exod. 19:5-6; Eph. 1:9-10

	Gen. 1:26-28	Gen. 12:1-3	Exod. 19:5-6	Eph. 1:9-10
<b>Event</b>	Creation Mandate	Abrahamic Covenant	Mosaic Covenant	Messianic Kingdom Rule
<b>Mediator or Co-Ruler with God</b>	Man (Adam)	Abraham	Israel	Jesus Christ
<b>Subordinates (what is ruled over)</b>	All creation except people (animals & nature)	All peoples	All peoples	All creation (people, animals & all nature)
<b>Passage</b>	<p>“Then God said, ‘Let us make man in our image, in our likeness, and let them <u>rule</u> over the fish ... birds ... livestock ... all the earth, and over all the creatures that move along the ground...’ God blessed them and said to them, ‘Be fruitful and increase in number; fill the earth and <u>subdue</u> it. <u>Rule</u> over the fish of the sea and the birds of the air and over every living creature that moves on the ground.’”</p>	<p>“...I will make you into a great nation and I will bless you; I will make your name great, and you will be a blessing. I will bless those who bless you, and whoever curses you I will curse; and <u>all peoples on earth will be blessed</u> through you.”</p>	<p>“Now if you obey me fully and keep my covenant, then out of all nations you will be my treasured possession. Although the whole earth is mine, you will be for me a <u>kingdom of priests</u> and a holy nation.”</p>	<p>“And he made known to us the mystery according to his good pleasure, which he purposed in Christ, to be put into effect when the times will have reached their fulfillment –to bring <i>all things</i> in heaven and on earth together under <u>one head</u>, even Christ.”</p> <p>Note that “all things” includes both animals (Isa. 11:6-9) and nature (Matt. 17:27; Mark 4:36-41; 6:45-51; 11:2)</p>

K. Kingdom & Covenants is the best option as it combines “H” and “J” above into one theme...

**My View of the OT’s Theme**

The Old Testament narrates

*God’s restoring man to participate in His kingdom rule for His own glory mandated in Eden but lost in the Fall and accomplished by redeeming man through Israel’s role as a kingdom of priests and ultimately through the Messiah, who will reign as Saviour and King in fulfillment of the Abrahamic Covenant*

# Kingdom, Covenants & Dispensations Diagram

J. Dwight Pentecost, *Thy Kingdom Come* (Wheaton: SP Pub., 1990), 323  
 See my own chart on page 22 as well

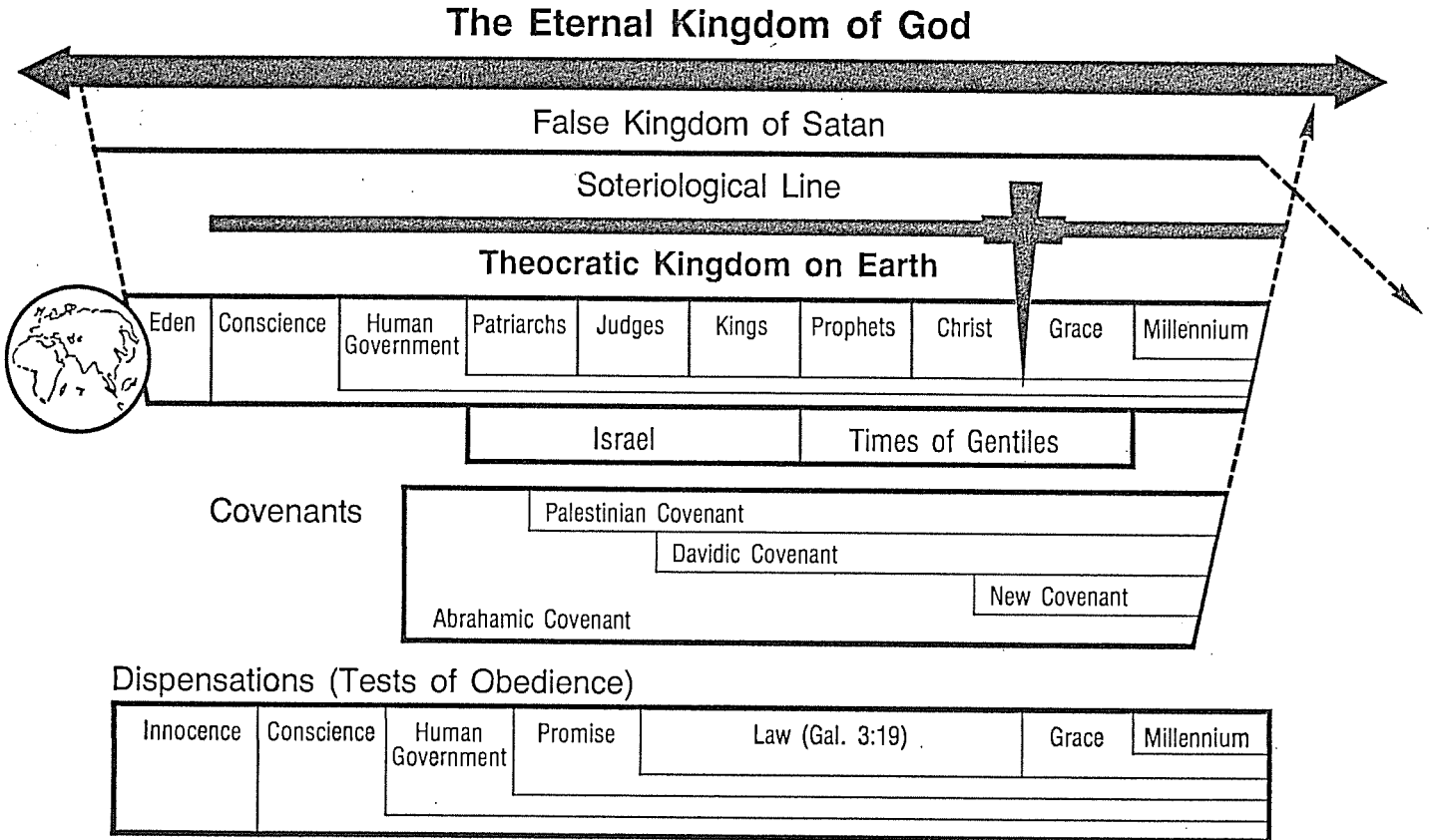



# Introduction to the Old Testament

The Bible has been called “the greatest literary masterpiece ever written by men.” In one book composed of two blending and balancing halves, the Bible traces the plan of God from beginning to end. Beginning with eternity past, the Old Testament tracks God’s history from the creation of the world down through the centuries of time to Malachi in 400 B.C. Beginning after the 400 silent years, the New Testament pursues God’s program from John the Baptist clear into eternity future. The Bible is the ledger of God’s eternal thoughts and intentions reduced to words. In it we see our past, understand our present, and gain hope for our future.

The Old Testament curtain rises on Creation. Though man was created perfect, he spurned God’s will and rebelled. The rest of Scripture records the continuous efforts of God to restore man to his potential, to bring rebellious man back into an Eden-like fellowship with God. His plan involves a chosen man (Abraham), a chosen nation (Israel), and a promised Messiah (Christ).

The Old Testament divides naturally into three parts of 17 books, 5 books, and 17 books.

The Historical Books comprise the first part, the Poetical Books fill the middle section, and the Prophetical Books make up the final division. The following chart portrays the varying emphases and characteristics of these parts of the Old Testament.

<u>Historical Books</u>	<u>Poetical Books</u>	<u>Prophetical Books</u>
Events	Experience	Expectation
Past	Present	Future
God’s Work	God’s Ways	God’s Will
Narrative	Poetry	Prophecy
Covenant People	Covenant Practice	Covenant Preachers

Focusing on events, the Historical Books paint a picture of the birth, growth, development, and discipline of God’s covenant people, Israel. Following a discussion of God’s creation, man’s fall into sin, and God’s universal judgment of sin by the Flood, the camera zooms in on one man, Abraham. Since he is the father of the nation of Israel, much attention is given to him and his descendents. Following their captivity in and release from Egypt, God plants them in the land “flowing with milk and honey.” In an ungrateful response to this shower of blessing Israel runs after other gods, abandoning the God of their fathers Abraham, Isaac and Jacob. This type of behavior dots the landscape of their history through the Judges and Kingdom Periods and on through to the end of the Old Testament.

The Prophetical Books record God’s attempts to call His people back to the covenant behavior they had abandoned. Over and over again God’s faithful prophets rebuked the people for their sin and called them to repentance. And over and over again the people refused to respond. As a result the prophets faced toward the future and predicted God’s coming judgment.

HISTORICAL	POETICAL	PROPHETICAL
Genesis Exodus Leviticus Numbers Deuteronomy	Job Psalms Proverbs Ecclesiastes Song of Solomon	Isaiah Jeremiah Lamentation Ezekiel Daniel
Joshua Judges Ruth 1 Samuel 2 Samuel 1 Kings 2 Kings 1 Chronicles 2 Chronicles		Hosea Joel Amos Obadiah Jonah Micah Nahum Habakkuk Zephaniah
Ezra Nehemiah Esther		Haggai Zechariah Malachi

## Introduction to the Old Testament

Walk Thru the Old Testament

# Structure of the Old Testament

## Structure of the Old Testament

Walk Thru the Old Testament

\_\_\_\_\_ ( )

\_\_\_\_\_ ( )

\_\_\_\_\_ ( )

<p>Genesis Exodus Leviticus Numbers Deuteronomy</p>	<p>Joshua Judges Ruth 1 Samuel 2 Samuel 1 Kings 2 Kings 1 Chronicles 2 Chronicles Ezra Nehemiah Esther</p>
---	--

<p>Job Psalms Proverbs Ecclesiastes Song of Solomon</p>
---

<p>Isaiah Jeremiah Lamentations Ezekiel Daniel</p>	<p>Hosea Joel Amos Obadiah Jonah Micah Nahum Habakkuk Zephaniah Haggai Zechariah Malachi</p>
--	--

Number of books in the O.T.: \_\_\_\_\_

Number of books in the N.T.: \_\_\_\_\_

Number of books in the Bible: \_\_\_\_\_

\_\_\_\_\_  
\_\_\_\_\_  
\_\_\_\_\_

\_\_\_\_\_  
\_\_\_\_\_  
\_\_\_\_\_

\_\_\_\_\_  
\_\_\_\_\_  
\_\_\_\_\_

**Each OT Book in Three Words**  
*Terry Hall, Bible Panorama*

# Each O.T. Book in Three Words

Genesis—Generations to Joseph
Exodus—Exit from Egypt
Leviticus—Levites and Sacrifices
Numbers—Numbering the Hebrews
Deuteronomy—Duplicate of Law

Job—Jehovah and Suffering
Psalms—Praises and Petitions
Proverbs—Prudence in Life
Ecclesiastes—Emptiness in Life
Song of Solomon—Sex in Marriage

Isaiah—Israel's Suffering, Glory
Jeremiah—Judah's Exile, Return
Lamentations—Lament over Jerusalem
Ezekiel—Expectations for Temple
Daniel—Days of Gentiles

Joshua—Judgment on Canaan
Judges—Jewish Sin Cycles
Ruth—Romance of Redemption
1 Samuel—Samuel and Saul
2 Samuel—Summary of David
1 Kings—Kingdom Is Divided
2 Kings—Kingdoms Taken Captive
1 Chronicles—Commentary on Samuel
2 Chronicles—Commentary on Kings



Hosea—Heart of Holiness
Joel—Judah's Judgment Day
Amos—Attitudes toward Law
Obadiah—Obliteration of Edom
Jonah—Judgment Spared Nineveh
Micah—Morality in Society
Nahum—Nineveh's Soon Judgment
Habakkuk—Humanity and Sovereignty
Zephaniah—Zion's Remnant Saved

Haggai—House of God
Zechariah—Zion's Remnant Saved
Malachi—Messenger before Messiah

Ezra—Erection of Temple
Nehemiah—New City Walls
Esther—Escape of Jews

Book Chapters	Approximate Chronology of the Contents of Each book		Approximate Time Covered	Major Author/Editor	Approximate Place Written	Approximate Time Written
<b>Genesis</b> 50 chapters	Undated Past (1:1) Creation/Garden of Eden 2165 (12:4) Birth of Abraham/Ur	2165 (12:4) Birth of Abraham/Ur of Chaldees 1805 (50:26) Death of Joseph/Land of Egypt	Genesis 1-11 3000 + years Genesis 12-50 361 years	Moses	Wilderness	c 1445-1425
<b>Exodus</b> 40 chapters	1804 (1:6) Death of Joseph Land of Egypt	April 1, 1444 (40:1) Completion of Tabernacle Encampment at Mt. Sinai	c 360 yrs	Moses	Sinai	c 1444-1425
<b>Leviticus</b> 27 chapters	April 1, 1444 (Ex 40:17) Completion of Tabernacle Encampment at Mt. Sinai	May 1, 1444 (Num 1:1) First Census taken Encampment at Mt. Sinai	c 30 days	Moses	Sinai	c 1444-1425
<b>Numbers</b> 36 chapters	May 1, 1444 (1:1) First Census taken Encampment at Mt. Sinai	February 1, 1405 (Deut 1:3) Preparations to enter Israel Plains of Moab by the Jordan	c 38 yrs. 9 mo.	Moses	Plains of Moab	c 1405
<b>Deuteronomy</b> 34 chapters	February 1, 1405 (1:3) Last words of Moses Plains of Moab	March 1405 (34:8) Death of Moses Plains of Moab	c 30 days	Moses	Plains of Moab	c 1405
<b>Joshua</b> 24 chapters	March 1405 (1:1) After the Death of Moses	c 1383 (24:31) Elders who outlived Joshua	c 22 years	Joshua	Israel: Ephraim	c 1380
<b>Judges</b> 21 chapters	c 1390 (2:8) Death of Joshua	c 1051 (16:30) Death of Samson	c 339 years	Samuel	Israel: Ephraim	c 1025-1011
<b>Ruth</b> 4 chapters	c 1150? (1:1) In the days of the Judges	c 1020? (4:22) After birth of David	c 130 years	Samuel	Israel: Ephraim	c 1020-1011
<b>I Samuel</b> 31 chapters	c 1105? (1:20) Birth of Samuel	1011 (31:6) Death of Saul	c 94 years	Samuel & Nathan	Israel: Ephraim & Jerusalem	c 1025-1010
<b>II Samuel</b> 24 chapters	1010 (1:1) After Death of Saul	c 972 (23:1) Last days of David	c 38 years	Nathan & Gad	Israel: Jerusalem	c 970
<b>I Kings</b> 22 chapters	c 972 (1:1) Last days of David	c 853/848 (22:37, 50) Death of Jehoshaphat & Ahab	c 125 years	Jeremiah	Israel: Jerusalem Egypt: Tahpanhes	c 600-560
<b>II Kings</b> 25 chapters	c 853/52 (1:1-2) After Death of Ahab	April 2, 561 (25:27) Liberation of Jehoiachin	c 292 years	Jeremiah	Israel: Jerusalem Egypt: Tahpanhes	c 600-560
<b>I Chronicles</b> 29 chapters	1011 (10:4) Death of Saul (1:1) begins with Adam in undated past	971 (29:28) Death of David	c 40 + years	Ezra	Babylonia/Persia	c 450-400
<b>II Chronicles</b> 36 chapters	971/90 (1:1) Beginning of Solomon's reign	538 (36:22) Decree of Cyrus to return	c 432 years	Ezra	Babylonia/Persia	c 450-400
<b>Ezra</b> 10 chapters	538 (1:1) Decree of Cyrus to return	458/57 (7:7-9) Return of Ezra to Jerusalem	c 81 years	Ezra	Babylonia/Persia	c 450-400
<b>Nehemiah</b> 13 chapters	445 (1:1; 2:1-8) Decree of Artaxerxes	c 420 (13:6ff) Second Return of Nehemiah	c 25 years	Nehemiah & Ezra	Babylonia/Persia	c 430-400
<b>Esther</b> 9 chapters	484/83 (1:3) Feast of Ahasuerus	475/74 (3:7) Haman's Plot	c 10/11 years	Mordecai?	Persia: Shushan	c 470-450

## Key Words & Kingdom Statements for the OT

*The Bible's key theme is the kingdom of God (cf. pp. 22, 24, 30-33). God's sovereign rule delegated to man is seen in each OT book (to varying degrees). Sometimes the following message statements match those of the book studies in these notes (e.g., pp. 41-42), but in most cases the statements are adapted to show their book's kingdom emphases.*

<u>Book</u>	<u>Key Word</u>	<u>Kingdom Message Statement</u>
Genesis	<i>Election</i>	God created a perfect kingdom (1-2), but man gave his rule to Satan (3), so God <u>elect</u> ed a seed to produce a Ruler (4-11) to bless all nations in Abraham (12-50).
Exodus	<i>Formation</i>	God, as Sovereign King, began <u>form</u> ing Israel as a theocratic nation by redeeming (1-18) and instructing (19-40) the nation how to be a kingdom of priests (19:5-6).
Leviticus	<i>Sanctification</i>	God would remain theocratic King (cf. Exod. 39:34) only as Israel <u>sanctified</u> herself before Him through sacrifice (1-10) and separation from paganism (11-27).
Numbers	<i>Preparation</i>	God <u>pre</u> pared Israel to possess Canaan as her kingdom (1:1-10:10) and postponed it due to her unbelief (10:11-25:18), then poised a believing generation (26-36).
Deuteronomy	<i>Renewal</i>	Moses exhorted Israel to <u>renew</u> obedience to the Sinai Covenant so as to function as God's kingdom representatives in Canaan for blessing to the whole world.
Joshua	<i>Occupation</i>	God provided the land of Canaan which Israel subdued (1-12) and <u>occup</u> ied (13-24) to be God's priests and co-sovereigns to rule over the other nations.
Judges	<i>Failure</i>	Israel <u>fail</u> ed to implement God's direct rule over the nation, showing the need for a righteous king to lead the nation under a monarchy (21:25).
Ruth	<i>Rewards</i>	Ruth and Boaz were <u>re</u> warded for submitting to God's rule over their individual lives despite the fact that this was not true of the nation as a whole.
1 Samuel	<i>Transition</i>	The <u>tran</u> sition from a degenerate theocracy under Eli and Samuel (1-7) to a monarchy under Saul and David (8-31) shows how God's sovereignty was delegated to the divinely elected Davidic kings who were to rule justly.
2 Samuel	<i>Covenant</i>	God delegated His rule to David and his seed by <u>cove</u> nant (1-10) and protected his dynasty despite punishing David's sin and the rivals to the throne (11-24).
1 Kings	<i>Division</i>	Solomon relinquished his right to rule over a united kingdom by his disobedience (1-11), yet even after the nation <u>div</u> ided God stayed loyal by providing kings in his dynasty so that One may once again rule a united kingdom (12-22).
2 Kings	<i>Downfalls</i>	Continued rejection to rule under God as a monarchy <u>de</u> stroyed both Israel (1-17) and Judah (18-25), yet the Davidic line remained intact.
1 Chronicles	<i>Establishment</i>	God's sovereign <u>estab</u> lishment of David's line (1-9) and David's concern for proper temple worship (10-29) reminded Israel not to repeat the idolatry of the past.
2 Chronicles	<i>Preservation</i>	Rejecting to rule under God ended the rule of Solomon (1-9) and Judah's kings (10-36) yet God <u>pre</u> served David's line to exhort Israel to proper temple worship.
Ezra	<i>Temple</i>	God began restoring his rule via Zerubbabel (temple: 1-6) and Ezra (people: 7-10).
Nehemiah	<i>Walls</i>	God restored Jerusalem's <u>w</u> alls (1-7) yet an incomplete restoration of the people (8-13) prevented His rule from extending forth from Zion.
Esther	<i>Providence</i>	God's <u>pro</u> vidence in averting Israel's destruction showed His rule over all nations.

Job	<i>Incomprehensibility</i>	God must have sovereign rule over man because of man's <u>inability</u> to understand the cause for suffering and other aspects of creation (38-42).
Psalms	<i>Praise</i>	<u>Praise</u> and petition to God is the right response of worshipping the Divine King.
Proverbs	<i>Wisdom</i>	Submission to God's rule is the foundation of living with <u>wisdom</u> (1:7).
Ecclesiastes	<i>Meaningless</i>	Life is <u>meaningless</u> without submission to God's rule (12:8, 13).
Song of Sol.	<i>Love</i>	Submission to God's rule produces the highest degree of marital <u>love</u> possible.
Isaiah	<i>Restoration</i>	After the Jews are judged and believe in the Messianic King (1-39), God will <u>restore</u> the whole created order under the rule of His Son (40-66).
Jeremiah	<i>Inevitable</i>	The judgment of Jerusalem was <u>inevitable</u> due to her refusal to obey the old covenant (1-19), yet after a 70-year captivity (25:11-12) and judgment on the Gentiles, Israel will submit to God's rule under a new covenant (30-33).
Lamentations	<i>Confession</i>	Jeremiah tells of the siege and reasons for Jerusalem's fall (1-4) as a model of <u>confession</u> for the nation to be restored under God's rule (5).
Ezekiel	<i>Glory</i>	God sovereignly judged Judah (1-24) and the nations (25-32), yet will restore His <u>glory</u> through a return to the land with a new temple and worship system (33-48).
Daniel	<i>Sovereignty</i>	God's <u>sovereignty</u> remains steadfast despite the rise and fall of many nations until the establishment of kingdom blessing under His Messianic Ruler (9:24-27).
Hosea	<i>Loyal</i>	Despite God's discipline of Israel for rejecting Him, God remains <u>loyal</u> to the nation as a motivation for the nation to submit to His rule as a loving Husband.
Joel	<i>Locusts</i>	God disciplined Israel via <u>locusts</u> (1) and will do so again via other means (2:1-17) but ultimately He will restore the nation's rule after repentance (2:18-3:21).
Amos	<i>Injustice</i>	Social <u>injustice</u> should not occur in God's elect nation appointed to rule the world, so it will be disciplined (1:1-9:7) and restored under a Davidic king (9:8-15).
Obadiah	<i>Edom</i>	As universal King, God will judge <u>Edom</u> and all nations who oppose His nation.
Jonah	<i>Compassion</i>	God is shown as a <u>compassionate</u> King in Jonah's failure to serve as His divine representative to Nineveh (4:10-11), noting Israel's same sin towards all Gentiles.
Micah	<i>Exploitation</i>	God will judge His people for <u>exploiting</u> their poor but after their repentance He will bless them in the messianic kingdom (2:12-13; 4:1-5:15; 7:7-20).
Nahum	<i>Nineveh</i>	God's judgment of <u>Nineveh</u> will demonstrate his rule over all nations (1:3).
Habakkuk	<i>Faith</i>	God's people must have <u>faith</u> in His sovereignty (2:4) which may include raising up instruments of His justice that are even more wicked than His people (1:12f.).
Zephaniah	<i>Day</i>	Judah should repent because of a future <u>day</u> of judgment (1:1-3:8) and blessing (3:9-20) on the whole earth caused by God as King.
Haggai	<i>Priorities</i>	Judah must get right <u>priorities</u> (1:9) for blessing in the Messiah's kingdom.
Zechariah	<i>Messiah</i>	Judah must rebuild the temple (6:9-15) for blessing in the <u>Messiah's</u> kingdom.
Malachi	<i>Hypocrites</i>	Judah must repent of <u>hypocrisy</u> (1-3) for blessing in the messianic kingdom (4).

## Message Statements for OT Historical Books

The following is a summary of the message of each Old Testament historical book in order. Many commentaries on the Bible provide only the themes of the biblical books. That is, they provide only the *subject* of that book, or *what* the book says. This list seeks to go a step further in stating the *purpose*, or *why* the subject is addressed to the readers in the first place. For example, it is incomplete to simply say that Moses wrote Genesis to record the history from creation to Joseph (the subject). The purpose answers *why* he wanted to share this: because the nation needed to see how it was unconditionally elected by God and thus unique from the other heathen nations. Thus each of the following subject/purpose statements show the fuller message of each book in this twofold way:

<b>Subject</b>	+	<b>Purpose</b>	=	<b>Message</b>
<i>What the book says</i>		<i>Why it says it</i>		<i>Main (Big) Idea</i>
<i>(Theme)</i>		<i>(Reason)</i>		<i>(Summary Statement)</i>

By adding the subject and purpose together in a summary statement for each book it is hoped that the reader will gain a deeper grasp on the book by learning not simply its content but the reason it *was* relevant to its original audience and *is* relevant for us as believers today.

### Genesis

The narrow lineage of Israel from Creation to Joseph informs Israel it began by God's election for rule and unconditional promise for blessings through Abraham in contrast to the Canaanites.

### Exodus

Israel's formation as a nation begins under God as King by a miraculous redemption from Egypt and revelation of the Mosaic Law to provide a kingdom over which a descendant of Judah could rule and to promote holiness and trust in God.

### Leviticus

Leviticus teaches sanctification through sacrifice and separation that Israel might obey the laws demanded by God for His presence to remain with the nation.

### Numbers

God's faithful preparation of His people to enter Canaan contrasts with Israel's unbelieving rebelliousness in the wilderness to teach the nation His unconditional commitment to fulfill His Abrahamic Covenant but only through a believing generation.

### Deuteronomy

Moses preaches and records sermons which expound the Law in order to encourage Israel's new generation in renewal of the covenant at Sinai, resulting in blessing in Canaan for obedience, not cursing for disobedience.

### Joshua

Joshua records Israel's occupation of most of Canaan in fulfillment of God's faithfulness to His promise through Joshua's faith in order to instruct the nation that obedient faith based upon God's promises brings blessing.

### Judges

Israel's failure under the theocracy due to faithless disobedience is contrasted with God's merciful care in disciplining and delivering Israel through judges to exhort submission to its new, divinely appointed kings in a righteous monarchy.



### Ruth

Ruth's devotion to Naomi benefits both of them by God's provision of food, a home, and participation in the Davidic and messianic line to demonstrate how God blesses those who help others.

### 1 Samuel

The transition from a degenerate theocracy under Eli and Samuel to a monarchy under Saul and David is recorded to show how God's sovereignty is delegated to the divinely elected Davidic kings who were to rule justly.

### 2 Samuel

God establishes David as king and protects his dynasty despite punishing David's sin and the rivals to the throne to show His justice and faithfulness to fulfill His purposes through His covenant kindness shown to David and his seed.

### 1 Kings

Solomon's prosperity from loyalty to the Law ends in disobedience which causes the division of the kingdom with mostly evil kings in Israel and Judah to remind Judah of God's loyalty to the Davidic Covenant and its own need to obey the Law.

### 2 Kings

The covenant disobedience and resultant downfalls of the kingdoms of Israel and Judah are contrasted with God's loyalty to the Davidic Covenant to remind Israel of the need to obey the Law—not repeat past mistakes.

### 1 Chronicles

The spiritual perspective on the kingdom period in David's life is given to encourage the remnant with God's sovereign establishment of the Davidic line and to admonish proper temple worship—not the idolatry of the past.

### 2 Chronicles

The spiritual perspective on the kingdom period from Solomon to the return from Babylon is given to encourage the remnant with God's sovereign preservation of the Davidic line and to admonish proper temple worship—not the idolatry of the past.

### Ezra

The restorations of the temple and people to the land under Zerubbabel and Ezra record God's faithfulness and mercy in fulfilling His promise of restoration to encourage the remnant in true temple worship and covenant obedience.

### Nehemiah

The restorations of the walls and people in the land under Nehemiah record God's faithfulness to His promise of restoration to encourage the remnant in covenant obedience rooted in temple worship at Jerusalem.

### Esther

An extermination of the Jewish nation plotted by Haman reverts upon his own head through God's providence through Mordecai and Esther to encourage postexilic Israel of God's continued commitment to the Abrahamic Covenant.

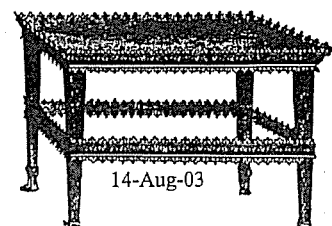
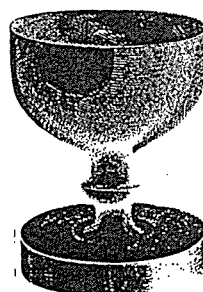

## Pentateuch & Historical Book Themes

SEVERAL THEMES CAN BE TRACED THROUGH THE BOOKS OF THE OT BUT THESE FOUR ARE MOST IMPORTANT:

	KINGDOM	COVENANT	REDEMPTION	MESSIANIC
<b>GENESIS</b>	<p>God created a perfect kingdom (1-2), but man gave his rule to Satan (3), so God <u>elect</u>ed a seed to produce His rightful Ruler (4-11) to bless all nations through Abraham (12-50) and the line of Judah (49:10).</p>	<p>God narrowed man's line from Adam through Seth to Abram (1-11) to establish the Abrahamic Covenant with its unconditional promises of Canaan, eternal rule, and blessing to his descendants (12-50).</p>	<p>Redemption is needed due to man's sin (3:1-7), but as God redeemed Adam and Eve with a sacrificial animal (3:21), so a Redeemer from Eve will finally defeat Satan (3:15), typified in Joseph (45:7).</p>	<p>Jesus created the earth (1:26) and will defeat Satan (3:15), after descending from the line of Abraham (12:1-3) so that he might rule in the line of Judah (49:10).</p>
<b>EXODUS</b>	<p>God, as Sovereign King, began <u>form</u>ing Israel as a theocratic nation by redeeming (1-18) and instructing the nation how to be a kingdom of priests (19-40; esp. 19:5).</p>	<p>As benevolent Initiator of the Abrahamic Covenant, God rescued Israel (1-18) and gave the Mosaic Covenant to help the people know how to obtain the blessings of the Abrahamic Covenant (19-40).</p>	<p>Israel's redemption from Egypt (1-18) typifies the believer's redemption in Christ (1 Cor. 5:7), while the building of the tabernacle (19-40) parallels the redemptive work of Christ (Heb. 9).</p>	<p>As prophet, priest, and theocratic ruler who delivered Israel from Egypt (1-18), Moses typifies Christ as the anointed prophet, priest, ruler, and Saviour as the Passover Lamb (12:13)</p>
<b>LEVITICUS</b>	<p>God would remain theocratic King (cf. Exod. 39:34) only as Israel <u>sanctif</u>ied herself before Him through sacrifice (1-10) and separation from paganism (11-27).</p>	<p>The Mosaic Covenant to which Israel promised faithfulness (cf. Exod. 33-34) can be followed only through sacrifice (1-10) and separation from non-covenant peoples and practices (11-27).</p>	<p>Israel's offering of unblemished animal sacrifices (1-10) and the nation's purity from sin (11-27) parallel Christ's redemption as a spotless Lamb on the ultimate Day of Atonement (ch. 16; cf. Heb. 10).</p>	<p>Israel's sacrifices, offerings, and high priest Aaron (1-10), as well as national purity from sin (11-27) all foreshadow Christ as sinless Redeemer and mediatorial High Priest (Heb. 7).</p>
<b>NUMBERS</b>	<p>God <u>pre</u>pared Israel to possess Canaan as its kingdom (1:1-10:10), postponed this due to the nation's unbelief (10:11-25:18), yet finally poised the believing generation to rule a new land in the end (26-36).</p>	<p>God's showed Israel how to be blessed due to the Abrahamic Covenant (1:1-10:10) but also noted that covenant blessing comes by faith (10:11-25:18), claimed only by the new generation (26-36).</p>	<p>The pilgrimage of the redeemed Israelites towards Canaan typifies the redeemed believer today in his journey to heaven (1 Cor. 10:1-13; Heb. 13:13).</p>	<p>As Moses led Israel to Canaan by faith in the God of the bronze serpent (21:4-9), so Christ leads the believer today towards heaven by his faith in Christ's death on the cross (John 3:14).</p>

	KINGDOM	COVENANT	REDEMPTION	MESSIANIC
DEUTERONOMY	Moses exhorted Israel to <u>renew</u> obedience to the Sinai Covenant so as to function as God's kingdom representatives in Canaan for blessing to the whole world rather than know the curses of disobedience (ch. 28)	God (Suzerain) spoke via Moses (mediator) to renew Israel (vassal) to the Mosaic Covenant and predicted Israel's exile, repentance, and return in the Palestinian covenant (30:1-10).	Israel's foundation of love for and obedience to God (6:4) to experience deliverance in the land parallels the Christian's need to love God as the basic motivation for redemption from sin and successful living today (Luke 10:27).	The promise of prophets like Moses (18:14-22) who instructed Israel in God's laws was fulfilled in many OT prophets, yet ultimately in Jesus (John 6:14; Acts 3:22-23; 7:37).
JOSHUA	God established Israel in Canaan as his co-regents by conquering those rejecting his rule (1-12) and settling their land (13-24) as the reward of their faith.	Israel's faithful subjugation (1-12) and occupation (13-24) of most of Canaan begins to fulfill God's covenant promise to Abraham to give the people a national homeland in partial fulfillment of the Palestinian covenant.	God's deliverance of Canaan into Israel's hands by their faith (1-12) shows the blessings of trust in Him as a Redeeming God (13-24) instead of the cursings of disobedience.	Joshua's leading of Israel over Canaan's foes parallels Jesus, who leads believers victoriously in their battle over sin until they reach rest in the kingdom (Heb. 3-4).
JUDGES	Israel <u>failed</u> to implement God's direct rule over the nation, showing the need for a righteous king to lead the nation under a monarchy (21:25).	Israel's repeated faithlessness to the Mosaic Covenant caused cycles of sin yet not destruction due to God's faithfulness to the Abrahamic Covenant.	God faithfully provided redeemers for Israel (2:18) who serve as forerunners of the redemption in Christ, who also will judge the unrighteous and deliver His children (Rom. 10:13).	Judges raised up by God typify Jesus Christ, the Final Deliver, Judge and Ruler not of a single locale but of the entire world.
RUTH	Ruth and Boaz were <u>rewarded</u> for submitting to God's rule over their individual lives despite the fact that this was not true of the nation as a whole.	Despite national rebellion under the judges (1:1), God's covenant loyalty preserved a righteous remnant through Boaz and Ruth who entered the messianic line (4:17-22) and anticipated the Davidic covenant.	God's salvation came not by judicial reforms but via Ruth and her kinsman-redeemer, Boaz, whose line later redeems the world through their ultimate Redeemer-descendant, Jesus.	Boaz faithfully served as kinsman-redeemer for Ruth (3:9) just as Christ will redeem and mediate man's deliverance from sin as the final Redeemer of the Davidic line.

	KINGDOM	COVENANT	REDEMPTION	MESSIANIC
<b>1 SAMUEL</b>	The <u>transition</u> from a degenerate theocracy under Eli and Samuel (1-7) to a monarchy under Saul and David (8-31) shows how God's sovereignty was delegated to the divinely elected Davidic kings who were to rule justly.	God used Samuel to replace corrupt yet anointed priests with godly leadership in the anointed David to fulfill His covenant promise to provide kings from Abraham's line (cf. Gen. 17:6).	God's commitment to save the nation from her carnal choice of Saul to God's choice of David shows His concern to carry out His redemptive plan despite man's sin.	Samuel's willing transfer of his tri-office of prophet-priest-judge to David's kingship pictures the authority of Christ in these various dimensions.
<b>2 SAMUEL</b>	God delegated His rule to David and his seed by <u>covenant</u> (1-10) and protected his dynasty despite punishing David's sin and the rivals to the throne (11-24).	God restored Israel's unity in the Davidic covenant (7:12-16) that promised an eternal seed, throne, and kingdom and was not conditioned even on David's fidelity (11-24).	Israel's faith in David as redeeming shepherd-ruler (5:2) typifies the redemption faith of other covenant people in the eternal Ruler from David's line who will secure eternal salvation for man.	David portrays Jesus Christ as the divinely chosen king who will maintain a righteous and eternal reign (cf. Matt. 12:23; 21:15; Luke 1:32, 69; Rev. 5:5).
<b>1 KINGS</b>	Solomon relinquished his right to rule over a united kingdom by his disobedience (1-11), yet even after the nation <u>divided</u> God stayed loyal by providing kings in his dynasty so that One may once again rule a united kingdom (12-22).	The failures of Solomon and rulers of the divided kingdom (11:11-12) illustrate God's covenant faithfulness to discipline for the national good but never to destroy the nation entirely due to his promise to David (9:4-5).	Solomon's temple indwelt by God in national redemption despite the division of the kingdom pictures redemption of believers by Christ that should result in worship, holiness and obedience.	Solomon's glorious kingdom, splendor, wealth, and wisdom are a true but poor depiction of the far greater glory, splendor, wealth, and wisdom of Jesus, the ultimate Son of David who did not sin, as did Solomon.
<b>2 KINGS</b>	Continued rejection to rule under God as a monarchy led to the <u>downfalls</u> of both Israel (1-17) and Judah (18-25), yet the Davidic line remained intact.	God's covenant faithfulness blessed kings who obeyed and disciplined those who disobeyed the Mosaic covenant—even in exile—though He still kept David's line.	The exile—not annihilation—of the divided kingdoms was due to God's commitment to redeem humanity later via a Redeemer in the salvation role of Jeroboam II (14:26-27).	The protection of Joash as the last surviving heir to the throne (11:1-3) shows God's unfailing promise of a Messiah from the line of David despite opposition.

	KINGDOM	COVENANT	REDEMPTION	MESSIANIC
1 CHRONICLES	God's sovereign <u>establishment</u> of David's line (1-9) and David's concern for proper temple worship (10-29) reminded Israel not to repeat the idolatry of the past.	The preservation of David's line during the exile (1-9; 17:10b-14) and his priority of worship model the remnant's proper response to God's covenant loyalty.	Redemption from sin is rooted in the establishment of the line of Judah and David (1-9), from whom the final Redeemer will come who is worthy of worship.	Jesus is Messiah at birth in David's unbroken lineage despite Judah's exile (1-9) due to the unconditional promise of God to guard David's seed forever (17:11-14; Luke 1:32-33).
2 CHRONICLES	Rejecting to rule under God ended the rule of Solomon (1-9) and Judah's kings (10-36) yet God <u>preserved</u> David's line to exhort Israel to proper temple worship.	Though Judah's sin ended the nation in exile, God sustained His covenant with King David (7:17-18) as a model of the people's need to worship according to the Mosaic covenant.	God's salvific purposes cannot be thwarted even by exile, for as Cyrus restored Judah (36:22-23), so Christ will appear as Redeemer even from the kingly line under discipline from sin.	Solomon's glorious temple prefigures Christ whose glory will far surpass it when he Himself is worshipped by all nations in the kingdom era.
EZRA	God began restoring his rule to His returned people via Zerubbabel (temple: 1-6) and Ezra (people: 7-10).	Covenant loyalty on God's part seen in restoring the remnant to the land must be shown among the returning remnant in temple worship and holy living to keep David's line pure.	Faithful to His promise to restore the nation (cf. 2 Chron. 36:22-23), God brought the exiles back to the land so that a Redeemer might be born there.	Zerubbabel's role in restoring the exiles to the land prefigures the work of his Descendant who will restore His chosen ones from a life a sin.
NEHEMIAH	God restored Jerusalem's <u>walls</u> (1-7) yet an incomplete restoration of the people (8-13) prevented His rule from extending forth from Zion.	God removed the returning Jews' shame of an unprotected city to exalt them as noted in the Abrahamic covenant and then instructed them in covenant compliance.	Israel's restoration to Jerusalem with protective walls (1-7) and a renewed people (8-13) still lacked a King who would humble himself as did Nehemiah for full redemption.	Like Nehemiah, Christ gave up His privileged position to serve man (2:5; Phil. 2:5-11), fulfilled a mission (6:15; John 19:30) and depended on prayer (1:5-11; Mark 1:35).
ESTHER	God's <u>providence</u> in averting Israel's destruction showed His rule over all nations.	God always protects Israel from extinction (4:14; cf. Jer. 31:35-37), fulfilling His covenant promise to bring the Messiah mostly behind the scenes.	All efforts to destroy God's redemptive plan by annihilating His redemptive people Israel will fail, as did Haman's.	Esther's risk of death for the Jews (4:16) and role as advocate (7:1-6) portray these roles for Christ.

# Integration of the Old Testament

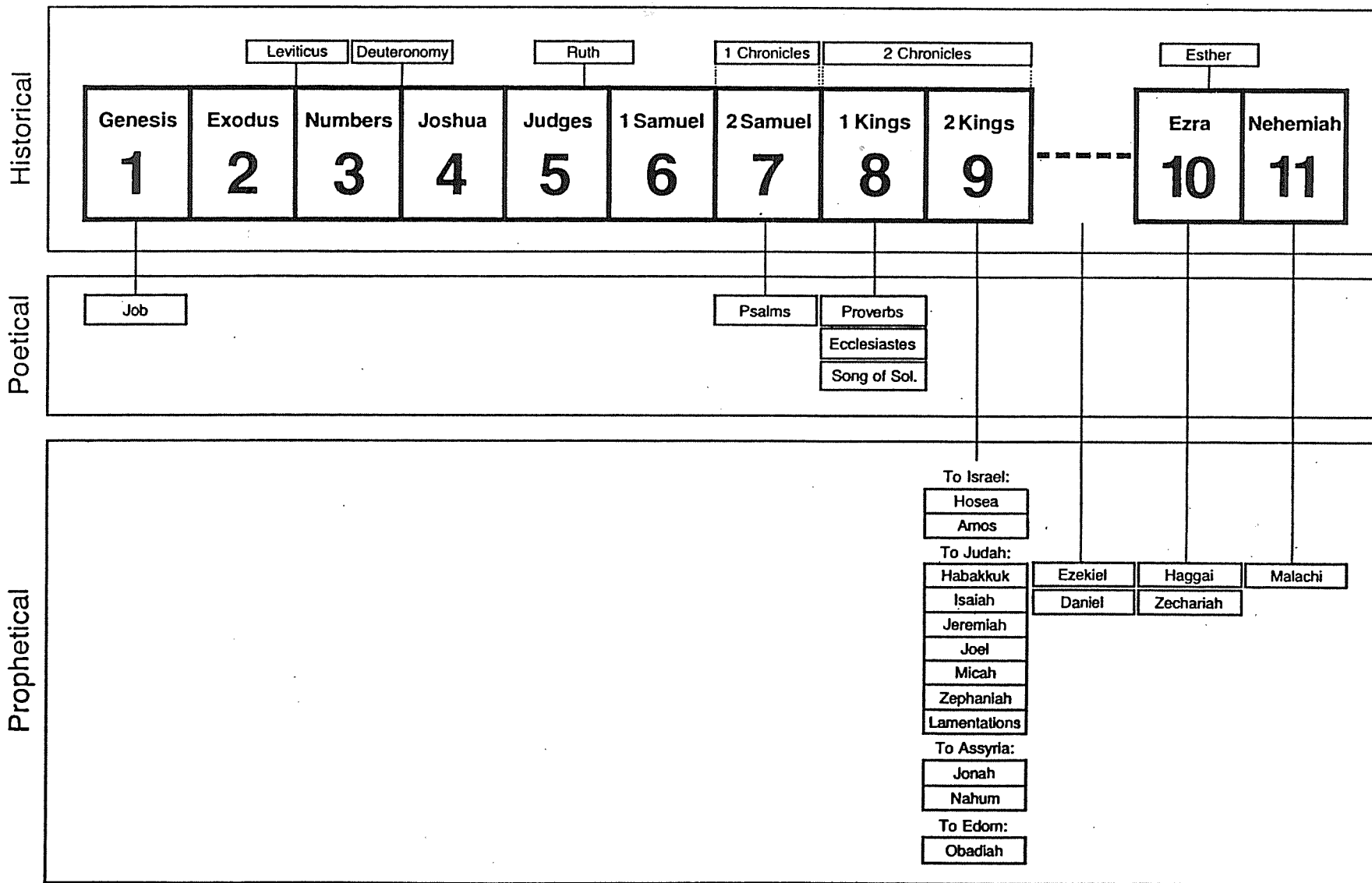

Historical

Poetical

Prophetical

**Integration of the Old Testament**  
Walk Thru the Old Testament (adapted in exilic/postexilic books)

# A Family Tree from Adam to Jesus

John R. Cross, *The Stranger on the Road to Emmaus* (Sanford, FL: Good Seed Int'l, 1996), 174-75

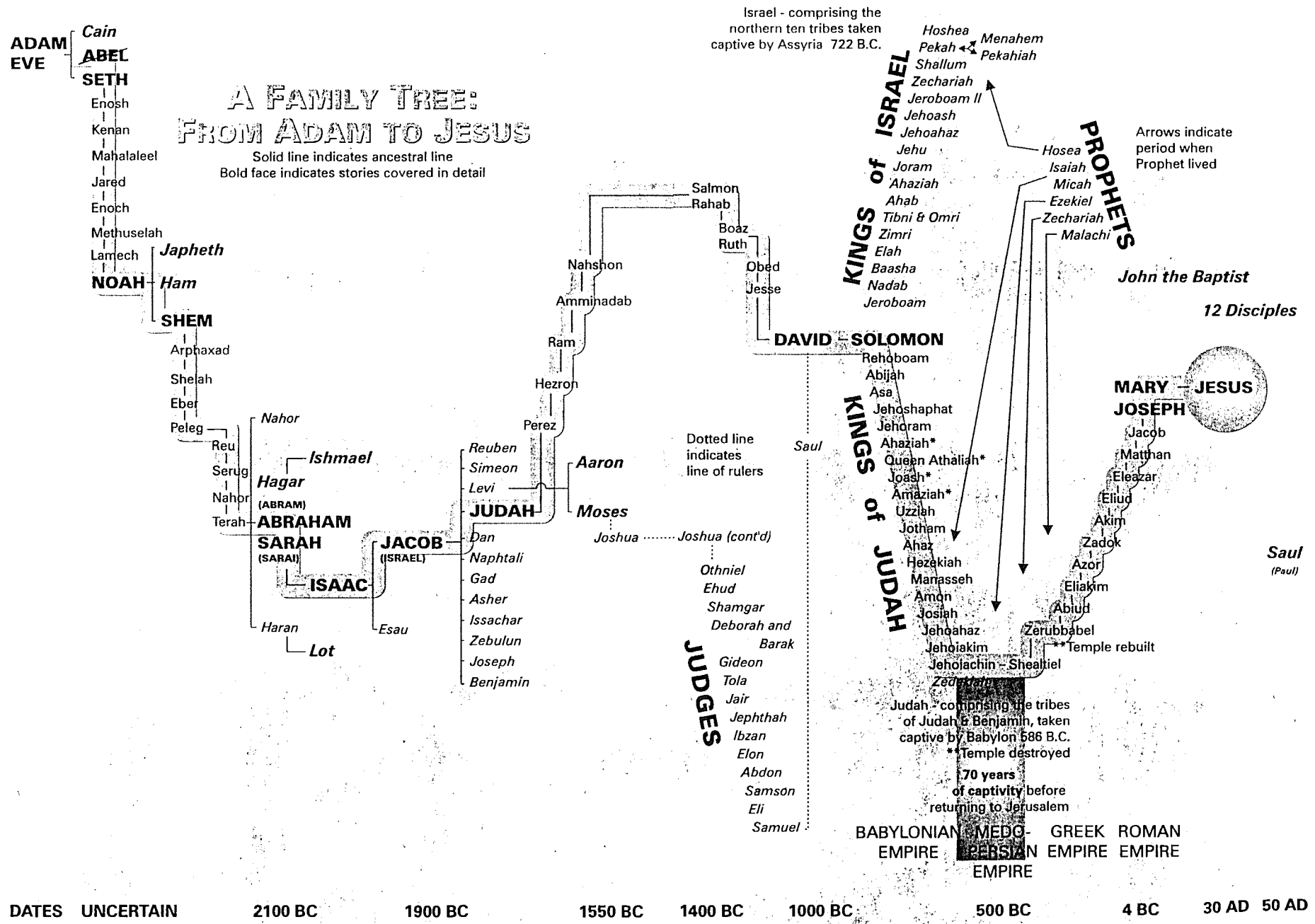

\*Rulers that do not appear in Matthew's account of Jesus' ancestral line.

# Chronology of Historical and Poetical Books

*The Bible Visual Resource Book, 9*

APPROXIMATE TIMES WHEN EVENTS IN EACH BIBLE BOOK HAPPENED

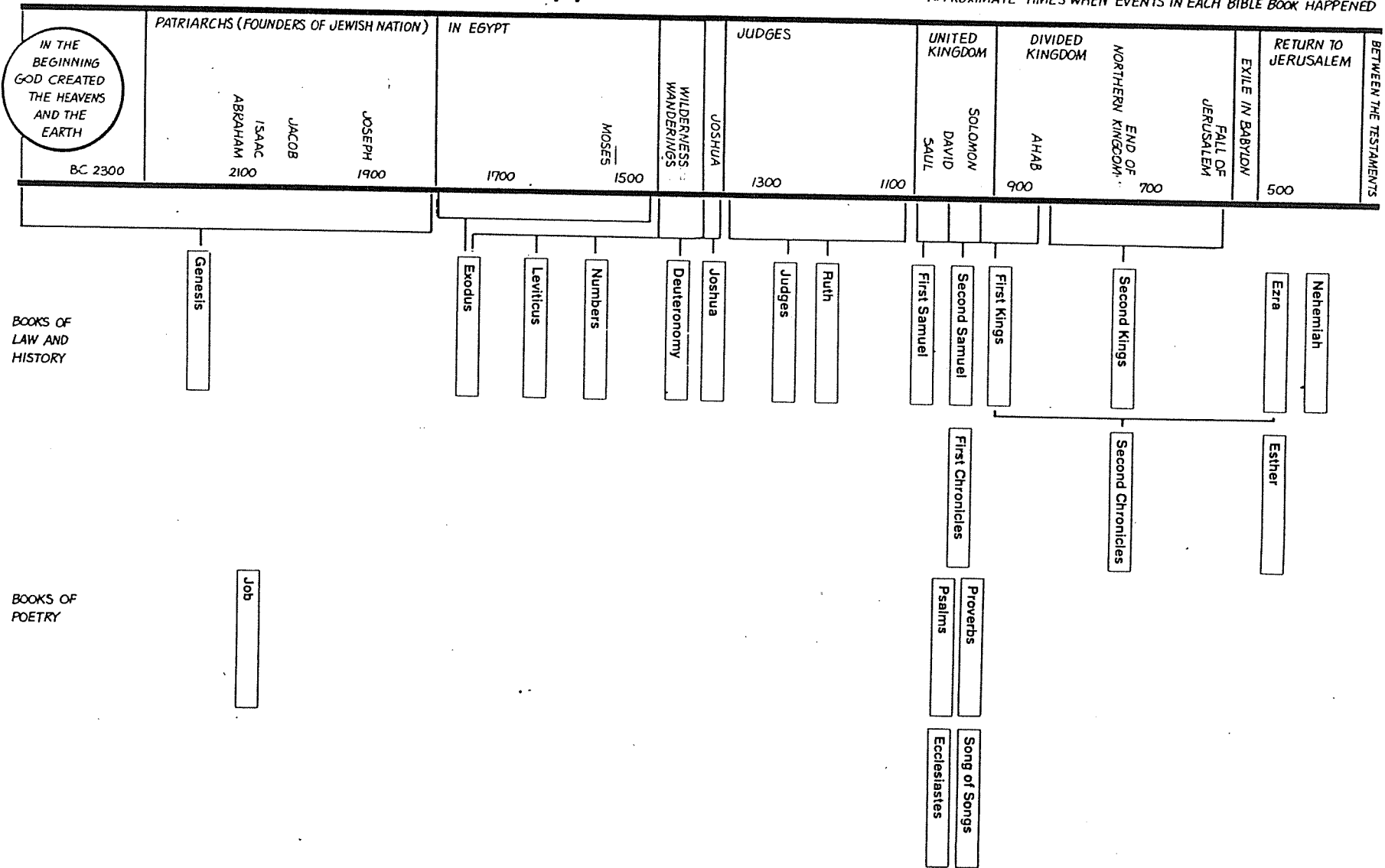

The Books of Prophecy tell about events during the Divided Kingdom, Exile and Return to Jerusalem.

## When Old Testament Events Happened

BOOKS OF LAW AND HISTORY

BOOKS OF POETRY

BOOKS OF PROPHECY



## Introduction

No area of Old Testament studies has been more subject to debate and discussion than that of the authorship and integrity of the books of the Old Testament. Ever since the triumph of critical scholarship in the nineteenth century in Germany, the authorship and integrity of every book in the Old Testament has been challenged with the possible exception of Haggai. The suggestions given in the following chart are of a conservative nature, but they are meant to be an informed conservatism. There is no room in such a chart to list argumentation or to discuss difficulties. For the reader who may be interested in the fascinating study of Special Introduction, there is a list of sources noted.

The reader should also be informed that not all conservative scholars are in agreement with the dates and authorship of some Old Testament books. Whereas it is a mark of evangelical scholars to affirm the Mosaic unity of the Pentateuch (the books Genesis through Deuteronomy), the integrity of the book of Isaiah, and the genuineness of the book of Daniel, there are other issues on which conservatives are divided. Some of these include: (1) the date of the Exodus, and hence, of all history from the patriarchal period until the early monarchy; (2) the date of some prophets, such as Obadiah; (3) the authorship of some difficult books, such as Esther; and (4) the writers of anonymous books, such as Job. Again the reader is encouraged to pursue these issues in the books and materials cited.

Names play an important role in the interpretation of the Old Testament. We do not always have at hand the meaning of a given Old Testament name, but when the name is understood the meaning often contributes to the understanding one has of the individual and his message. For this reason, an effort has been made to give the meanings of the names of the writers of the books of the Old Testament. Many of these name are **the-**

**ophoric**, that is formed with a designation of deity. Names with **Abi-** (such as **Abiel**) refer to God as “father.” Hence, “Abiel” means “(my) father is God.” Names with **El** speak of God and those with **Yah** refer to His personal name, Yahweh.

The term **Yahweh** may be unfamiliar to some, but it is the proper pronunciation of the name of God in the Old Testament. In some Bibles the name is given as **Jehovah** which is the result of a late medieval misunderstanding of the proper designation for God. Hebrew was written without vowels in the ancient period. The name of God was written with four Hebrew consonants, YHWH (the “Tetragrammaton,” or four-letter name for God). When the proper vowels are added, the correct rendering is **Yahweh**, a term believers should learn to reverence, for it is His memorial name for all generations (see Exodus 3:1-15, especially verses 12-15). For this reason, Yahweh is used in the English renderings of the names found in the chart.

## Sources for further study

There are two types of works one may consult for further information on the material of this chart. One category is books on Old Testament introduction and the second is Bible dictionaries and encyclopedias. Each of these books is conservative in orientation.

### (1) Old Testament Introductions

Archer, Gleason L., Jr. **A Survey of Old Testament Introduction**. Revised ed. Chicago: Moody Press, 1974.

Harrison, R. K. **Introduction to the Old Testament**. Grand Rapids: William B. Eerdmans Publishing Co., 1969.

### (2) Bible Dictionaries and Encyclopedias

Douglas, J. D., ed. **The New Bible Dictionary**. Grand Rapids: William B. Eerdmans Publishing Co., 1962.

Kerr, William F., ed. **The Tyndale Family Bible Encyclopedia**. Wheaton: Tyndale House, forthcoming. Seven volumes.

# Authors of the Old Testament

	Passage	Author	Chapters	Meaning of Name	Origin	Occupation
The Pentateuch	Genesis 1- Deuteronomy 33	Moses*	186	"Son of Water"	Israelite Tribe: Levi Born: Egypt Died: Moab	Prince: 40 yrs. in Egypt Herdsman: 40 yrs. in Midian Deliverer: 40 yrs. in Wilderness
	Deuteronomy 34	(Joshua)*	1	"Yahweh is Salvation"	Israelite Tribe: Ephraim Born: Egypt Died: Ephraim	Soldier (Possible that Joshua served in Pharaoh's army before the Exodus) Spy (His selection as one of the 12 spies gave Joshua the opportunity to learn the nature of the Canaanites and the lay of the land — which later proved invaluable to the later conquest) Administrator/Leader
The Historical Books	Joshua 1:1-24:28	Joshua*	24	"Yahweh is Salvation"	Israelite Tribe: Ephraim Born: Egypt Died: Ephraim	Soldier Spy Administrator/Leader
	Joshua 24:29-32	(Eleazar)*	4 vs.	"God has Helped"	Israelite Tribe: Levi 3rd son of Aaron	High Priest
	Joshua 24:33	(Phinehas)*	1 vs.	"The Nubian" (Probable Egyptian origin)	Israelite Tribe: Levi Son of Eleazar	Priest Superintendent of Korahite Gatekeepers (1 Chr. 9:20). Phinehas' descendants held the priesthood unto A.D. 70.

\*Up until fairly recent times, the Mosaic authorship of the first five books of the Old Testament, called the Pentateuch, was commonly held. Such theories as the Documentary Hypothesis however, purport that the Pentateuch is a compilation of selections from several different written documents composed at different places and times over a period of five centuries, long after the era of Moses. In startling contrast to this and many other non-Mosaic authorship theories, conservative scholarship unswervingly points to the overwhelming facts that confirm that the Pentateuch was written within 50 years of the Exodus (ca. 1450 B.C.) and that it was written, as Scriptures clearly state, by Moses. (For a convincing summary of the subject of Mosaic Authorship of the Pentateuch, refer to Archer, pp. 81-118).

\*Deuteronomy 34 is a record of Moses' death and was written probably by an editor. It is not out of order, even today, for an editor to furnish an appendix to an autobiography, giving an account of the author's death. (The Book of Joshua ends the same way). The appendix may have been attached to the document soon after the death of Moses. The author of the appendix could have been Joshua, the intimate friend of the great lawgiver and his successor as the leader of Israel. "He was the one above all others who should have pronounced the eulogy upon his master after his death. Notice the expressions 'Moses the servant of the Lord,' and 'Moses, the man of God.' Neither of these phrases are found in the preceding part of the Pentateuch and it does not appear that Moses even assumed such titles for himself. It was a favorite method with Joshua, however, in speaking of his dead friend and leader. The words 'Moses the servant of the Lord,' occur more than a dozen times in the book of Joshua, and are found in both the narrative matter and the speeches attributed to him. The other expression also was known in his day for Caleb referred to 'Moses, the man of God,' in addressing him." (ZPEB, Vol. 2, pp. 113f.)

\*While the Talmud attributes the book to Joshua, it explains that Joshua's death notice (24:29-32) was written by Eleazar the priest, and that his son, Phinehas, appended the last verse (24:33) which noted Eleazar's death (*Baba Bathra*, 14b-15b).

**Authors of the Old Testament**  
Walk Thru the Old Testament 3 of 5

**The Historical Books**

Passage	Author	Chapters	Meaning of Name	Origin	Occupation
Judges 1-21	(Samuel)*	21	"Name of God"	Israelite Tribe: Levi	Judge Priest Prophet
*The authorship of the Book of Judges is unknown but the Talmud ( <i>Baba Bathra</i> , 14b) identifies Samuel as the author. As the book covers a period of at least 300 years, Samuel acted as an editor/compiler. The individual stories undoubtedly had a history of their own before they were gathered together and therefore may push the number of original authors to a dozen.					
Ruth 1-4	(Samuel)*	4	"Name of God"	Israelite Tribe: Levi	Judge Priest Prophet
*Talmudic tradition ( <i>Baba Bathra</i> , 14b) identifies Samuel as author. Note the phrase "when the judges ruled" (Ruth 1:1) which links it to the Book of Judges. Josephus reckoned Ruth to be an appendix to Judges ( <i>Contra Apionem</i> , 1:8). Ruth 4:22 states "And Obed begat Jesse, and Jesse begat David" which forces authorship until at least the time of David and most probable before Solomon as he is not noted. Samuel would be the logical author especially if he did write Judges.					
1 Samuel 1-14	(Samuel)* (cf. 1 Sam 10:25 for "Then Samuel wrote in a book. . .")	14	"Name of God"	Israelite Tribe: Levi	Judge Priest Prophet
1 Sam 15 - 2 Sam 8	(Nathan)* (cf. 1 Chr 29:29 for "the book of Nathan the prophet.")	25	"Gift"	Israelite Tribe: Unknown	Prophet (Authorship suggested because of his close association with David's court at this time. See note below.)
2 Samuel 9-24	(Gad)* (cf. 1 Chr 29:29 for "the book of Gad the prophet")	16	"Good Fortune"	Israelite Tribe: Unknown	Prophet (Authorship suggested because of his close association with David during this hectic period, compare 1 Sam 22:5. See note below.)
*The authorship of First and Second Samuel is unstated and therefore theoretic. Talmudic tradition ( <i>Baba Bathra</i> 14b) attributed the writing to Samuel, Gad, and Nathan. ZPEB offers a good suggestion with the multiple authorship of 1 & 2 Samuel given to Samuel, Nathan, and Gad (cf. 1 Chr 29:29) with a probable later author/editor who combined their works while also using the Book of Jashar (2 Sam 1:18). "This would account for the smooth transition from section to section and the overall unity of the books. The parts are clearly interrelated and the language is basically the same." (ZPEB; Vol. 5, pp. 260ff.)					
1 & 2 Kings	(Jeremiah)*	47	"Yahweh Establishes"	Israelite Tribe: Levi	Prophet Priest
*The authorship of First and Second Kings is unstated and therefore theoretic. Although no single author could have been associated with the events spanning over four hundred years, it seems that the minute details given indicate that records were kept of the events as they happened throughout the centuries. Therefore, the original number of authors of the book of Kings may number well over 25. Talmudic tradition ( <i>Baba Bathra</i> 15a) asserts that Jeremiah was the author of Kings and since the author speaks from a consistently prophetic standpoint and is a man of great literary ability, it is possible that Jeremiah may have composed everything (from many sources) except the final chapter (Archer, p. 289). It is obvious that the prophetic author drew upon at least four earlier written documents: 1. "The Book of the Acts of Solomon" (1 Kings 11:41) 2. "The Book of the Chronicles of the Kings of Israel" (1 Kings 14:19, etc.) 3. "The Book of the Chronicles of the Kings of Judah" (1 Kings 14:29, etc.) 4. "Isaiah 26-39" compare with 2 Kings 18-20.					

Passage	Author	Chapters	Meaning of Name	Origin	Occupation
1 & 2 Chronicles	(Ezra)*	65	"Yahweh Helps"	Israelite Tribe: Levi Born: Babylon	Priest Scribe/Historian Statesman
<p>*The authorship of First and Second Chronicles is unstated and therefore theoretic. Both Talmudic tradition (<i>Baba Bathra</i> 15a) and modern commentators ascribe authorship to Ezra. Nehemiah collected an extensive library (2 Macc 2:13-15) which was available to Ezra for his research in compiling such a volume. Also in support of Ezra authorship is the fact that the last two verses of 2 Chronicles are identical to the first two of Ezra. As in Kings, the original number of authors may number well over 25. It is obvious that the author drew upon many sources since over half the material contained in the Chronicles is paralleled by other books in the Old Testament — especially Genesis, Samuel, and Kings. Sources may be divided into two classes:</p> <p>LISTED SOURCES OF CHRONICLES: OFFICIAL RECORDS</p> <ol style="list-style-type: none"> <li>1. The Record of Chronicles of King David (1 Chr 27:24)</li> <li>2. The Book of the Kings of Israel and Judah (2 Chr 27:7, 35:27; 36:8)</li> <li>3. The Book of the Kings of Judah and Israel (2 Chr 16:11, 25:26; 28:26; 32:32)</li> <li>4. The Book of the Kings of Israel (1 Chr 9:1; 2 Chr 20:34)</li> <li>5. The Words of the Kings of Judah (2 Chr 23:18)</li> <li>6. The Commentary on the Book of Kings (2 Chr 24:27)</li> <li>7. The Decree of David the King of Israel and the Decree of Solomon his Son (2 Chr 35:4)</li> </ol> <p>LISTED SOURCES OF CHRONICLES: PROPHETIC RECORDS</p> <ol style="list-style-type: none"> <li>1. Samuel the Seer (1 Chr 29:29)</li> <li>2. Nathan the Prophet (1 Chr 29:29; 2 Chr 9:29)</li> <li>3. Gad the Seer (1 Chr 21:9)</li> <li>4. Ahijah the Shilonite (2 Chr 9:29)</li> <li>5. Iddo the Seer (2 Chr 9:29; 12:14; 13:22)</li> <li>6. Shemaiah the Prophet (2 Chr 12:14)</li> <li>7. Jehu, the Son of Hanani (2 Chr 20:34)</li> <li>8. Isaiah the Prophet (2 Chr 26:22)</li> <li>9. "The Chronicles of the Seers" (2 Chr 33:19)</li> </ol> <p>In addition to the above, the author/compiler had genealogical lists, official documents such as the message of Sennacherib (2 Chr 32:10-15); the letters of Sennacherib (2 Chr 32:17); the words of Asaph and David (2 Chr 29:30); and the documents with the plans for the temple (1 Chr 28:19).</p>					
Ezra 1-10	(Ezra)*	10	"Yahweh Helps"	Israelite Tribe: Levi Born: Babylon	Priest Scribe/Historian Statesman
<p>*The books of Ezra and Nehemiah originally were regarded by the Jews (Talmud, <i>Baba Bartha</i>, 15a) as a single work by one author/compiler — Ezra. The author made extensive use of documents and often inserted them word for word. In addition to the <i>Memoirs of Ezra</i> in the first person singular (7:27-9:15) which is followed and preceded by third person narratives (7:1-26;10) that could be based on a record made by Ezra himself, the following are additional sources used in the writing of the present book:</p> <p>LISTED SOURCES FOR THE BOOK OF EZRA</p> <ol style="list-style-type: none"> <li>1. List of returned exiles with Zerubbabel (2: cf. Nehemiah 7)</li> <li>2. Letter of complaint to Artaxerxes I about the rebuilding of the city walls and his reply (4:8-24)</li> <li>3. Letter to Darius I and his reply (5:1-6:18)</li> <li>4. Official authorization of Artaxerxes to return to Jerusalem with people and money (7:12-26)</li> <li>5. List of those who returned with Ezra (8:1-14)</li> <li>6. List of those who married pagan wives (10:18-43)</li> </ol>					

## Authors of the Old Testament

Walk Thru the Old Testament 5 of 5

	Passage	Author	Chapters	Meaning of Name	Origin	Occupation
The Historical Books	Nehemiah 1:1-7:5; 11:27-12:43; 13:4-31	Nehemiah*	9	"Comfort of Yahweh"	Israelite Tribe: Levi? Born: Babylon	Cup-bearer Statesman Governor of Jerusalem (7:2)
	Nehemiah 7:6- 11:26; 12:44- 13:3	(Ezra)*	4	"Yahweh Helps"	Israelite Tribe: Levi Born: Babylon	Priest Scribe/Historian Statesman
<p>*The books of Ezra and Nehemiah originally were regarded by the Jews (Talmud, <i>Baba Bathra</i>, 15a) as a single work by one author/compiler — Ezra. The author made extensive use of documents and often inserted them word for word. In addition to the personal <i>Memoirs of Nehemiah</i> in the first person singular (1:1-7:5; 11:27-12:43; 13:4-20), the following were additional sources used in the writing of the present book:</p> <p>LISTED SOURCES FOR THE BOOK OF NEHEMIAH</p> <ol style="list-style-type: none"> <li>1. List of the builders of the wall and the sections where they worked (3)</li> <li>2. List of returned exiles with Zerubbabel (7; cf. Ezra 2)</li> <li>3. List of the leaders who set their seal to the covenant (10:1-27)</li> <li>4. List of the allocation of the people in Jerusalem and neighborhood (11)</li> <li>5. List of priests and Levites down to Jaddua (12:1-26)</li> </ol>						
	Esther 1-10	(Mordecai)*	10	"Related to Marduk"?	Israelite Tribe: Benjamin Deported by Nebuchadnezzar to Babylonia	Government Official in Persia
<p>*The Book of Esther is anonymous and suggestions as to its author generally include Mordecai, Ezra, or Nehemiah. Jewish authorities record the tradition (as old as Josephus) that Mordecai was the author. Note such phrases as "Mordecai wrote these things" (9:20); "as Mordecai had written unto them" (9:23); and "Mordecai, the Jew, wrote with all authority" (9:29ff). Archer (p. 417) points out that the other possible authors of Ezra and Nehemiah are weak as neither offer good linguistic evidence as far as similarity of their writings in style or diction to the Book of Esther. The author evidently used at least the following sources:</p> <p>SOURCES LISTED IN ESTHER</p> <ol style="list-style-type: none"> <li>1. "The Book of the Chronicles" (2:23)</li> <li>2. "The Book of the Records of the Chronicles" (6:1)</li> <li>3. "The Book of the Chronicles of the Kings of Media and Persia" (10:2)</li> </ol>						
The Poetical Books	Job 1-4	(Anonymous)*	42		Many feel authorship is non-Israelite	
	<p>*The text of this book does not indicate its author, and there is no consistent tradition even in rabbinic circles who the composer might be. Suggestions include Job, Moses, Solomon, Jeremiah, and a host of others. The source of this wide-spread disagreement of authorship stems from the fact that the Book of Job contains no references to historical events and reflects a non-Hebraic cultural background concerning which little information is currently available and therefore the dating of the lifetime and career of Job is highly subjective.</p>					
	Psalms 3-9, 11-32, 34-41, 51-65, 68-70, 86, 101, 103, 108-110, 122, 124, 131, 133, 138-145.	David (Possibly Psalms 2 and 33 were written by David, cf. New Testament)	73	"Beloved of Yahweh"	Israelite Tribe: Judah	Shepherd Musician Warrior King

## Hebrew Bible Arrangement

John H. Walton, *Chronological and Background Charts of the OT*, 2d ed., 12, adapted

HEBREW NAMES FOR THE BOOKS	HEBREW ARRANGEMENT AND CLASSIFICATION	ENGLISH ARRANGEMENT AND CLASSIFICATION	APPROXIMATE DATES CONCERNED
In the beginning These are the names And He called In the wilderness These are the words	TORAH	Genesis Exodus Leviticus Numbers Deuteronomy	Genesis Exodus Leviticus Numbers Deuteronomy
Joshua Judges I Samuel II Samuel I Kings II Kings	FORMER PROPHETS	Joshua Judges Ruth I Samuel II Samuel I Kings II Kings	LAW (Pentateuch)
Isaiah Jeremiah Ezekiel Hosea Joel Amos Obadiah Jonah Micah Nahum Habakkuk Zephaniah Haggai Zechariah Malachi	LATTER PROPHETS <small>"The Twelve"</small>	Isaiah Jeremiah Ezekiel Hosea Joel Amos Obadiah Jonah Micah Nahum Habakkuk Zephaniah Haggai Zechariah Malachi	HISTORY
Praises Job Proverbs Ruth Song of Songs The Preacher How! Esther Daniel Ezra Nehemiah I The words of the days II The words of the days	THE WRITINGS (Hagiographa)	Job Psalms Proverbs Ecclesiastes Song of Solomon Isaiah Jeremiah Lamentations Ezekiel Daniel Hosea Joel Amos Obadiah Jonah Micah Nahum Habakkuk Zephaniah Haggai Zechariah Malachi	POETRY and WISDOM
			MAJOR PROPHETS
			MINOR PROPHETS

Bracketed books are single books  
in the Hebrew arrangement of  
24 OT books

# English Bible Arrangement

*The Bible Visual Resource Book, 7*

The word "testament" means "will" or "covenant." The term "Old Testament," therefore, refers first to God's covenant or promise-law to bless mankind through the Jewish nation. It has also come to refer to the *writings about* the Old Covenant, although, strictly speaking, these ancient books are the Old Covenant *Scriptures*.

## Purpose/Theme:

The Scriptures of the Old Testament record the story of God's chosen people, Israel, and their relationship to His covenant to bless all nations through them.

### The Books of Law

Genesis
Exodus
Leviticus
Numbers
Deuteronomy

### The Books of History

Joshua
Judges
Ruth
First Samuel
Second Samuel
First Kings
Second Kings
First Chronicles
Second Chronicles
Ezra
Nehemiah
Esther

### The Books of Poetry

Job
Psalms
Proverbs
Ecclesiastes
Song of Songs

### The Books of Major Prophets

Isaiah
Jeremiah
Lamentations
Ezekiel
Daniel

### The Books of Minor Prophets

Hosea
Joel
Amos
Obadiah
Jonah
Micah
Nahum
Habakkuk
Zephaniah
Haggai
Zechariah
Malachi

## HOW WE GOT OUR BIBLE / PART ONE

by Terry Hall

**BEGINNING WITH MOSES, GOD USED A LONG LINE OF AUTHORS TO CREATE HIS WRITTEN REVELATION.**

# How We Got Our Old Testament

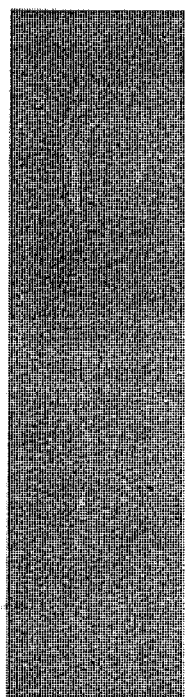

It had to be the strangest publishing project of all time. No editor or publishing house was responsible to oversee 40 independent authors, representing 20 occupations, living in 10 countries during a 1,500-year span, working in three languages with a cast of 2,930 characters in 1,551 places. Together they produced 66 books containing 1,189 chapters, 31,173 verses, 774,746 words, and 3,567,180 letters. This massive volume covers every conceivable subject, expressed in all literary forms—

*Terry Hall is vice president of Media Ministries, Wheaton, Ill., and author of nine books, including Bible Panorama (Victor Books).*

prose, poetry, romance, mystery, biography, science, and history.

What was the final product? *Reader's Digest*? No. The Bible!

One evidence that the Bible is a supernatural book is the unity it displays despite such wide differences among authors, cultures, and forms of expression.

Many Christians wonder how the Bible was put together. Believing God was the ultimate author, they also know the Bible wasn't dropped from heaven or discovered in a cave. So who decided which books would be included or excluded? And are we sure we have all those and only those books God intended?

No one can point to a specific place and day when the Bible was "born." It didn't come into being like a modern book, which is written and edited, then published on a certain date.

The Bible is a collection of 66 books (*Bible* means "the books"), but unlike an ordinary anthology, it was not a committee project in which scholars debated and voted on a roster of candidate books. Each Bible portion was treasured in its own right first and then added to the gradually growing collection of sacred books.

The final collection of sacred books is called the *canon* (from a Greek word for a measuring stick). The Bible books became the standard by which all other writings are measured, for they alone are

vested with God's authority.

God set the stage for Scripture by creating humans with their ability to form languages and alphabets, knowing he would communicate through them. In the beginning, God communicated directly with individuals, but in Moses' time he began to add a written record of his revelation.

Paul later called the process *inspiration* ("to breathe in"; 2 Tim. 3:16), and Peter defined it as men writing "from God as they were carried along by the Holy Spirit" (2 Peter 1:21).

## The Hebrew Writers

Jesus and many other Bible authors agree that Moses began the Bible about 1,450 years before Christ, writing at God's command (Luke 24:27; 2 Chron. 35:6). Moses' first five books comprise about one-fourth of the Old Testament or one-sixth of the whole Bible. They are considered a unit known as the *Law*, *Pentateuch* (Greek for "five books"), or *Torah* (Hebrew for "law").

Moses and other Old Testament prophets wrote in Hebrew. Its letters are written from right to left. Hebrew books are read from back to front. A few Old Testament chapters were later written in Aramaic, another Semitic language, using the same characters as Hebrew (Ezra 4:8-6:18; 7:12-26; Dan. 2:4b-7:28).

Ancient authors used whatever smooth surface was available—stones, clay tablets, but mainly parchment (dried and polished skins of calves or sheep). Pen-and-ink writing was done on scrolls (long strips of parchment sewn together and wound around poles like window shades). By the time of Jesus, Greek had become the world's trade language, and writing was done on papyrus (the soft, inner parts of reeds, pressed and rolled together).

Moses' writings were immediately considered to be from God and stored in the most holy place of the Hebrews' worship center (the sacred ark of the covenant; Deut. 31:24-26). Later they were transferred to the temple in Jerusalem.

The divine authority behind Moses' message was obvious, confirmed by miracles. Those who challenged him were stricken with leprosy or swallowed alive by the earth (Deut. 34:10,11; Num. 12:6-10; 16:28-35). Throughout the rest of Bible history, the Pentateuch was the basis for Jewish faith and life. Psalms quotes from it extensively, and it was the basis for the prophets' messages.

Having predicted God would raise up a line of prophets like himself, Moses be-



How We Got Our Old Testament (2 of 3)

gan a chain of Old Testament written revelation that continued for about a thousand years (from 1400 to 400 B.C.; Deut. 18:15-22). Moses' successor, Joshua, accepted the Law as one divine unit and added his sacred writings to the book of Moses, probably beginning with Deuteronomy 34 (the record of Moses' death; Josh. 1:7,8; 24:26).

The author of Judges-Ruth, which was originally one book, probably began with Joshua 24:28 (Joshua's death). Later Samuel added his history to the book, probably starting with David's family tree in Ruth 4:17 (1 Sam. 10:25). Nathan and Gad completed the history of David, starting with 1 Samuel 25:1 (Samuel's death; 1 Chron. 29:29,30).

Samuel, Kings, and Chronicles (originally one book each) cover 500 years of Hebrew history and were written as a continuous narrative by a succession of prophets (2 Chron. 9:29; 12:15; 13:22; 20:34; 26:22; 32:32).

The writings of Moses, Joshua, Samuel, and the other prophets were stored in the tabernacle and venerated. Only writ-

ings from God's recognized prophets were collected, as the New Testament assures us (Heb. 1:1; 2 Peter 1:20,21).

The prophets were conscious of recording God's word, though they didn't always understand it (1 Peter 1:10-12). More than 3,800 times they claimed to be speaking or writing God's words with "The Lord says . . ." or "Hear the word of the Lord . . ." (Isa. 3:16; 1:10).

God repeatedly exhorted the Hebrews to heed the prophets as his spokesmen, accrediting their messages with supernatural signs and fulfilled prophecies. True prophets were allowed no margin for error; if they were not 100 percent accurate, they were to be killed. Disobeying a prophet of God brought severe penalties (Deut. 13:1-5; 18:17-22).

The Old Testament Scriptures ("sacred writings") formed an assembled collection when the last books were written in Ezra's time (about 425 B.C.). Jewish tradition says Ezra collected the remaining books after the Jews returned from the Babylonian exile. The invaders had destroyed or scattered many copies.

Confirmed by Christ

For several centuries before Christ, the Jews revered the same Hebrew Old Testament they (and we) have today; it was the basis for their law and worship. There was no question about the authenticity of the collection.

The Lord Jesus Christ confirmed the authority of the Old Testament, calling it the Word of God and assuring his followers that neither the smallest Hebrew letter nor the least stroke of a pen would fall from it until all was fulfilled (Matt. 15:3-6; 5:18). He ordered his earthly life by the Old Testament Scriptures, taught and interpreted their principles, and appealed to them as the ultimate authority in temptation or dispute. Jesus said Moses and his writings were a more powerful witness from God than someone rising from the dead (Luke 16:31)!

Our Lord's view of the Old Testament settles the issue for most Christians; the authority of Christ and Scripture stand together.

Jesus' apostles shared their Master's view of the Old Testament, saying of it, "Prophecy never had its origin in the will of man, but men spoke from God as they were carried along by the Holy Spirit" and "All Scripture is God-breathed and is useful for teaching, rebuking, correcting and training in righteousness" (2 Peter 1:21; 2 Tim. 3:16).

Our Old Testament books are unquestionably the ones received and believed by Jesus and his apostles as the Scriptures. The New Testament quotes from nearly all 39 books as authoritative. Of the New Testament's 260 chapters, 209 quote the Old Testament. The New Testament is unanimous in considering the former testament a completed unit with a continuous story, calling it all "the Law" or "the Law and the Prophets."

Jesus said the Old Testament revelation spanned from Genesis to 2 Chronicles (the first and last books in the Hebrew Bible; Luke 11:50,51). Much evidence exists as to which books were considered part of the sacred collection.

Josephus, a respected Jewish historian (A.D. 37-95), said no Hebrew scriptures were added after the time of the Persian King Artaxerxes (464-424 B.C. — the era of Ezra, Nehemiah, and Malachi) "because the exact succession of the prophets ceased . . . no one has dared to add anything to them, or to take anything from them, or to alter anything in them . . . only 22 books, which contain the records of all time, and are justly believed to

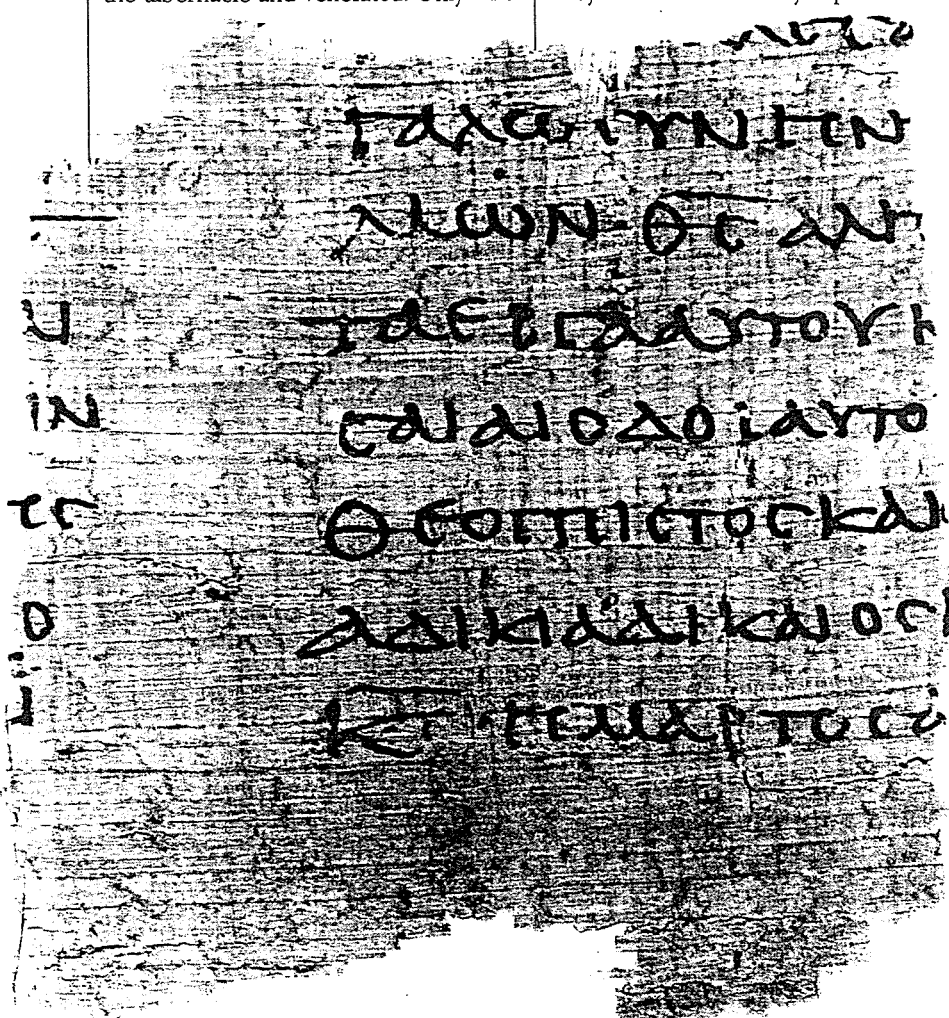

A fragment of a papyrus codex from Deuteronomy 32:3,4

## How We Got Our Old Testament (3 of 3)

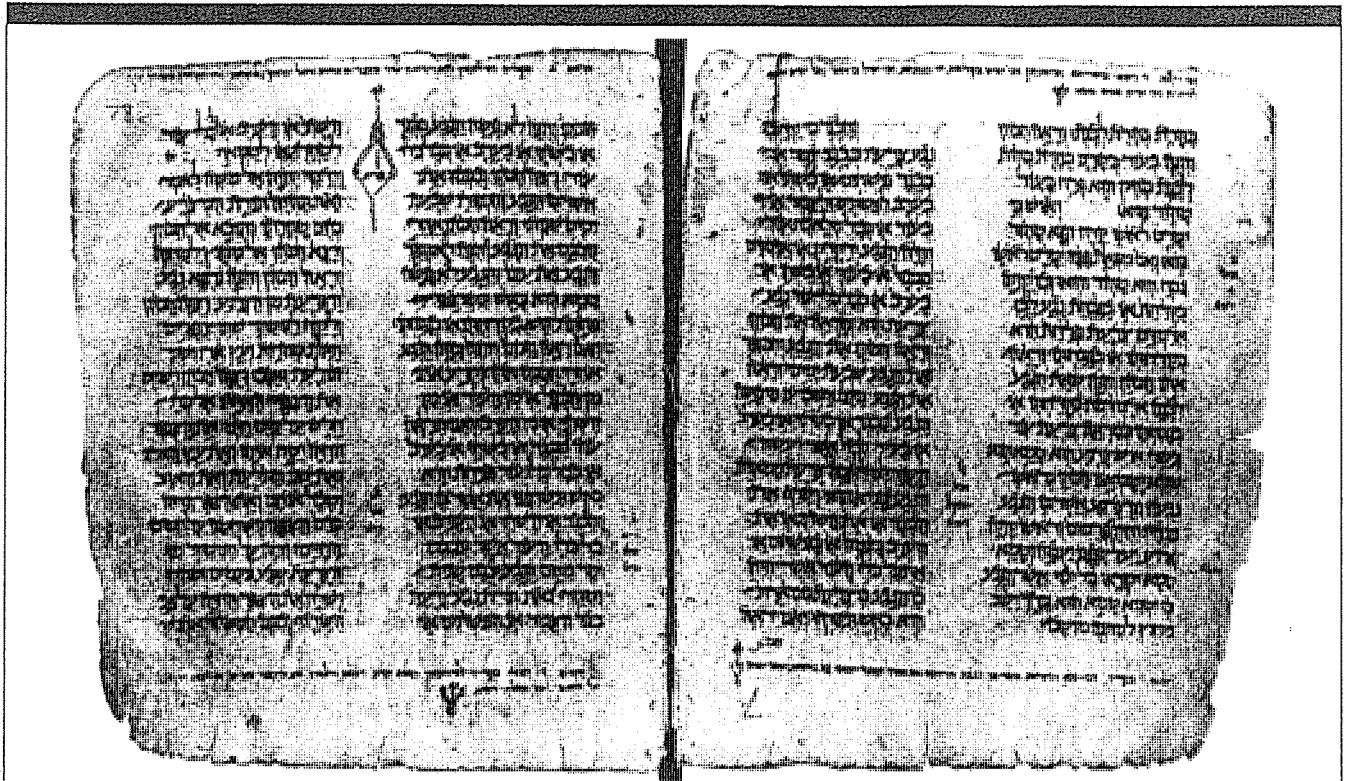

Pages from a 10th century Hebrew Pentateuch

be divine.” (Josephus combined Ruth with Judges and Lamentations with Jeremiah to make 22 books.)

The Hebrew Bible has a different order and smaller number of books, but the exact same content as in our modern English Bibles. Its number of books is reduced to 24 by combining the pairs of Samuel, Kings, Chronicles, and Ezra-Nehemiah into one book each and by grouping all 12 Minor Prophets into one book (called *The Twelve*). The English arrangement stems from the Septuagint (the Greek version of the Old Testament, so called for its 70 translators).

The Septuagint, done about 200 B.C., bears silent witness that the Old Testament canon was complete and considered divine before that time. The now-famous scrolls discovered since 1946 in the Qumran caves near the Dead Sea date from about 250 B.C. They include copies of every Old Testament book except Esther. Other literature of the Essenes (the Jewish monastic community at Qumran) quotes from the Torah, Psalms, Proverbs, and many prophets as authoritative.

### Reassuring Questions

About A.D. 90 at Jamnia (or Jabneh, a town near Joppa), an official council of Jewish leaders ratified the Old Testament canon, which had already been accepted for nearly 500 years. In the process, they questioned Esther for not mentioning God's name, the Song of Solomon for being sensual, Ecclesiastes for being skepti-

cal, Ezekiel's description of the temple for contradicting Moses', and Proverbs for being self-contradictory.

But closer scrutiny resolved their questions. God's Hebrew name (YHWH) is found four times as an acrostic in Esther's margin, and God's power and protection was evident in saving the Jewish race from an annihilation decree. Song of Solomon is a picture of God's love for Israel. Ecclesiastes presents an accurate description of humanity's search for meaning in life apart from God. Ezekiel's temple is to be built when Messiah returns. And the apparently contradictory Proverbs apply to different situations (two different Hebrew words are used for "fool" in 26:4,5).

Such questioning helps assure us that succeeding generations didn't unthinkingly accept what they received. No Old Testament book was removed from the sacred collection, and other ancient books were flatly rejected at Jamnia.

For about 1,900 years after their completion, only the 39 Old Testament books as we know them were considered sacred. Books known as *apocrypha* ("hidden") were produced between 200 B.C. and A.D. 100. But they were not added to the Roman Catholic Bible until 1546, at the Council of Trent, in reaction to the Protestant reformers. The New Testament never quotes from the Roman Catholic Apocrypha, nor were they accepted by Jerome, who made the Catholics' official Latin version. The Apocrypha doesn't

claim to be scripture or the work of prophets, but provides an interesting history of the times between the Bible's two testaments.

The Bible is a collection of authorized books flowing from the mind of God through the pens and personalities of his prophets. Individual Bible authors didn't always know how their work would fit into the book's overall plan. Today, beyond the cross of Calvary, it's easier to see how each piece of the Bible puzzle fits together perfectly.

The Bible has one main plot fully developed from beginning to ending. From book one to 66, the Bible library consistently depicts:

One true, eternal God, the source of all life and good • Man's inability to remain faithful to God, even under ideal conditions • God ever seeking to draw people into a relationship with himself • One diabolical head of the forces of darkness • Salvation from damnation as a gift from God received by faith • A central focus on the Lord Jesus Christ, with the Old Testament looking forward to his coming and the New Testament looking for his coming again.

Only God could have given such a book, so marked by consistency and lacking any unsolvable contradiction. Read any part of it and you encounter the plan of God the Father, the person of Jesus Christ, and the power of the Holy Spirit. ■

Next month: *The New Testament canon*  
(See NT Survey Notes) ←



Scroll discovery after Qumran Cave 4

*Who would have guessed that shepherds, scholars, and grave robbers would serve a divinely appointed mission?*

# The Quest for the Original Bible

*by Robert L. Hubbard*

**I**t was April 1844. The young man leaned lazily on the ship's railing as the beautiful Italian coastline receded behind him, unnoticed. His thoughts were riveted elsewhere.

For Constantin Tischendorf, this was no pleasure cruise. The German Bible scholar was headed for Egypt on a unique treasure hunt.

He would canvass monasteries in the Middle East in search of the earliest New Testament manuscript. His hunch was

The Quest for the Original Bible (2 of 5)

that somewhere among the desolate sands monks had copies far older than those available.

But Tischendorf was not alone. During the past two centuries, many such unsung heroes — people even Indiana Jones would admire — have discovered ancient Bible manuscripts. What follows are some of their stories.

Why the Quest?

Why search for ancient biblical manuscripts? The Bible's original Hebrew and Greek manuscripts (called "autographs") probably have vanished. Written on fragile materials like leather and papyrus, they could not survive centuries of changing weather and constant use. Hence, they lived on only in copies made by devoted scribes.

Long before the convenience of modern technology, one common way to copy the Bible was for one scribe to read his "original" (the best copy he had) line by line as other scribes wrote down what he read. When done, they would have as many new copies of Scripture as there were scribes writing.

Unfortunately, this opens the door for subtle mistakes in the transcription. For example, in Greek the pronouns you and we sound similar. A scribe who wrote what he heard could easily

confuse them. This seems to explain why 1 Corinthians 7:15 reads "God has called you to live in peace" in some ancient manuscripts, while others state "God has called us to live in peace."

Furthermore, some scribes even harmonized parallel passages. For example, in Luke 5:30 the Pharisees ask Jesus, "Why do you eat and drink with tax collectors and sinners?" So one ancient scribe added "and drink" to the same episode reported in Mark 2:16. Later scribes, sincerely devoted to preserving the text, copied and recopied those changes.

As a result, the thousands of manuscripts now available have many minor differences. Footnotes in our Bibles (for example, "other ancient manuscripts read...") point to variations the translators consider more important.

These differences, however, do not affect the Bible's message. The manuscripts teach the same gospel and the same doctrines. Nevertheless, because the Bible is God's Word, translators seek to work from a manuscript that is as close to the autographs as possible, in this way preserving God's intended message.

That's why the search for ancient biblical manuscripts is so important. The earlier the manuscripts, the more like the original they will be — and the better our understanding of what the Bible says.

Mount Sinai. Greek Orthodox monks had lived there since about A.D. 500. And in 1761, an Italian visitor had reported seeing an impressive manuscript.

One day Tischendorf noticed a large basket full of old parchments in the library. According to the librarian, it was trash, destined to heat the monastery oven. Two other basketfuls had already stoked the fire. Among the "trash," Tischendorf found 129 large pages of a very old Septuagint (Greek Old Testament) manuscript.

Unfortunately, his excitement betrayed that the trash was in fact great treasure, and the monks let him take home only 43 pages. In 1846, he published them, dating them to the mid-fourth century A.D.

On his second visit to St. Catherine's in 1853, he failed to find the remaining pages. Tischendorf feared that they had already gone up in smoke.

Nevertheless, in 1859 he made a third visit. He got the czar of Russia, a man revered by eastern monasteries, to fund the trip — a wise move, as it turned out.

Despite the monks' cordial welcome, this visit at first also seemed a failure. When several days of searching through other manuscripts turned up nothing, Tischendorf resigned himself to returning empty-handed. On February 4, the night before his departure, he joined the monastery's steward for some refreshment.

There he struck pay dirt. Holding a gift from Tischendorf, a newly published Septuagint, the host said, "And I, too, have read a Septuagint." He then pulled from the shelf over the door a bulky volume wrapped in a red cloth.

Speechless, Tischendorf unwrapped what he later called "the most precious biblical treasure in existence." Inside were the pages he had seen 15 years earlier, other parts of the Old Testament, the whole New Testament, and two other early Christian writings.

Only Tischendorf's delicate diplomacy, however, gave that treasure to the world. This time he carefully concealed his excitement. He first negotiated permission to take it to Cairo to copy — a feat finished in only two months.

Then he convinced the monks to give the manuscript to the czar. When a dispute between bishops threatened the plan, Tischendorf negotiated a compromise. He would take the text to the czar, but return it if the new archbishop disapproved.

Three years later, Tischendorf published an edition of what is now called the Codex Sinaiticus. (A codex is a book-



A page of Tischendorf's prize: Codex Sinaiticus (A.D. 350-400)

The Wastebasket Clue

Two early manuscripts were found in the 19th century. A revived interest in ancient history had sent European scholars in all directions. The early shovels of modern archaeology unearthed ancient cities from Mesopotamia to Greece. Knowledge of the ancient world was increasing.

Amid that excitement, and with a firm faith in the Bible's authority, Constantin Tischendorf set out to search monasteries for the earliest New Testament manuscript.

His first stops after arriving in Egypt proved fruitless. But in May 1844 he reached the Monastery of St. Catherine, a small fortress-like structure at the foot of

Dr. Hubbard is associate professor of Old Testament at Denver Conservative Baptist Seminary.



## The Quest for the Original Bible (3 of 5)



**St. Catherine's Monastery: a sixth century treasury of parchments and piety guarded by stout walls and the Sinai desert**

like collection of parchment or papyrus pages.)

For years the Sinaiticus resided in Russia in the library at St. Petersburg. In late 1933, however, the Soviet regime needed hard currency to buy machinery. After haggling with several buyers, it sold the manuscript to the British Museum for more than half a million dollars — a clue to its immense value.

The only complete copy of the Greek New Testament in uncial (rounded capital) letters, it is an early manuscript (A.D. 350-400) and ranks among the three most valuable complete Bible texts. Bible

readers owe a great debt to the persistence of Constantin Tischendorf.

#### A Prize of War

The 19th century also yielded knowledge of a second valuable text, the Codex Vaticanus. The Vatican Library had owned it since Pope Nicholas V, a collector of ancient texts, brought it to Rome in 1448. It was listed in the library's first catalog (1475), but for centuries no one knew its value.

Rome's tight grip prevented scholars, especially those who were Protestant, from studying it. Rome's defensive stance

is understandable. The 16th century Reformation had battered the Vatican with criticism; thousands of Catholics had become Protestants.

Napoleon gave scholars their first look. He had long dreamed of collecting Europe's best paintings and archives. When Pope Pius VII refused to side with France against England, Napoleon moved to realize some of that dream.

In 1809, his army occupied Rome and sent the pope into exile at Genoa, Italy. He then had the entire papal archive, including Codex Vaticanus, shipped to France as a prize of war. The next year,

## The Quest for the Original Bible (4 of 5)

Leonard Hug, a German scholar, studied Vaticanus and announced its importance.

That glimpse whetted scholars' appetites. When Vaticanus returned to Rome in 1815 after Napoleon's fall, scholars pressured the Vatican to loosen its jealous grip. Once again, current events — this time, political revolutions in Europe that attacked the Catholic church — put Rome on the defensive. Nevertheless, after waiting several months, Tischendorf was allowed six hours with it in 1843.

Two years later, Rome granted English scholar Samuel Tregelles more time, but he was forbidden to make any notes or to copy any words. On each visit, attendants searched his pockets for writing materials. If he looked too intently at any one passage, they whisked the text away.

Finally, the persistence of Tischendorf paid off. In 1866, the Vatican allowed him to study it three hours a day under the eyes of an appointed official. It soon revoked that permission, however, when it learned he had copied 20 pages in eight days, a violation of the agreement.

His fervent plea gained him six more days and resulted in his publishing an edition of the text in 1867. A photographic edition issued 22 years later finally gave other scholars a long-awaited look.

Codex Vaticanus is even more valuable than Sinaiticus. It is the oldest and most complete Septuagint manuscript (though it lacks most of Genesis and Psalms 106-138). Its New Testament text is very early (A.D. 350-400) and is missing only the end of Hebrews, 1 and 2 Timothy, Titus, Philemon, and Revelation. With Sinaiticus, it may have been among the 50 Bibles prepared by Eusebius, the early church leader and historian, for Emperor Constantine about A.D. 320.

### The Egyptian Connection

Before the discovery of Sinaiticus and Vaticanus, few known manuscripts of the Greek Bible were dated before the 12th century. And many of these copies contained "conflations" (passages that combined differing readings of a text). Sinaiticus and Vaticanus provided scholars with manuscripts up to 800 years older and without conflations. Still, 300 years separated them from the New Testament autographs.

Egypt, however, seemed to offer hope of narrowing that gap. In 1897, excavators in central Egypt found a papyrus scrap from Matthew's Gospel dating about A.D. 200. Other ancient non-biblical documents had come to light there.

Then an exciting discovery brought the oldest manuscripts much closer to the

autographs. The key individuals this time were a devoted scholar and a mining engineer who collected ancient documents.

As director of the British Museum, Sir Frederic Kenyon had devoted his life to the study of biblical manuscripts. (He later championed the museum's purchase of Codex Sinaiticus from Russia.) On November 19, 1931, he announced the discovery of several Old Testament and New Testament manuscripts, dated from A.D. 200 to 250.

No one knows exactly how the discovery was made. Evidently, sometime in 1930, Alfred Chester Beatty, a wealthy American mining engineer living in London, learned about the texts through Egyptian antiquities dealers.

Beatty purchased portions of 11 codices and had Kenyon evaluate them. They turned out to be parts of nine Old Testament books in Greek and fairly complete portions of 15 New Testament books, including the Gospels, Acts, and Paul's epistles.

Referred to as the Chester Beatty Papyri, their source is unknown. Presumably the dealer had bought the papyri from anonymous but enterprising finders who had located them in the ruins of an ancient Coptic monastery library, church, or graveyard in central Egypt.

The discoverers were clever; no sooner had Beatty made his purchase and Kenyon his evaluation than similar but smaller codices turned up at several universities. Apparently the finders sold parts of their discovery to different buyers to increase their profit.

In any case, this discovery provided sources that dated at least a century earlier than previously discovered manuscripts. The papyrus copy of Paul's letters (called P<sup>66</sup>) apparently was made only 140 years after he wrote them.

Furthermore, these papyri suggest that Sinaiticus and Vaticanus might not be direct copies — or even copies of early copies — of the original autographs. The papyri have several textual readings that differ from them, yet might have been in the autographs.

Sinaiticus and Vaticanus, therefore, might simply be texts carefully compiled from several good manuscripts. In any case, Bible readers owe much to those unknown Egyptian treasure hunters.

### Treasure in Earthen Vessels

We owe a similar due to the Ta'amireh tribe of bedouin in Palestine. For three centuries its herds have roamed the barren cliffs above the Dead Sea's western shore (the biblical "wilderness of Ju-

dah"). But in 1947, an amazing accident transformed this wasteland into a gold mine. The hero was a Ta'amireh shepherd boy.

Oddly enough, early writers seemed to know that scrolls had been stored in that area. Fourth century church historian Eusebius reported that Origen, a brilliant Christian scholar from the third century, used a Greek text of Psalms found with other Hebrew and Greek books about A.D. 200 in a jar near Jericho. In A.D. 800, Timotheus I, patriarch of the Nestorian church, described how a bedouin shepherd found many Hebrew manuscripts in a cave near there. And in a history of Jewish sects (A.D. 937), another writer mentions "the cave people," a sect from the first century B.C. whose books were found in a cave.

Scholars certainly needed earlier Old Testament Hebrew manuscripts. The earliest one available, the Nash Papyrus (about 150 B.C.), contained only Deuteronomy 6:4-6 and the Ten Commandments. The earliest complete Old Testament, the "Masoretic text," came from the ninth century A.D., almost 1,300 years after Malachi.

Greek translations like Sinaiticus and Vaticanus provided an indirect glimpse of the Hebrew original, but scholars could only guess what Hebrew words lay behind the Greek.

In the spring of 1947, a young shepherd named Muhammad adh-Dhib was pasturing his herd above the Dead Sea near Bethlehem when a runaway goat slipped into one of the many caves that dot the area. Perhaps to flush out the stray, he threw a stone inside. Instead of the expected "thud" and wounded "baa," the sound of shattering pottery echoed inside. Frightened, the boy fled.

Later Dhib returned with a friend and crawled into the cave. They found eight jars containing large leather scrolls wrapped in linen. The Ta'amireh tribe had long moonlighted by selling ancient artifacts. So the two tried to sell the scrolls in Bethlehem.

There are conflicting accounts of what happened next, but three of the "Dead Sea Scrolls" were finally sold to Professor E.L. Sukenik of the Hebrew University in Jerusalem and five to Metropolitan Samuel of St. Mark's Syrian Orthodox Monastery, also in Jerusalem. The Jewish-Arab conflict, which separated east and west Jerusalem, kept them in the dark about each other's purchase.

Between 1948 and 1951, most of the original Dead Sea Scrolls were published. In 1954, Sukenik's son, famous

## The Quest for the Original Bible (5 of 5)

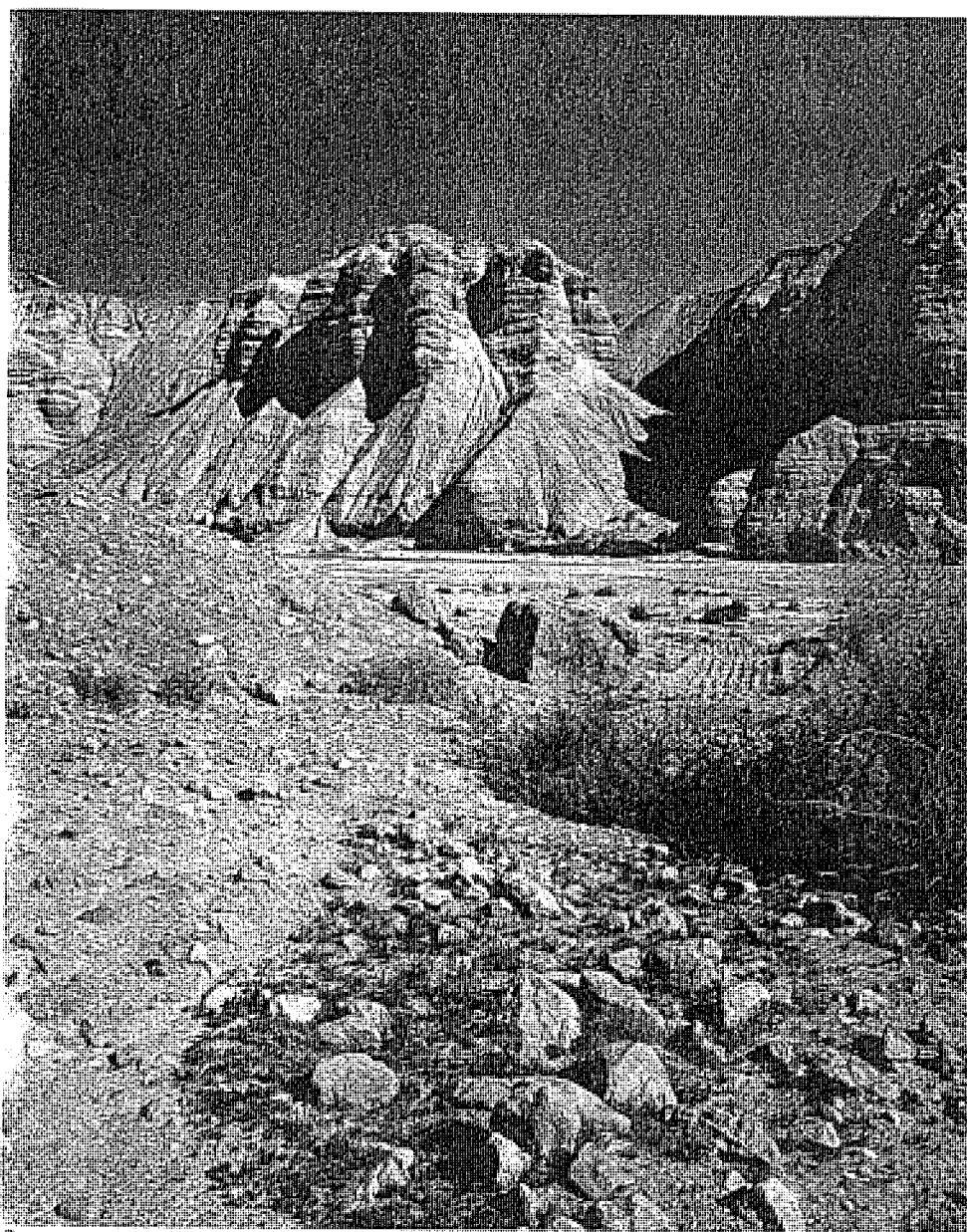

**Qumran caves: the Essenes' desert repository for hundreds of biblical manuscripts**

archaeologist Yigael Yadin, bought the Metropolitan's scrolls for \$250,000. Thus, all the first scrolls now belong to Israel, where several are on display in the "Shrine of the Book" in Jerusalem.

The contents of these scrolls proved astounding. They contained two Hebrew texts — part of Isaiah and a commentary on Habakkuk chapters 1 and 2. Their script and writing style date to the first two centuries B.C. Excavation of Cave 1 (in 1949) and of ancient ruins a half mile away (from 1951 to 1956) shed light on their origin.

The site, called Qumran, was the monastery of the Essenes, an ancient Jewish religious sect. A stone writing desk and two inkwells linked the sect to the scrolls. Dated coins and pottery indicate the community existed from about 100 B.C. to A.D. 68, when the Romans destroyed it.

Apparently the Essenes hid their precious scrolls in caves shortly before the Roman destruction.

After the find, archaeologists and bedouin competed in exploring hundreds of other nearby caves. Most often, the patient bedouin got the upper hand — and profited handsomely.

Eleven caves produced at least 400 biblical manuscripts. Cave 4 was especially significant. It yielded, in one scholar's words, "the ultimate in jigsaw puzzles" — thousands of scraps from 90 biblical manuscripts. Among them were parts of every Old Testament book except Esther.

In the search, the Ta'amireh also found manuscripts in caves 11 miles south of Qumran, at Wadi Murabba'at. These include letters from Bar Kokhba, leader of the second Jewish revolt (A.D. 132-135), a

scroll of the Minor Prophets, and fragments of four leather scrolls (one each of Genesis and Deuteronomy, and two of Exodus).

The importance of the Dead Sea Scrolls cannot be understated. The very number of manuscripts is extraordinary. More important, they provide scholars with Hebrew manuscripts 1,000 years older than any previously known.

Furthermore, they clarify the meaning of some Hebrew words in the Old Testament. For example, no one knew the meaning of the last word in Isaiah 14:4. Scholars suspected it was a misspelling of the word "fury," that a scribe miscopied a "d" for an "r," as those Hebrew characters are similar. The Qumran scroll of Isaiah confirmed that suspicion; it clearly has "fury."

Finally, the scrolls show that both the Septuagint (such as Sinaiticus and Vaticanus) and the Samaritan Pentateuch (the Samaritan sect's Bible; see John 4) have an ancient and accurate Hebrew text behind them. This confirms their value for textual study. In some passages, their text may be even closer to the autograph than the Masoretic text.

#### The Quest's Testimony

The accounts of Tischendorf and others testify to God's providential care of his Word. He

preserved it on a monk's shelf, in a church library, a pile of ruins, and a dusty cave.

Did the persistent Tischendorf spot the wastebasket clue as a result of luck? Was it by chance that the young shepherd's stone struck the jar? No, these discoveries also bear witness to God's providential guidance and gracious provision.

Granted, the cast of characters was imperfect. It included both the determined Tischendorf and the profiteering bedouin. Shady antiquities dealers and midnight grave robbers played a role.

Yet like the brutal Babylonians (Hab. 1,2) or the noble Ezra, they carried out a divine mission. Through them, God has provided his people with ancient copies of Scripture that reassure us the Bible we read today is what he intended to say through the prophets and apostles. ■



# Old Testament Book Studies

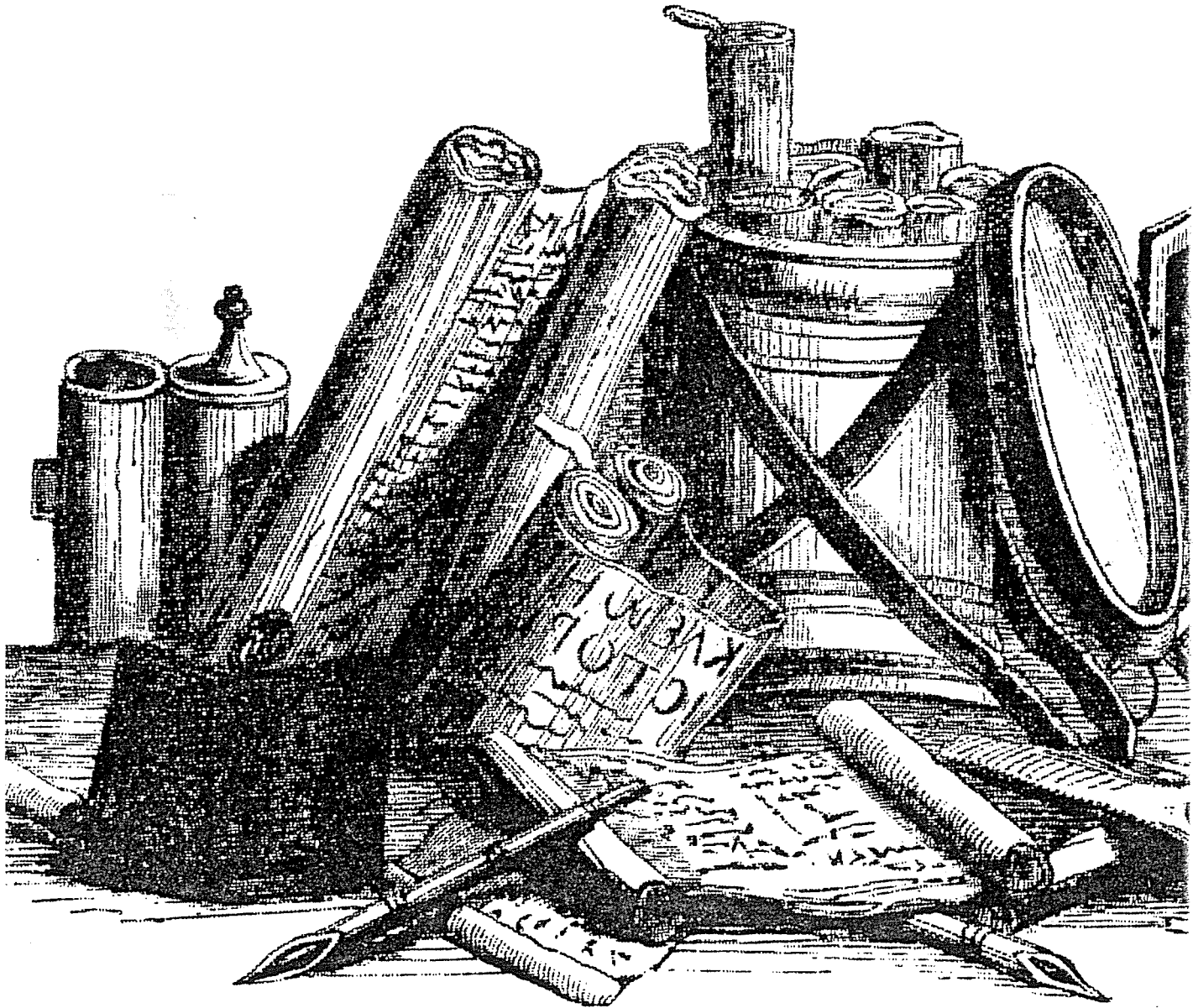



# The Pentateuch

The Bible Visual Resource Book, 11

## Books of Law

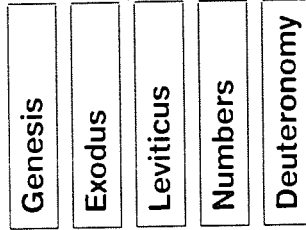

The five books of the Law are also called "the Pentateuch," which means "five scrolls." At least some of this ancient literature was written by Moses (Luke 24:27, John 5:46). These books describe the creation of the world, God's call to the Hebrews to be His special people, their captivity and release from Egypt, the laws which guided them on their way to the Promised Land and how God blessed the people when they obeyed and disciplined them when they disobeyed.

### When Events Happened

Timeline of Events:

- 2000 BC: IN THE BEGINNING GOD CREATED THE HEAVEN AND EARTH
- FLOOD
- BABEL
- ABRAHAM (2100 BC)
- ISAAC
- JACOB (1900)
- JOSEPH (1800)
- MOSES (1600 BC)
- 1450 BC
- 1400 BC
- JOSHUA, CALEB
- MOSES, JOSHUA

# Introduction to the Pentateuch

HISTORICAL	POETICAL	PROPHETICAL
Genesis Exodus Leviticus Numbers Deuteronomy	Job Psalms Proverbs Ecclesiastes Song of Solomon	Isaiah Jeremiah Lamentation Ezekiel Daniel
Joshua Judges Ruth 1 Samuel 2 Samuel 1 Kings 2 Kings 1 Chronicles 2 Chronicles		Hosea Joel Amos Obadiah Jonah Micah Nahum Habakkuk Zephaniah
Ezra Nehemiah Esther		Haggai Zechariah Malachi

The Old Testament chronicles the creation of man and the institution and development of Israel as the nation of God. Although man was created perfect, he spurned God's will and rebelled. The rest of Scripture records the selfless efforts of God to restore man to his potential.

The story of this relationship of God with man begins in the first five books of the Old Testament, called the Pentateuch. The term "Pentateuch" is derived from two Greek words, *penta*, meaning five, and *teuchos*, meaning volume or scroll. It means then, five scrolls or five volumes and refers to the first five books of the Old Testament written by Moses. Genesis through Deuteronomy transports us through centuries of God's program by recording primarily the creation, the fall, the flood, the tower of Babel, the call of Abraham, the rise of the nation of Israel, the bondage in Egypt, the exodus from Egypt, the wilderness wanderings, and the preparations for re-entering the Promised Land.

This story, however, is found in only three of the five books of the Pentateuch: Genesis, Exodus and Numbers. Genesis slices neatly into two parts. Chapters 1-11 record four major events: the creation of man, the fall, the flood, and the tower of Babel. Chapters 12-50 highlight four major men: Abraham, Isaac, Jacob, and Joseph. The book of Exodus depicts the nation of Israel in bondage in Egypt. God sovereignly hand-picks Moses to lead Israel out of bondage in Egypt and start them on their journey back to the Promised Land. The book of Leviticus is written immediately after the close of Exodus. It records primarily the regulations governing the offerings of the Priesthood and the feasts which the nation was to observe annually. Numbers depicts the wandering of the children of Israel in the wilderness after their refusal to enter the land at Kadesh-Barnea. At the end of this period of wandering Moses leads them to the top of the Dead Sea where he preaches three long sermons, turns the responsibility for leadership over to Joshua, and dies. Deuteronomy records the three sermons of Moses before his death. Like Leviticus, Deuteronomy does not advance the movement of the children of Israel toward the Promised Land.

In observing the relationships between the books of the Pentateuch, it becomes clear that they fit together like "hand and glove." Genesis pictures the *inception* of the nation of Israel beginning with its father, Abraham. Exodus portrays the *redemption* of that nation from bondage in Egypt under the leadership of Moses. Leviticus describes the *fellowship* that God desired to enjoy with the nation, centering around the Levitical priesthood and the series of offerings. The central figure in this picture is the high priest Aaron. The book of Numbers records God's *testing* of the nation of Israel under the guidance of Moses. And Deuteronomy chronicles the *reiteration* of the Law of God to the second generation of Israelites under first Moses, then Joshua.

## Contrasting Books of the Pentateuch

Bruce Wilkinson and Kenneth Boa, *Talk Thru the Bible* (Nashville: Nelson, 1983), 3

“The five books of Moses are variously known as the Law, the Torah (Hebrew for Law), the Law of Moses, the ‘five-fifths of the Law,’ and the Pentateuch. The word ‘Pentateuch’ is derived from the Greek words penta (five) and teuchos (scroll or book).

“Although there is much external and internal evidence that supports the Mosaic authorship of these five books, many critics in the last two centuries have challenged this. The usual scenario is that Israel’s religion evolved through several stages and various literary strands appeared along the way. These were edited during the divided kingdom and after the Babylonian Exile. These theories, however, are built upon assumptions that have since been proven false or remain unproven.

“Is the Pentateuch Mosaic or is it a mosaic? These books show a clear continuity of content, theme, purpose, and style that point to a single author. They make up a unity, not a late and unreliable patchwork. Each book smoothly picks up where the previous book left off. There is a completeness about the Pentateuch not only in its consecutive history but also in its progressive spiritual development.”

Book	Key Idea	The Nation	The People	God's Character	God's Role	God's Command
Genesis	Beginnings	Chosen	Prepared	Powerful Sovereign	Creator	“Let there be!”
Exodus	Redemption	Delivered	Redeemed	Merciful	Deliverer	“Let My people go!”
Leviticus	Worship	Set Apart	Taught	Holy	Sanctifier	“Be holy!”
Numbers	Wandering	Directed	Tested	Just	Sustainer	“Go in!”
Deuteronomy	Renewed Covenant	Made Ready	Retaught	Loving Lord	Rewarder	“Obey!”

# Genesis

<b>Origin in Election and Promise</b>										
Creation	Fall	Flood	Babel	Abraham	Isaac	Jacob	Joseph			
<b>Primeval Events</b>						<b>Patriarchal Characters</b>				
1:1–11:26						11:27–50:26				
<b>God’s Election</b>						<b>God’s Promise</b>				
<b>Adam and Descendants</b>						<b>Abraham and Descendants</b>				
1/5 of Genesis						4/5 of Genesis				
<b>Mesopotamia</b>						<b>Canaan</b>			<b>Egypt</b>	
2083 years (4143-2060 BC)						215 years (2060-1845 BC)			71 years (1845-1774 BC)	
The tôledôt of...	Heavens & earth	Adam	Noah	Sons of Noah	Shem	Terah	Ishmael	Isaac	Esau	Jacob
Creation	Post-Creation	Sons of Adam	Noah	Sons of Noah	Sons of Shem	Abraham & Isaac	Sons of Ishmael	Jacob	Sons of Esau	Joseph
1:1–2:3	2:4–4:26	5:1–6:8	6:9–9:29	10:1–11:9	11:10–26	11:27–25:11	25:12-18	25:19–35:29	36:1–37:1	37:2–50:26
Covers 2369 Years of History										
Written During Wilderness Wanderings (c. 1405 BC)										

**Key Word:** Election

**Key Verse:** “I will bless you...and all peoples on earth will be blessed through you” (Genesis 12:1-3)  
(Remember: Genesis One-Two, One-Two-Three)

**Summary Statement:**

The narrow lineage of Israel from Creation to Joseph informs Israel it began by God’s election for rule and unconditional promise for blessings through Abraham in contrast to the Canaanites.

**Applications:**

1. Creation means we’re people of choice, not chance—election, not evolution. Know who you are!
2. God chose you to bless the world too! Are you a blessing to others?

# Genesis

## Introduction

- I. **Title** The Hebrew title (בְּרֵאשִׁית *Bereshith*) means "in the beginning" (BDB 912a 1a), taken from the first phrase of the book. *Genesis* is a Greek noun (γένεσις *genesis*) meaning "beginning, origin, descent" (BAGD 154d) from the verb (γεννάω *gennao*) meaning to "beget, bear, bring forth, produce, cause" (BAGD 155b). The Greek word *genesis* is translated "generation" in Matthew 1:1. This title is significant since Genesis functions as the book of beginnings that traces man's origins down through the chosen seed.

## II. Authorship

- A. **External Evidence:** Both Scripture and tradition throughout the ages have attributed the authorship of Genesis to Moses. Evidence from tradition includes the early church, the Jerusalem Talmud, and the first-century Jewish historian Josephus (*TTTB*, 6). However, early in the Christian era some theologians vacillated between Moses and Ezra as the author of the entire Pentateuch (Ross, *BKC*, 1:15). Although Genesis does not directly specify its author, the other four books of the Pentateuch affirm Mosaic authorship (cf. Exod. 17:14; 24:4, 7; 34:27; Lev. 1:1-2; Num. 33:2; Deut. 1:1; 31:9). The rest of the Old Testament contains even more explicit references to his authorship of the Pentateuch (cf. Josh. 1:7; 8:32-34; 1 Kings 2:3; 2 Kings 14:6; 21:8; Ezra 6:18; Neh. 13:1; Dan. 9:11-13; Mal. 4:4). The New Testament also subscribes to Mosaic authorship (cf. Matt. 8:4; Mark 12:26; Luke 16:29; John 5:46-57; 7:19; Acts 26:22; Rom. 10:19; 1 Cor. 9:9; 2 Cor. 3:15).

Despite this almost unanimous evidence from Scripture and tradition, modern critical scholars adhere to the Documentary Hypothesis as developed originally by Jean Astruc in 1753 and forcefully developed by Julius Wellhausen in 1877. The theory claims that the Pentateuch is not authored by Moses but is compiled from four sources, represented by the letters J, E, D, and P. The "J" material gives preference to the name "Jehovah" (Yahweh) from 850 BC, "E" emphasizes the Eloheim name from 750 BC, "D" was written by the Deuteronomistic school composed under Hilkiah in 621 BC, and "P" dates from the Priestly Code of Ezra from 570-445 BC (which includes "H," the Holiness Code). The effect is to chop up the Pentateuch into many parts, with many authors, composed at different times.

This JEDP Theory, though widely held today, is fraught with numerous problems. It begins with an antsupernatural base, viewing the Bible as an unreliable human book. No unanimity exists concerning which passages are supposedly from the various sources. It also is subjective, often arguing in circles. Further, modern archaeology has disproved many of its tenants in the discovery of the Ebla, Nuzi and Mari tablets which give evidence for vocabulary and similar literary styles of other patriarchal cultures comparable of those found in the Pentateuch (cf. Ross, *BKC*, 1:15-18 for bibliographic data). While some editorial work may have been done by others under the inspiration of the Holy Spirit, no substantial evidence exists that the Pentateuch was not composed by Moses. To think otherwise is to contradict the clear testimony of both tradition and Scripture.

- B. **Internal Evidence:** The book itself does not name its author. However, no one could have been better qualified than Moses to write the book as "Moses was educated in all the wisdom of the Egyptians" (Acts 7:22) and had the literary skills necessary to compose such a work. Gleason Archer notes, "We have the witness of the incidental allusions to contemporary events or current issues, to social or political conditions, or to matters of climate or geography. When all such factors are fairly and properly weighed, they lead to this conclusion: the author of these books and his readers must originally have lived in Egypt" (*Encyclopedia of Bible Difficulties*, 46). See Archer's book for extensive internal evidence for Mosaic authorship and refutation of the Documentary Hypothesis (*ibid*, 46-54).

### III. Circumstances

- A. Date: Mosaic authorship of Genesis places the writing during his lifetime (1525-1405 BC). It was almost certainly penned in his final forty years during the wilderness wanderings with the other books of the Pentateuch that could not have been composed earlier.
- B. Recipients: Moses died before Israel entered the Promised Land so the original readers comprised the Jews in the wilderness with him.
- C. Occasion: Since Moses knew that he would be passing on while the nation of Israel continued for generations, he wisely (and under the direction of the Spirit) put down in writing the history of the birth of the Jewish nation. The purpose Moses wrote it was to trace the lineage of Israel in a narrowing process from Adam, especially as the race deteriorated and accumulated cursings until the promise of blessing began with Abraham and the Jewish nation (12:1-3).

### IV. Characteristics

- A. Genesis is unique among the biblical books in that it records the beginning of everything except God (*TTTB*, 7): the universe (1:1), man (1:27), the Sabbath (2:2-3), marriage (2:22-24), sin (3:1-7), sacrifice and salvation (3:15, 21), the family (4:1-15), civilization (4:16-21), government (9:1-6), nations (11), and Israel itself (12:1-3).
- B. Genesis spans more time than any other book of the Bible (Creation in 4143 BC to Joseph's death in 1774 BC amounts to 2369 years!). In fact, it covers more time than all of the other sixty-five books combined (*TTTB*, 7)! For verification of these dates see the handouts "Chronology of the Patriarchs" and "Timeline of the Patriarchs" (pp. 85-90).
- C. A very popular argument against the historicity of Genesis 1–11 goes like this: "The first eleven chapters of Genesis were not meant to be taken as history. They are stories which reveal truths which are deeper than a mere record of what took place."

Reaction to the Statement: Several facts show the fallacy of such a statement:

1. One must ask what the writer intends by the word "deeper." What could be more "deep" than an understanding of first the *literal* truths, then the *implications* of those truths?
2. This approach to Genesis 1–11 is dangerously subjective. Without an historical basis these so-called "revealed truths" become not scriptural truths but those of one's own making.
3. This statement that interpreting a passage literally sees only a "mere record of what took place" totally ignores the immensity of vital information contained in these eleven chapters. Genesis 1–11 records some of the most important events of history, and even the beginning of history itself. These events include the origin of nearly everything except God: the earth, the heavens, animal life, plant life, man, woman, marriage, family, sin, death, the nations, etc. Without the information recorded in these chapters, one's view of such origins is wholly inadequate. Further, those who do not accept them at face value rarely provide an alternate explanation of the origin of these things.
4. The above statement also ignores the place these chapters play in the argument of the Book of Genesis (see purpose below).
5. The historicity of these events is confirmed through several factors:
  - a. The events are presented as historical by using literal names of people, geographical locations, and specific events (conversations, actions, etc.). No indication within their pages even hints that they are not historical. To accuse Moses of fiction presented in this form is to accuse him of deliberate deception.

- b. Science confirms the historical record found in Genesis 1–11. The order of creation (ch. 1) is that which is required by science (as contrasted with the *theory* of evolution). Modern scientific studies also validate the record of a universal flood in chapters 6–9. The only alternative to the historicity of this section of Genesis is the unacceptable theory of evolution. See the pages at the end of this study on Genesis for more details, including a biblical view of dinosaurs.
- c. The best testimony to the historicity of these events is Christ Himself. He affirmed Adam and Eve as the original first married couple in His quotation of Genesis 2:24 to the Pharisees who had questioned him regarding the legitimacy of divorce (Matt. 19:1ff.). Certainly if Jesus upheld the historicity of Genesis 1–11 then there can be no doubt as to its historical nature.

Purpose of Genesis 1–11: The Book of Genesis records Israel's origin in election (chs. 1–11) and promise (chs. 12–50). This first major section (chs. 1–11) chronicles the election of a seed (ultimately Shem's) amidst the deterioration of the race so that God could mercifully save man through Abraham. This deterioration and election finds support in the repeated phrase "the generations of..." (i.e., "this is the succession from..." cf. NIV) in the Book of Genesis. The following outline of chapters 1–11 follows this structural marker:

1:1–2:3	The account of creation
2:4–4:26	The generations following the creation
5:1–6:8	The generations of Adam
6:9–9:29	The generations of Noah
10:1–11:9	The generations of the sons of Noah
11:10–26	The generations of Shem

In each case God's faithful narrowing of the lineage of blessing can be observed, despite the unfaithfulness of mankind even to the point that God needs to start again with Noah. Without an historical perspective of this section it is useless to speak of the election of a seed culminating in Israel as His chosen nation to bring blessing to the world (cf. Gen. 12:1-3).

- D. Genesis is also unique in that it introduces the Abrahamic Covenant which is foundational to understanding the other biblical covenants and Israel's future.

The Nature of the Covenant:

1. The eternal nature of the Abrahamic Covenant is evident in God's commitment to give Abraham a land as an "everlasting possession" (Gen. 17:8) which itself is part of an "everlasting covenant" (Gen. 17:7).
2. The literal nature of the covenant must be upheld if one employs the normal meaning of language. The promise is a literal seed (descendants) to a literal man who traveled to a literal place that God promised.
3. The application of the covenant includes the promises to Abraham, his physical descendants, and all the earth (i.e., Gentiles).
  - a) *Personal promises* to Abraham were fulfilled in the provision of Isaac as the seed promised from his own body (Gen. 15:1-9), the material blessings he enjoyed, the revered name he had, and the divine discipline of those who opposed him.
  - b) *National promises* to Abraham's seed include the future fulfillment of three related covenants that are unconditionally promised to Israel (see below on the nature of the Palestinian, Davidic, and New Covenants).
  - c) *Universal promises* to the entire world are seen in "all nations will be blessed because of you" (Gen. 12:3). This blessing is for Gentiles as well as Jews by faith in Christ, who is Abraham's seed. Also, at the fulfillment of the Abrahamic Covenant the entire world will benefit.

- 4) The unconditional nature of the Abrahamic Covenant is evident in several texts:
- As already noted, the covenant is eternal (Gen. 17:8). It naturally follows that since nothing can prevent the covenant from its eternal ramifications, then the covenant must be unconditional too.
  - No conditions are ever expressed in relation to the covenant (unless one includes the need for Abraham to leave Mesopotamia, which is fulfilled). The repeated use of the formula "I will" on the part of God at the institution of the covenant points to its unconditional nature.
  - God never withdrew His covenant promise despite the many acts of disobedience on the part of Abraham and the nation. Abraham's sojourn and deception in Egypt recorded in Genesis 12:10-20 never made void God's promise, nor did any other action on his part or of his descendants.
  - The sacrificial ritual detailed in Genesis 15:7-18 also confirms the unconditional nature of the Abrahamic Covenant. The normal practice in Mesopotamia (the place of Abraham's birth) was that when two parties desired to enter into a covenant they would sacrifice an animal, separate it into two pieces, and walk together through the pieces. This act signified an invoking of the same fate upon either of them should they break the treaty. God commanded Abraham to sacrifice and cut up and separate not one, but *five* animals (heifer, goat, ram, pigeon, and dove), thus showing the importance of the covenant. No doubt Abraham expected that somehow he and God (in some form) would walk through the pieces together; however, God caused him to fall into a deep sleep so that he could not participate in the ceremony even if he wanted to do so, then God alone in the form of a burning pot traveled through the pieces. Thus, God bound Himself to fulfill the Abrahamic Covenant apart from any action on Abraham's part.
  - Israel is also promised eternal existence as a nation (Jer. 31:37), which indicates the unconditional nature of the Abrahamic Covenant upon which the nation is founded.

NOTE: Even though the covenant itself is unconditional in that God will definitely fulfill it, participation in this fulfillment is conditioned on an individual basis by belief. Only those who trust in Jesus Christ as Messiah will experience the blessings of this covenant.

The Relationship of the Covenant to the Future: The Abrahamic Covenant also has features expanded upon in three other covenants given to the nation of Israel. These covenants also are unconditional and thus will be fulfilled in the future millennial time of blessing for the nation (see also p. 21).

### Four Unconditional Biblical Covenants

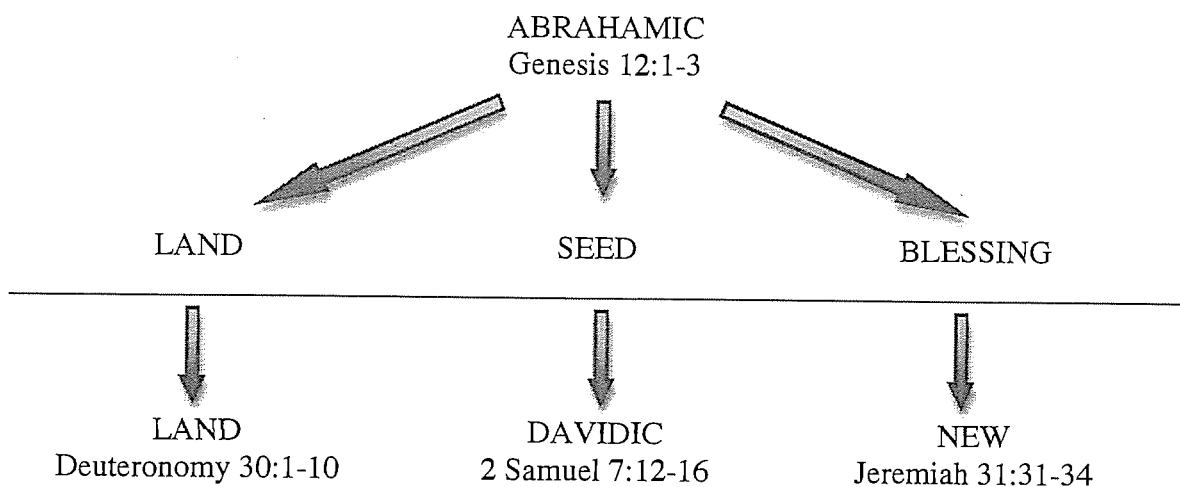

Adapted from Robert P. Lightner, *Last Days Handbook*, 77



- 1) The Land Covenant amplifies the geographical promises of the Abrahamic Covenant, in which God promised to give Abraham a land forever (Gen. 17:7-8). This Land Covenant is declared most specifically in Deuteronomy 30:1-10, where Moses states that after Israel's exile the nation will at one time own the entire land. Never has the nation owned the breadth of territory described in the Land Covenant from the River of Egypt to the Euphrates River (Gen. 15:18), despite amillennial claims that this was the case under Solomon (cf. 1 Kings 4:21). However, although the promise is unconditional, the blessings associated with this promise are contingent upon belief. Moses stated that "when" the nation believed (Deut. 30:1, 2), only "then" (v. 3) would the Land Covenant be in effect practically. In that the post-exilic land prophecy of Zechariah 10:10 looks to a *still future time* of fulfillment, this promise remains future for Israel contingent upon belief in Messiah. After the salvation of the nation (Rom. 11:26-27), the promise will be in effect in the millennial kingdom since it is an eternal covenant (Ezek. 16:60).
- 2) The Davidic Covenant also finds its source in the Abrahamic Covenant and is a further expansion of the original seed promise to Abraham. God's promise of a seed to Abraham (Gen. 12:1-3) from his own body (Gen. 15:1-9) to become a great nation is further explained in His promise to David (2 Sam. 7:10-16). The Davidic Covenant guarantees David that each king who will sit on the throne of Israel will be one of his direct descendants. Moreover, this covenant is declared to be eternal (v. 16) and as such it guarantees Israel that in the future a descendant of David's will again occupy the throne in the kingdom.
- 3) The New Covenant is the third covenant to amplify a feature of the Abrahamic Covenant. In this case it is the "blessing" guarantee that in Abraham "all nations of the earth shall be blessed" (Gen. 12:3). This blessing, of course, comes through the Messiah, Jesus Christ, who is of Abraham's seed. In fact, He is *the* seed (Gal. 3:16). Jeremiah 31:31-34 provides the most explicit statement of the New Covenant. It assures the reuniting of the nations of Judah and Israel with a new heart, forgiveness of sin, and an economy in which no one will need to say "know the Lord, for they all will know Me, from least of them to the greatest" (v. 34). While Christ inaugurated the New Covenant in His blood (Luke 22:20; 1 Cor. 11:25) and thus has allowed Church participation in some of its blessings, presently not all Israel knows the Lord with a new heart and the indwelling of the Spirit. Thus, the complete fulfillment of this amplification of the Abrahamic Covenant still awaits the future salvation of Israel (Rom. 11:26-27).

## Argument

Nearly all scholars agree that the Book of Genesis breaks naturally into two major divisions, roughly chapters 1–11 and 12–50. Within these divisions are eleven sections each beginning with the formula, "the generations of..." (NASB) or "the account of..." (NIV). The first division traces primeval history beginning in creation and culminating with Terah, Abraham's father (1:1–11:26). Although God created everything good (1:1–2:3), the next section reveals man's creation, fall and expansion of sin in his descendants to chronicle the deterioration of the race and thus the need for a Redeemer (2:4–4:26). Four more successions follow in the "This is the account of..." formula which trace the descendants of Adam (5:1–6:8), Noah (6:9–9:29), Noah's sons (10:1–11:9), and Shem (11:10-26). The purpose of these accounts is to inform Israel of God's election of a seed with which He can fellowship and rule.

At 11:27 the book takes a sharp turn. Rather than primeval history, patriarchal history from Abraham to Joseph is recorded to introduce Israel to its origin and preservation as a nation of covenantal promise (11:27–50:26). This occurs primarily through the accounts of the successions from Terah in Abraham's life (11:27–25:11), from Isaac in Jacob's life (25:19–35:29), and from Jacob in the account of Joseph (37:2–50:26). The intervening sections record what became of the descendants of Ishmael (25:12-18) and Esau (36:1-8 and 36:9–37:1). This latter major division in Genesis also traces the deterioration and narrowing of the lineage of Israel, but specifically details how God preserved the nation to fulfill His promise to Abraham of a seed which will bring blessing back to the entire world.

Genesis shows not only Israel's national election, but how God chose *individuals* in His sovereign plan. Note in the argument the *repeated election of the younger over the older* (the older serves the younger; cf. p. 91):

<u>Older</u>	<u>serves the</u>	<u>Younger</u>	<u>References</u>
Nahor		Abraham	11:27-28
Ishmael		Isaac	21:10-12
Esau		Jacob	25:29-34; 27:27-29, 38-40
Reuben, etc. (10 older brothers)		Joseph	37:5-11
Manasseh		Ephraim	48:13-14, 17-20
Reuben, Simeon, Levi (3 older brothers)		Judah	49:8-12

## Synthesis

### Origin in election and promise

#### 1:1—11:26

#### Primeval: God's election

1:1—2:3	Creation	
1:1-2	Title/Pre-creation state	
1:3-31	Creation	
2:1-3	Rest	
2:4—4:26	∞ Post creation	∞ = "the generations of..."
2:4-25	Fellowship	
3	Fall	
4	Death introduced	
5:1—6:8	∞ Adam	
5	Death genealogy	
6:1-8	Sons of God	
6:9—9:29	∞ Noah	
6:9—8:19	Flood	
8:20—9:17	Covenant	
9:18-29	Curse	
10:1—11:9	∞ Sons of Noah	
10	Table of Nations	
11:1-9	Confusion/dispersion	
11:10-26	∞ Shem	

#### 11:27—50:26

#### Patriarchal: God's promise

11:27—25:11	Abraham/Isaac (∞ Terah)
11:27-32	Genealogical data
12—15	Abrahamic Covenant (land)
12	Initiation/threat
13—14	Separation/rescue
15	Ratification
16:1—22:19	Isaac and testing (seed)
16	Threat—Carnal plan (Hagar/Ishmael)
17	Circumcision
18:1-15	Sarah's doubt
18:16-33	Abraham's intercession
19	Lot
20	Threat—Abimelech
21:1-21	Isaac
21:22-34	Seed back in the land
22:1-19	Test
22:20—25:11	Promise transferred to Isaac (Abraham dies)
22:20-24	Rebekah genealogy
23	Land: Machpelah purchase
24	Seed: Rebekah
25:1-11	Dominion: Other sons dismissed

25:12-18	∞ Ishmael
25:19–35:29	Jacob and Esau (∞ Isaac)
25:19–28:22	Promise transferred to Jacob
25:19-34	Blessing forfeited
26:1-33	Covenant transfer
26:34-35	Esau's intermarriage
27:1-40	Blessing manipulated
27:41–28:9	Dominion lost (flees)
28:10-22	Bethel
29–32	Jacob in Haran
29–30	Fertility-family/flocks
31–32	Flees, prepares, wrestles
33–35	Jacob in Canaan (Isaac dies)
33	Reconciliation
34	Shechem
35:1-15	Bethel
35:16-29	Deaths
36:1–37:1	∞ Esau (36:1) and ∞ Esau in Seir (36:9)
37:2–50:26	Joseph (∞ Jacob)
37:2–38:30	Corruption of Joseph's family
37:2-36	Election but enslavement
38	Judah intermarriage/Tamar
39–41	Joseph's exaltation in Egypt
39	Potiphar
40	Prison
41	Pharaoh
42–50	Salvation of Jacob's family (Jacob/Joseph die)
42:1–47:27	Tests–Move
47:28–50:26	Faithfulness of Jacob/Joseph

## Outline

### Summary Statement for the Book

The narrow lineage of Israel from Creation to Joseph informs Israel it began by God's election for rule and unconditional promise for blessings through Abraham in contrast to the Canaanites.

- I. (1:1–11:26) Primeval History: The deterioration and narrowing of the lineage of Israel in the generations from Creation to Terah teaches Israel that God elected a seed with which He can fellowship in contrast to Canaan's powerless deities.
  - A. (1:1–2:3) The Creation portrays God as the Creator of all life so that Israel might know that, as the sovereign LORD of the universe in contrast to Canaan's impotent deities, the God who elected Israel can elect whom He chooses and to show the importance of the Sabbath.
    1. (1:1-2) The introduction to the Creation account portrays God as the Creator of everything and describes the chaotic condition of the earth when God began the first day of His creative work so Israel may see God's power in contrast to powerless Canaanite deities.
      - a. (1:1) The title of the Creation account portrays God as the Founder and Creator of everything at the beginning of the universe.
      - b. (1:2) At the start of God's creative activity the world is described as in a chaotic state to provide an outline for God's activity of bringing form and fullness to His creation.
    2. (1:3-31) The six days of creation recount the origin of all living things (except angels and God) by God's spoken word alone to show Israelites that their God is LORD (sovereign king) of the universe in contrast to powerless Canaanite deities.

Genesis 1:6-8

The Creative Days of Genesis			
DAY	FORMING	DAY	FILLING
1	Light	4	Sun, Moon, Stars
2	Firmament	5	Sea Life, Birds
3	Land, Sea, Plants	6	Land Life, Man
"And He rested on the seventh day..."			

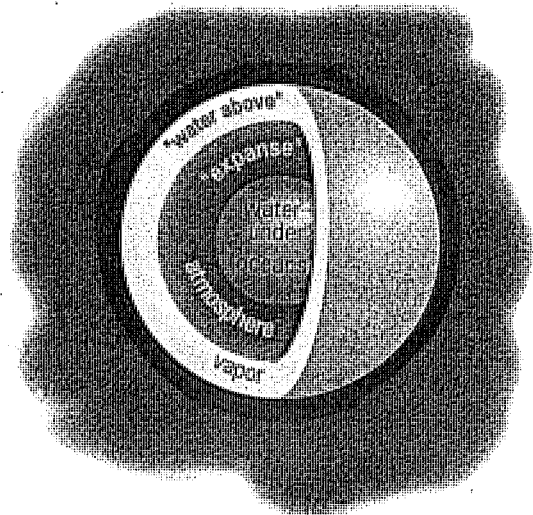

David Egner, *Knowing God Through Genesis* (Grand Rapids: Radio Bible Class, 1991), 9

\* For a summary of differing theories of creation, see page 71.

3. (2:1-3) God's rest and blessing on the seventh day serve as an example of the Sabbath which was instituted under the Law.
- B. (2:4—4:26) The account of what happened after the creation of the heavens and the earth reveals the creation of man, his fall, and the expansion of sin in his descendants to chronicle the deterioration of the race and thus the need for a Redeemer.
1. (2:4-25) The creation of Adam and Eve demonstrates that God created man sinless and in complete fellowship with one another and Himself.
  2. (Ch. 3) The fall of man places responsibility for alienation from God upon Satan and man himself, yet God graciously makes provision for man to get out of this state.
    - a. (3:1-5) Man's temptation shows that Satan has lied from the time of his own fall.
    - b. (3:6-13) The succumbing to the temptation shows that man alone bears responsibility for his alienation from God.
    - c. (3:14-24) The resultant curses of God upon Satan, women, and men is counterbalanced with God's promise of a Redeemer, gracious provision of animal skins, and protection from remaining in his sinful state eternally.

Note: For a helpful article on the meaning of the woman's "desire for her husband" see Susan Foh, "What is the Woman's Desire?" *Westminster Theological Journal* 37 (1974-75): 376-83. Her view that this means that women will want to usurp man's leadership is opposed (unsuccessfully) by Irvin A. Busenitz, "Woman's Desire for Man: Genesis 3:16 Reconsidered," *Grace Theological Journal* 7 (1986): 203-12, who argues that Song of Solomon 1:10 (11) shows that Genesis 3:16 means women will have a "longing for intimacy." For H. Wayne House's review of both articles see *Bibliotheca Sacra* 144 (October-December 1987): 462-63.

3. (Ch. 4) The effects of Adam's sin in Cain's murder of Abel begins to chronicle the deterioration of the race and thus the need for a Redeemer.
- C. (5:1—6:8) The descendants from Adam are traced down to demon-possessed rulers who took harems to indicate how sin results in death to the extent that God needs to start over with one righteous man, Noah.

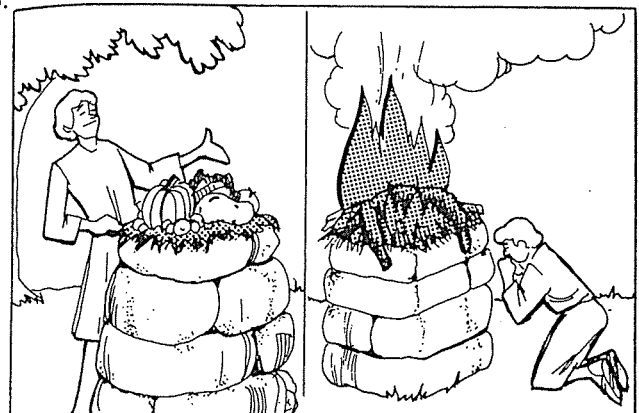

1. (Ch. 5) The genealogy from Adam to Noah indicates how death reigned from sin to demonstrate the need for God to take redemptive action.
2. (6:1-8) The account of demon-possessed rulers who took harems indicates how sin pollutes the race to the extent that God needs to begin the human race again with one righteous man, Noah.

\* For a summary of views on the identity of the “sons of God,” see page 83.

D. (6:9—9:29) The descendants from Noah are traced to his grandson Canaan in the account of the Flood to affirm both God's righteous judgment in response to the downward spiral of man's sin and His gracious redemption in electing a seed with which He can fellowship.

1. (6:9—8:19) God judges the sin of mankind through limiting his age to 120 years through a universal flood to demonstrate His righteous response to the downward spiral of man's sin and gracious redemption in electing a seed with which He can fellowship.
2. (8:20—9:17) God establishes the Noahic Covenant to show that life is sacred and to guarantee that He will never to destroy life again with a flood, which brings in human government to assure order in the world.

The ark was 450 feet long,  
75 feet wide, 45 feet high

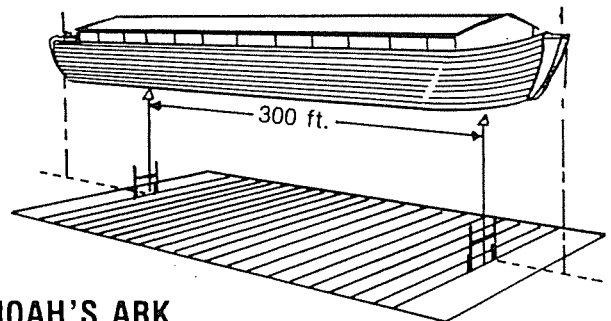

**NOAH'S ARK  
COMPARED TO A FOOTBALL FIELD**

3. (9:18-29) The account of Ham seeing Noah's nakedness demonstrates the sin of even the godly line which curses the Canaanites to demonstrate to Israel the nation's rightful rule of the Promised Land.

E. (10:1—11:9) The descendants from the sons of Noah are traced to the tower of Babel incident to list the line of blessing among the many nations and languages of the earth.

1. (Ch. 10) Seventy descendants from the sons of Noah are traced in the Table of Nations to show both God's judgment on sin through dispersion and God's blessing on the family line of Shem (cf. p. 92).
2. (11:1-9) The tower of Babel incident affirms the baseness of man's hearts and explains that nations and languages resulted from pride, disunity, destruction, and subjugation.

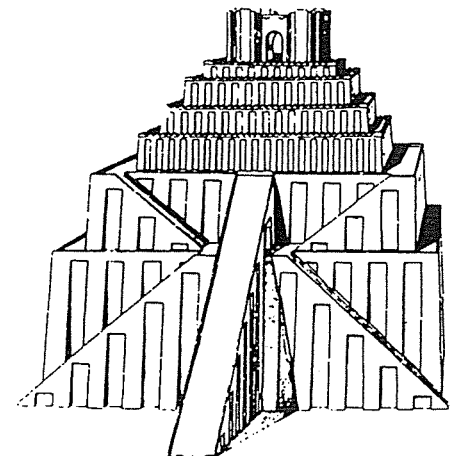

F. (11:10-26) The descendants from Shem are traced to Abram to show divine election through the narrowing of the line of blessing directly to Abraham in preparation for the following patriarchal history which restores blessing from chaos and dispersion.

## II. (11:27—50:26) Patriarchal History: Moses traces the deterioration and narrowing of Israel's lineage from Abraham to Joseph to encourage Israel with its origin and preservation among the heathen as a nation of covenant promise.

- A. (11:27—25:11) The descendants from Terah are traced from Abraham to Isaac in the passing on of God's covenant which promises Abram a land, a nation, and a blessed name, so that Israel might understand its origin as a nation of promise.

1. (11:27-32) An introduction to Abram provides the genealogical data necessary to understand his life (cf. p. 84).
  - a. (11:27-30) Terah has three sons: Abram, Nahor, and Haran, whose son is Lot.
  - b. (11:31-32) Sarai, Abram, Terah, and Lot all travel together to Haran, where Terah dies, thus freeing Abram to trust God fully on his own.
2. (Chs. 12—15) God makes an unconditional covenant with Abram which promises him a land, a nation, and a blessed name, to reveal to Israel God's initiation, separation, and ratification of His covenant.
  - a. (Ch. 12) God's initiation of an unconditional covenant with Abram and the threat to its fulfillment is written to convince Israel of its divine call and need to trust God to inhabit Canaan as did Abram (cf. pp. 59-61).
    - 1) (12:1-9) God initiates a covenant with Abram that promises him a land, nation, and blessed name and Abram goes to a new land in obedience to show Israel of its need to trust God's call to inhabit Canaan as did Abram.
    - 2) (12:10-20) Abram fails to walk by faith in his leaving Canaan for Egypt and lying in an attempt to save his life, yet God mercifully spares him because of His unconditional promise and thus undoes the threat to the promise.
  - b. (Chs. 13—14) Abram separates from Lot and receives confirmation from God regarding his inheritance, then rescues Lot from his enemies and is blessed by Melchizedek to reveal to Israel God's blessing upon faith.
  - c. (Ch. 15) God ratifies His covenant with Abram by promising a son from his own body, prophesying the 400 year Egyptian bondage, and walking alone through the sacrificial animals, to encourage Israel that God's covenant with the nation is unconditional.
3. (16:1—22:19) God provides Isaac, the promised seed, for Abraham and Sarah, whose faith is developed by testing, that Israel might see how God fulfills His promises.
  - a. (Ch. 16) Abram's seeking to secure God's promise of children through a carnal plan that complicates his life is recorded to encourage Israel not to try to accomplish God's will through plans contrary to His will.
  - b. (Ch. 17) God confirms His promise of a seed through Sarah and Abraham (their new names) and gives circumcision as the sign of His covenant so that Israel might understand the theological significance of this circumcision institution.
  - c. (18:1-15) Sarah's faith in God's promise of a son is tested by the LORD and two angels, who state that she will be a mother within a year as a lesson to her and Israel that nothing is too hard for God.
  - d. (18:16-33) Abraham's faith in God's righteous judgment of Sodom is tested by the LORD, who promises not to destroy the city if it has only ten righteous people to verify for Israel that God judges justly.
  - e. (Ch. 19) An interlude in the testing of Abraham and Sarah records the testing of Lot and his wife, who fail God's tests as examples to Israel of the necessity of avoiding sin by a life of faith.
    - 1) (19:1-29) Lot and his daughters escape the destruction of the plain cities of Sodom to record for Israel God's judgment on immoral Canaanites and to warn the nation to avoid similar sins and Lot's wife's sin of worldliness.

- 2) (19:30-38) Lot's incest with his two daughters produces the fathers of two of Israel's enemies, the Moabites and Ammonites, to demonstrate for Israel the long-term effects of sin.
- f. (Ch. 20) Abraham deceives Abimelech about Sarah but God mercifully protects His promise again to teach Israel that participation in His blessings requires separation from the world—especially from adultery and intermarrying pagans.
- g. (21:1-21) Abraham and Sarah's willingness to protect the promised seed is tested through Isaac's birth and Ishmael's rejection to express to Israel the need for removal of hindrances to accepting God's promised blessings.
- h. (21:22-34) Abraham's willingness to live honestly and peacefully in the land is tested in Abimelech's demand for a covenant at Beersheba to remind Israel to keep its oaths and avoid falsehood.
- i. (22:1-19) Abraham's willingness to obey God's word even if it defies logic climaxes in his ultimate test of faith in God's promises through the near sacrifice of Isaac, to teach Israel that faith obeys God without holding back to meet one's own needs.



4. (22:20—25:11) God's transfer of the promise from Abraham to Isaac to teach Israel God's commitment to preserve the covenant seed through the proper family line and the nation's need to trust Him responsibly for the land.
- a. (22:20-24) The genealogy of Rebekah, Abraham's brother's granddaughter and Isaac's future wife, is provided to show that the promise passes in the correct family line and to remind Israel not to intermarry with pagans.
- b. (Ch. 23) After Sarah's death Abraham purchases the cave of Machpelah and buries her there as a renunciation of his Mesopotamian homeland and foretaste of his descendants' occupation of the entire land to give the wandering Israelites hope.
- c. (Ch. 24) God directs Abraham's servant to Rebekah to be Isaac's wife as an example of God's providential working in the lives of His faithful servants to encourage Israel to be faithful, especially to the prohibition of intermarriage.
- d. (25:1-11) Abraham dies after his wife Keturah and his concubines bear him several other sons, but these are sent away to transfer God's promise to Isaac to affirm for Israel its responsibility to carry on God's work.
- B. (25:12-18) The descendants from Ishmael are traced to the twelve tribal leaders who opposed Israel as a reminder to Israel to do God's will in God's way.
- C. (25:19—35:29) The descendants from Isaac are traced in the lives of Esau and Jacob, the latter whom receives God's promise by grace despite his cunning to instruct the nation that God will accomplish His will despite man's scheming.
1. (25:19—28:22) The transfer of the promised blessing from Isaac to Jacob instead of Esau is recorded to teach Israel that it is better to let God accomplish His will through faith rather than man's conniving.
- a. (25:19-34) In fulfillment of prophecy, Jacob purchases the promised blessing from his twin Esau as divine sanction for the promised seed through Jacob and a warning to Israel from sacrificing spiritual blessings for temporal needs.

- b. (26:1-33) God transfers His covenant to Isaac, who enjoys God's blessing despite repetition of Abraham's deception to encourage Israel that God fulfills His promises despite human disobedience.
- c. (26:34-35) Esau's multiple marriages to pagan wives show the foolishness of Isaac's attempt to bless him and serve as an example to Israel that God cannot bless disobedient vessels.
- d. (27:1-40) Jacob manipulates his father's blessing even though God had already promised it, resulting in family disintegration to teach that God's blessings are given by Him, not gained by deceit.
- e. (27:41—28:9) Jacob flees towards Haran for protection from Esau and for a legitimate wife while Esau spitefully marries another pagan wife to instruct Israel in the difficulties of seeking to obtain God's blessings by human effort (cf. p. 94).
- f. (28:10-22) God confirms His promise to Jacob at Bethel and he responds in worship as a pattern of Israel's worship in vows, tithes, and memorials for the future.

The Life of Jacob					
Strife with Family		Conflict with Laban		Struggle with God	
• Stolen Birthright	Journey to Padan Aram	• Marriage	Journey to Canaan	• Wrestles with God	Journey to Egypt
• Stolen Blessing		• Children		• Esau	
		• Prosperity		• Blessing	
Caanan		Haran		Caanan	
77 years		20 years		50 years	
"God's House"		"God's Camp"		"God's Face"	

David Egner, *Knowing God Through Genesis* (Grand Rapids: Radio Bible Class, 1991), 24

- 2. (Chs. 29—32) God blesses and protects Jacob while in Haran totally by His grace yet also disciplines him for marital mistakes and self-sufficiency to teach Israel faith instead of self-effort.
  - a. (Chs. 29—30) God blesses Jacob while in Haran with wives, children, and flocks, but Jacob undergoes God's discipline in marital strife, to provide Israel with the history of the twelve tribes and warn of envy like that of Leah and Rachel.
  - b. (Chs. 31—32) Jacob flees towards Canaan with great possessions and unharmed as proof of divine protection and prosperity but still must meet his formerly offended brother Esau and God Himself, teaching faith instead of self-effort.
    - 1) (Ch. 31) Jacob flees back towards Canaan with great possessions and unharmed as proof of divine protection and prosperity, then promises Laban not to return to Haran to teach Israel of the pain of broken relationships.
    - 2) (32:1-21) Jacob makes preparations to meet Esau with many gifts to instruct Israel in the price to be paid for unreconciled relationships.
    - 3) (32:22-32) Jacob wrestles with God and receives a blessing, has his name changed to Israel, and most importantly, comes away crippled, to teach Israel that faith rather than self-sufficiency is the means to ultimate victory.
- 3. (Chs. 33—35) Jacob returns to Canaan and the promised seed is endangered in the land but protected by the hand of God to remind Israel that God keeps His promises.



- a. (Ch. 33) Jacob is reconciled to Esau which both surprises him and testifies to God's working in Esau's life to encourage Israel with how God changes hearts to protect His promised seed.
  - b. (Ch. 34) The violation of Dinah by Shechem and the deceitful slaughter of the city instructs Israel against intermarriage with pagans, visiting people in the land, and conniving covenants that endanger the promised seed.
  - c. (35:1-15) Jacob returns to Bethel and receives assurance from God that his seed will be protected and made into a great nation in the land to assure Israel that God will indeed keep His covenant promise to Abraham.
  - d. (35:16-29) Jacob experiences transitions in the birth of Benjamin, the deaths of Rachel and Isaac, and Reuben's sacrifice of his inheritance which reaffirm God's protection of His chosen seed that Israel might know that He keeps His promises.
- D. (36:1—37:1) The descendants from Esau are traced to record God's blessing upon him with possessions, chiefs and kings to fulfill His promise and in contrast to Jacob, who waited for the promise, to remind Israel of the priority of spiritual over worldly values.
- 1. (36:1-8) Esau's household through his pagan wives and possessions become so numerous that he moves east to greener land outside of the Promised Land to warn Israel from allowing worldly treasures to supersede spiritual priorities.
  - 2. (36:9-30) Esau's sons and chiefs are traced as evidence of God's blessing in fulfillment of His promise to bless him.
  - 3. (36:31—37:1) Kings from Esau precede Israelite kings while Jacob lives in the land without chiefs, kings, lands, and tribes to remind Israel that worldly greatness may come swifter than spiritual greatness, but the latter demands patience and is worth it.

Joseph's Life		
Prisoner	Benefactor	Brother
37-40	41-45	46-50
Separated from Family	Reunited with Family	Dwells with Family

David Egner, *Knowing God Through Genesis*  
 (Grand Rapids: Radio Bible Class, 1991), 27

- E. (37:2—50:26) The descendants from Jacob are traced in the life of Joseph, whose bondage and deliverance in Egypt serve as a picture of the same for Israel to teach the nation that God's blessing includes suffering as a test of character, requiring faithful response.
- 1. (37:2—38:30) The corruption of Joseph's family through envy and intermarriage highlights for Israel the unconditional nature of the Promise in God's preserving the chosen line through the older serving the younger despite Israel's sin.
    - a. (37:2-36) God elects faithful Joseph to rule but his jealous brothers force him into exile to teach Israel that testing precedes blessing and that no one can thwart God's plan of the older (brothers) serving the younger (Joseph).
    - b. (Ch. 38) Judah's intermarriage with Canaanites and incest with his daughter-in-law Tamar confirms God's protection of the line and immutable plan of selecting the older (Reuben) to serve the younger (Judah).

2. (Chs. 39—41) Joseph's testing and exaltation in Egypt show God's protection of the chosen seed but Israel's need to be faithful as well, despite suffering.
  - a. (Ch. 39) Joseph's refusal of Potiphar's wife reveals his priority of loyalty to God over worldly lusts to teach Israel faithfulness to God despite the suffering that often accompanies righteousness.
  - b. (Ch. 40) Joseph's willingness to interpret the cupbearer and baker's dreams in prison confirms his faith in God not destroyed by circumstances to convey to Israel the importance of faithfulness despite adverse conditions.
  - c. (Ch. 41) Joseph's interpretation of Pharaoh's dreams and rise to power is provided to indicate to Israel God's sovereign control of events to protect His promised seed and the nation's need for faithfulness to serve Him.
3. (Chs. 42—50) The deliverance of Jacob's family by Joseph's exaltation in Egypt shows God's providential dealings to protect and bless the promised seed.
  - a. (42:1—47:27) Jacob's family moves to Egypt after Joseph tests them and reveals himself so that the family would move there in faith and be provided for through Joseph's wise rule to instruct Israel on God's commitment to His promise.
    - 1) (Ch. 42) When Joseph's brothers seek food in Egypt he motivates them to repent from their crime against him by testing them so that his family would move to Egypt in faith and thus participate in God's blessing without evil.
    - 2) (Chs. 43—45) After seeing his brothers' repentance from sinning against him on their second trip to Egypt, Joseph reveals himself so they would move to Egypt only after recognizing God's providential working in their lives.
    - 3) (46:1—47:12) Jacob's entire family moves to Egypt and enjoys the best of the land as God's provision for the promised seed to continue.
    - 4) (47:13-27) Joseph's wise rule gains for Pharaoh all the money, livestock, and land of Egypt as God's blessing for Pharaoh's protection on the seed of Abraham.
  - b. (47:28—50:26) God provides for the continuation of the promised blessing through the faithful actions of Jacob and Joseph to encourage Israel to also express faith in God's promise.
    - 1) (47:28—49:28) Jacob's blessing upon Joseph's and his own twelve sons reveals his submission to God's plan to continue the promised line, especially the older to serve the younger and the Messiah's kingdom through Judah (pp. 91, 97, 171).
    - 2) (49:29—50:14) Jacob's death in Egypt but burial in Canaan indicates his faithful expectation of the land of promise for his descendants to encourage Israel that the land indeed would be theirs.
    - 3) (50:15-21) Joseph reassures his brother's fear of vengeance by reminding them of God's plan to bring the family to Egypt for protection of the promised lineage to encourage Israel to also express faith in God's promise.
    - 4) (50:22-26) Joseph makes his brothers swear to return his bones to Canaan when the family returns home as a sign of his faith in the promise of God, then he dies.

## Does Genesis 1 Teach Literal Days?

### Day-Age Theory Support

The rise of evolution has produced many advocates of the “day-age theory.” This theory teaches that the creation days of Genesis 1 are not in fact 24-hour days, but rather periods of time.

Advocates of the day-age theory are numerous. Many since Philo (*Allegorical Interpretation of Genesis 2–3* 1.2) have followed the day-age view of the six days of creation (e.g., Bush, *Notes on Genesis*, 1:32; E. J. Young, *In the Beginning*, 43; Gleason Archer, *Encyclopedia of Bible Difficulties*, 58-65; Watchtower Bible & Tract Society, *Let God Be True*, 167-70). Both the literal twenty-four hour day view and the day-age perspective acknowledge that the term “day” refers to various lengths of time depending upon context. For brief surveys of the history of the two major theories and their advocates see Davis A. Young, *Christianity and the Age of the Earth*, 11-67, with recent advocates listed on pages 57-59, 63 (day-age/old earth) and 64-65 (literal day/young earth). This book is a thorough and recent defense of the belief that the earth is extremely old (his refutation of the young earth model is summarized on p. 149). Young, himself a creationist geologist, also evaluates scientific (pp. 69-131) and philosophical/apologetic (pp. 133-64) considerations. Biblical concerns are addressed in his book *Creation and the Flood*.

Several points are advocated to support this position:

1. “Day” is used in a non-literal sense in Genesis 2:4: “This is the account of the heavens and the earth when they were created, in the day that the LORD God made earth and heaven” (NASB). In its most literal sense, here “day” is used of a *period* of six 24-hour days. “Day” also refers to 12-hour (not 24-hour) days of sunlight in verses 5, 14, 16, and 18. Other passages use the word “day” in a non-literal sense (Isa. 11:16; BDB 399).

Response: The fact that the term *can* be used in a non-literal way or that it is actually used that way elsewhere does not argue for its use in Genesis 1. The context must be the guide for how to interpret it, so this argument is inconclusive alone. One can see that both the 2:4 reference and the 12-hour uses of “day” appear without a numerical adjective before them, and thus are not parallel uses to the formula “first day... second day, etc.” See the comments on the next page as well.

2. The Sabbath day Israel celebrated was a literal 24-hour day and it found its origin in Genesis 2:1-3, but nothing is said of the length of this day here (no “evening and morning” formula is used). This lack of the formula would argue for a non-literal view of this Sabbath rest.

Response: It is true that the Sabbath-rest of God is not specifically designated as a 24-hour period here. However, this does not argue against a literal view of the days of creation itself. See the study two pages later in these notes.

3. Some days have events that could not have been carried out in a single day’s time. How could the billions of galaxies come about in one day when it takes millions of light years for their light to even reach the earth? How could all of the animals in the world be created in a single day and could Adam even had the time to name them?

Response: This view assumes limitations on an omnipotent God! Also, since God created all the stars at varying lengths of distances from the earth, He must have also created the light beam from them to the earth for our enjoyment. As for Adam naming all the animals in a single day, this could easily have been done for the few hundred species at that time before the thousands of sub-species came into existence.

**Literal (24-Hour Days) Support**

Many others believe in literal 24-hour days in Genesis 1. This seems to me the better view.

For a brief survey of four views on the days in Genesis 1, see page 71 of these notes and John J. Davis, *Paradise to Prison*, 51-57. Davis himself holds to the literal day perspective. Others who advocate six literal days and/or a young earth include John C. Whitcomb, Jr., *The Early Earth*, 26-28; id., *The Origin of the Solar System*, 7-34; Henry Morris, Duane T. Gish, George M. Hillestad, eds., *Creation*, 77-85; H. C. Leupold, *Genesis*, 1:56-58; Gordon Wenham, *Genesis 1-15*, WBC, 19, (but see his pp. 39-40). For a critique of Morris' views see Robert William Prince, III, "An Examination of Henry M. Morris's Interpretation of Biblical Creation," Ph.D. diss., Southwestern Baptist Theological Seminary, 1985.

I also ascribe to this view (as the responses to the arguments on the previous page indicate). What other evidences support a literal 24-hour days in Genesis 1?

1. The Genesis account describes God's creative work as instantaneous. He spoke, and it came into being. This would exclude long, drawn-out processes necessary for creation to occur over centuries. To say that God spoke and then it took millions of years for His word to take effect goes beyond the natural reading of the text.
2. Psalm 33:6, 9 supports the concept of an instantaneous creation: "By the word of the LORD were the heavens made, their starry host by the breath of his mouth." "There is certainly no thought here of delay, or a trial-and-error process, or a gradual, step-by-step fulfillment. In fact, it is quite impossible to image a time interval in the transition from nonexistence to existence!" (Whitcomb, *The Early Earth*, 24-25). While this verse applies to the stars, even when *living things* were created (marine creatures, birds, animals, man), "complex entities appear suddenly, even though built upon preexistent lifeless materials" (ibid., 25).
3. The often repeated formula "there was evening and there was morning—the first [etc.] day" (Gen. 1:3, 8, 13, 19, 23, 31) surely indicates a literal time element, for one cannot have morning without sunrise and evening without sunset. The same phrase appears in Daniel 8:26 (cf. 8:14) in reference to 2300 days. Further, the words for "evening" and "morning" in the OT never refer to long periods of time (Leupold, *Genesis*, 1:56).
4. While "day" is sometimes used in a non-literal sense as pointed out above (Gen. 1:5, 14, 16, 18; 2:4), the use of a numerical adjective ("first," "second," etc.) with the word "day" (*yom*) elsewhere limits this "day" to a literal 24-hour period (cf. Num. 7:11-12, 18, 24, 30, etc.).
5. This creation week sets a pattern for man's work cycle as explained in the fourth commandment (Exod. 20:11; 31:17). As God worked in the daytime for literal 24-hour days, so man works in the daytime and rests at night.
6. The fact that the sun and moon were not created until the fourth day argues for a literal interpretation (1:14-19). If the preceding days were long periods of time (e.g., "morning" and "evening" were each 1000 years), how could plant life sustain itself for centuries without light? However, such is possible in a 24-hour period. The text specifically says that these "lights" were made to govern "days" in the normal sense of the word (1:14, 16, 18).
7. The day-age theory advocates theistic evolution at least to some degree. This has many problems, including the existence of death prior to the Fall in Genesis 3. (See the section on pages 76-79 that critiques theistic evolution.)

## The Length of God's Rest

The nature of God's rest brings up another vital question: Was the seventh day on which He rested a literal twenty-four hour period? The importance of this issue cannot be overstated, for if the seventh day lasted twenty-four hours it gives great weight to the Sabbatarian position. However, if the "day" was not twenty-four hours then the appeal to "God's example" loses much of its force.

Several factors indicate that a literal day is *not* in view in Genesis 2:1-3.<sup>1</sup> First, the repeated formula "and there was evening and there was morning—the first [etc.] day" (Gen. 1:3, 8, 13, 19, 23, 31) is curiously *not* employed in describing the seventh day.<sup>2</sup> This marks this "day" out as distinct from the literal twenty-four hour days preceding it. Deck notes the significance of this fact:

The omission of the formula is no accident. It is surely designed to show that God's "seventh day" of cessation from creative activity *is still running*; it has not closed. It is a 'day' which has now lasted nearly 6,000 years, and will not close until God creates the 'new heavens and the new earth.'<sup>3</sup>

This "indefinite" view of "day" also better explains the nature of God's rest. Certainly the omnipotent God had no need to recuperate from His creative work (Isa. 40:28), so the meaning of His rest is deeper than recovering from physical exertion. The answer is in the text, which explicitly defines God's rest as *ceasing* from the creative work which He did for six days. Dressler correctly observes regarding God's rest and being "refreshed" (Exod. 31:17), "This can only indicate that the goal of creation is not mankind, that the crown of creation is not man, but that all creative activities of God flow into a *universal rest period*."<sup>4</sup>

This finds support in the primary meaning of *shabat* (שָׁבַת), the verb translated as God "rested" but which actually means "to cease" more than "to rest."<sup>5</sup> If God's rest referred to cessation from creative activity for only twenty-four hours, it logically follows that this creative work resumed on the eighth day,<sup>6</sup> a deduction to which no one wants to ascribe. The better alternative is to see God's rest as continuing indefinitely until He begins His creative activity again in crafting a new heaven and a new earth (Rev. 21:1).

---

<sup>1</sup>August Dillmann, *Die Bücher Exodus und Leviticus* (Leipzig: Hirzel, 1880), 90-91, argues that the seventh day "surely cannot be thought of as a day stretching on *in infinitum*" because of the Father's continual work mentioned by Christ in John 5:17. However, Jacob indicates that after God had completed His work "he desisted from it forever" (Benno Jacob, *The First Book of the Bible*, 13; cf. Harold G. Stigers, *A Commentary on Genesis*, 63). The nature and time of God's work is addressed in Richard James Griffith, "The Eschatological Significance of the Sabbath," Th.D. diss., Dallas: Dallas Theological Seminary, 1990, pp. 311-14. There I argue that God's work of *creating* did not continue during the seventh day (age), but His work of *sustaining and healing* does in fact continue. His providential work has lasted through the ages.

<sup>2</sup>Augustine *Confessions* 13.50-51 (chaps. 35-36; ed. Roy Joseph Deferrari, trans. Vernon J. Bourke, 454-55); Franz Delitzsch, *A New Commentary on Genesis*, 1:110; Derek Kidner, *Genesis*, 53; Philip Edgcumbe Hughes, *A Commentary on the Epistle to the Hebrews*, 159.

<sup>3</sup>Norman C. Deck, *The Lord's Day or the Sabbath, Which? A Reply to Seventh Day Adventist Propaganda* (Sydney, Australia: Bridge Printery, n.d.), 21 (emphasis his). Whether God's rest is still running as Deck claims depends upon the effect man's fall had on it, which is addressed later.

<sup>4</sup>Harold H. P. Dressler, "The Sabbath in the Old Testament," in *From Sabbath to Lord's Day: A Biblical, Historical, and Theological Investigation* (ed. D. A. Carson, 21-41; Grand Rapids: Zondervan, 1982), 29 (emphasis mine).

<sup>5</sup>BDB 991d; cf. "Sabbath," *Encyclopedia Judaica*, by Smith, Marti, and Cheyne, 4:4173.

<sup>6</sup>Robert A. Morey, "Is Sunday the Christian Sabbath?" *Baptist Reformation Review* 8 (1979): 6, makes this observation in support of an indefinite seventh day.

One may rightfully ask if the context of Genesis 2:1-3 can support such a view of "day."<sup>7</sup> The answer lies in *the next verse*, which also employs the exact word for "day" (יָמָא) in a non-literal sense: "This is the account of the heavens and the earth when they were created, in the day that the LORD God made earth and heaven" (NASB).

Furthermore, in Genesis 1 "day" is used for the period of light that began with the creation of light on the first creative day (v. 5) which became a period of twelve daylight hours (vv. 14, 16). These parallel, figurative uses do not *confirm* that the "day" of Genesis 2:1-3 denotes a period of time rather than a literal day, but they do suggest the possibility of interpreting "day" in a figurative sense.<sup>8</sup> Taken together, the preceding evidences provide sufficient reason to consider the seventh day as of indefinite duration rather than twenty-four hours long.

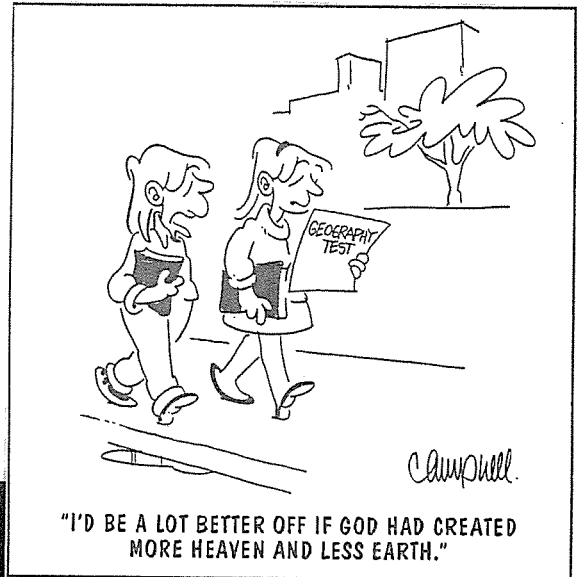

<h2>Evangelicals Differ</h2>	
<p><b>Reasons to Believe</b>                  Hugh Ross                  Walt Brown                  Old Earth                  Day-Age Theory                  Local Flood                  Rain waters</p> <p>reasons.org                  godandscience.org                  creationscience.com</p>	<p><b>Institute for Creation Research</b>                  Henry/John Morris, Duane Gish                  Joseph Dillow, Ken Ham                  Young Earth                  24-hour Creation Days                  Universal Flood                  Vapor canopy</p> <p>answersingenesis.org                  genesispark.org                  icr.org critiques Ross at:                  icr.org/pubs/imp/imp-217.htm</p>

<sup>7</sup>Some support the twenty-four hour perspective of the seventh day based upon the reference to Genesis 2:1-3 in Exodus 20:11; 31:17 and the twenty-four hour usage for the six days of creation (e.g., *Seventh-day Adventist Bible Commentary*, Francis D. Nichol *et al.*, eds., 1:220; C. F. Keil, *The Pentateuch*, K&D, 1:69-70). Skinner also notes that "it is plainly a rest of one day that is thought of" (John Skinner, *A Critical and Exegetical Commentary on Genesis*, 2d ed., International Critical Commentary, eds. Samuel Rolles Driver, Alfred Plummer, and Charles Augustus Briggs [Edinburgh: T. & T. Clark, 1910], p. 38). It is true that Exodus 20:11; 31:17 commands Israel to observe the Sabbath based on God's example of ceasing from His work after six days. Clearly Israel was to rest one day, yet it goes beyond the intent of the passages to claim that God rested a literal day and then resumed creating the heavens and the earth. The fact that God called the creation "good" and "very good" argues that no more creative work was necessary.

<sup>8</sup>Martin Anstey, *The Romance of Biblical Chronology*, 1:63.

# Creation Magazine

Creation Archive > Volume 19 Issue 1 > How long were the days of Genesis 1?

## How long were the days of Genesis 1?

What did God intend us to understand from the words He used?

by Russell Grigg

Were the days of Creation Week of 24 hours duration or were they long periods of time? This article will discuss the Hebrew 'time' words which the author had available to him and what meaning he intended to convey by his choice of the specific words he used.<sup>1</sup>

First published:  
*Creation*  
19(1):23–25  
December 1996

Browse this issue  
Subscribe to  
Creation Magazine



### Meaning of *yôm*

When Moses, under the inspiration of God, compiled the account of creation in Genesis 1, he used the Hebrew word *yôm* for 'day'. He combined *yôm* with numbers ('first day', 'second day', 'third day', etc.) and with the words 'evening and morning', and the first time he employed it he carefully defined the meaning of *yôm* (used in this way) as being one night/day cycle (Genesis 1:5). Thereafter, throughout the Bible, *yôm* used in this way always refers to a normal 24-hour day.<sup>2,3</sup> There is thus a *prima facie* case that, when God used the word *yôm* in this way, He intended to convey that the days of creation were 24 hours long.

Let us now consider what other words God could have used, if He had wanted to convey a much longer period of time than 24 hours.

### Some Hebrew 'time' words

There are several Hebrew words which refer to a long period of time.<sup>4</sup> These include *qedem* which is the main one-word term for 'ancient' and is sometimes translated 'of old'; *olam* means 'everlasting' or 'eternity' and is translated 'perpetual', 'of old' or 'for ever'; *dor* means 'a revolution of time' or 'an age' and is sometimes translated 'generations'; *tamid* means 'continually' or 'for ever'; *ad* means 'unlimited time' or 'for ever'; *orek* when used with *yôm* is translated 'length of days'; *shanah* means 'a year' or 'a revolution of time' (from the change of seasons); *netsach* means 'for ever'. Words for a shorter time span include *eth* (a general term for time); and *moed*, meaning 'seasons' or 'festivals'. Let us consider how some of these could have been used.

#### 1. Event of long ago

If God had wanted to tell us that the creation events took place a long time in the past, there were several ways He could have said it:

*yamim* (plural of *yôm*) alone or with 'evening and morning', would have meant 'and it was days of evening and morning'. This would have been the simplest way, and could have signified many days and so the possibility of a vast age.

*qedem* by itself or with 'days' would have meant 'and it was from days of old'.

*olam* with 'days' would also have meant 'and it was from days of old'.

So if God had intended to communicate an ancient creation to us, there were at least three constructions He could have used to tell us this. **However, God chose *not* to use any of these.**

### “How Long Were the Days of Genesis 1?”

Russell Grigg, *Creation* magazine 19 (December 1996): 23-25 (2 of 4)

## 2. A continuing event from long ago

If God had wanted to tell us that creation started in the past but continued into the future, meaning that creation took place by some sort of theistic evolution, there were several ways He could have said it:

*dor* used either alone or with 'days', 'days' and 'nights', or 'evening and morning', could have signified 'and it was generations of days and nights'. This would have been the best word to indicate evolution's alleged aeons, if this had been meant.

*olam* with the preposition *le*, plus 'days' or 'evening and morning' could have signified 'perpetual'; another construction *le olam va-ed* means 'to the age and onward' and is translated 'for ever and ever' in Exodus 15:18.

*tamid* with 'days', 'days' and 'nights', or 'evening' and 'morning', could have signified 'and it was the continuation of days'.

*ad* used either alone or with *olam* could have signified 'and it was for ever'.

*shanah* (year) could have been used figuratively for 'a long time', especially in the plural.

*yôm rab* literally means 'a long day' (cf. 'long season' in Joshua 24:7, or 'long time' in the New American Standard Bible). This construction could well have been used by God if He had meant us to understand that the 'days' were long periods of time.

Thus, if God had wanted us to believe that he used a long-drawn-out creative process, there were several words He could have used to tell us this. **However, God chose *not* to use any of these.**

## 3. Ambiguous time

If God had wanted to say that creation took place in the past, while giving no real indication of how long the process took, there were ways He could have done it:

*yôm* combined with 'light' and 'darkness', would have signified 'and it was a day of light and darkness'. This could be ambiguous because of the symbolic use of 'light' and 'darkness' elsewhere in the Old Testament. However, *yôm* with 'evening and morning', especially with a number preceding it, can never be ambiguous.

*eth* ('time') combined with 'day' and 'night' as in Jeremiah 33:20 and Zechariah 14:7 could have been ambiguous. Likewise *eth* combined with 'light' and 'darkness' (a theoretical construction). If any of these forms had been used, the length of the 'days' of creation would have been widely open for debate. **However, God chose *not* to use any of these.**

## Author's Intention

*The following considerations show us what God intended us to understand:*

1. The meaning of any part of the Bible must be decided in terms of the intention of the author. In the case of Genesis, the intention of its author clearly was to write a historical account. This is shown by the way in which the Lord Jesus Christ and the Apostle Paul regarded Genesis—that is, they quoted it as being truth, not symbolic myth or parable.<sup>5,6</sup> It was plainly not the author's intention to convey allegorical poetry, fantasy, or myth. And so what God, through Moses, said about creation in Genesis should not be interpreted in these terms.

Moses did, in fact, use some of the above 'long-time' words (italicized in the examples below, with root Hebrew words in square brackets), although not with reference to the days of creation. For example, in Genesis 1:14, he wrote, 'Let there be lights ... *for seasons [moed]*'; in Genesis 6:3, 'My spirit shall not



### “How Long Were the Days of Genesis 1?”

Russell Grigg, *Creation* magazine 19 (December 1996): 23-25 (3 of 4)

*always* [*olam*] strive with man'; in Genesis 9:12 'for *perpetual generations* [*olam dor*]'; in Leviticus 24:2, 'to burn *continually* [*tamid*]'; in Numbers 24:20 'that he perish *for ever* [*ad*]'; in Deuteronomy 30:20, 'He is thy light and the *length of thy days* [*yôm orek*]'; in Deuteronomy 32:7, 'Remember the *days of old* [*yôm olam*]'; and so on.

Why did God not use any of these words with reference to the creation days, seeing that He used them to describe other things? Clearly it was His intention that the creation days should be regarded as being normal earth-rotation days, and it was not His intention that any longer time-frames should be inferred.

Professor James Barr, professor of Hebrew at Oxford University agrees that the words used in Genesis 1 refer to 'a series of six days which were the same as the days of 24 hours we now experience', and he says that he knows of no professor of Hebrew at any leading university who would say otherwise.<sup>7</sup>

2. Children have no problem in understanding the meaning of Genesis. The only reason why other ideas are entertained is because people apply concepts from outside the Bible, principally from evolutionary/atheistic sources, to interpret the Bible.

3. The Bible is God's message to mankind and as such it makes authoritative statements about reality. If one removes any portion of the Bible from the realm of reality, God may still be communicating truth to us, but the reader can never be sure that he understands it as the author intended. Furthermore, if God's communication to us is outside our realm of reality, then we cannot know whether any account in the Bible means what the words actually say or whether it means something entirely different, beyond our understanding. For example, if we apply this criterion to the accounts of the resurrection of Jesus, perhaps the words could mean that Jesus did not rise from the dead physically, but in a way beyond our comprehension. When these sorts of word-games are played with the Bible, the Bible loses its authority, we lose the divine perspective on reality, and Christianity loses its life-changing power.<sup>8</sup>

4. If the 'days' really weren't ordinary days, then God could be open to the charge of having seriously misled His people for thousands of years. Commentators universally understood Genesis in a straightforward way, until attempts were made to harmonize the account with long ages and then evolution.

## Conclusion

In Genesis 1, God, through the 'pen' of Moses, is going out of His way to tell us that the 'days' of creation were literal earth-rotation days. To do this, He used the Hebrew word *yôm*, combined with a number and the words 'evening and morning'. If God had wanted to tell us it was an ancient creation, then there were several good ways He could have done this. If theistic evolution had been intended, then there were several constructions He could have used. If the time factor had been meant to be ambiguous, then the Hebrew language had ways of saying this. However, God chose not to use any construction which would have communicated a meaning other than a literal solar day.

The only meaning which is possible from the Hebrew words used is that the 'days' of creation were 24-hour days. God could not have communicated this meaning more clearly than He did in Genesis 1. The divine confirmation of this, if any is needed, is Exodus 20:9-11, where the same word 'days' is used throughout:

'Six *days* shalt thou labour, and do all thy work: But the seventh *day* is the sabbath of the LORD thy God: in it thou shalt not do any work, thou, nor thy son, nor thy daughter, thy manservant, nor thy maidservant, nor thy cattle, nor thy stranger that is within thy gates: For in six *days* the LORD made heaven and earth, the sea, and all that in them is, and rested the seventh *day*: wherefore the LORD blessed the sabbath *day*, and hallowed it.'

**“How Long Were the Days of Genesis 1?”**Russell Grigg, *Creation* magazine 19 (December 1996): 23-25 (4 of 4)**References and notes**

1. The author is indebted to James Stambaugh, 'The Days of Creation: A Semantic Approach', *Creation Ex Nihilo Technical Journal*, 5(1):70-78, 1991, for much of the material in this article, and to linguist Dr Charles Taylor of Gosford, NSW, Australia for his advice and help regarding the Hebrew. When we say 'days of 24 hours duration' we merely indicate that they were ordinary earth-rotation days, not that they were necessarily *precisely* 24 hours in length (the earth's rotation rate is gradually slowing down). Return to text.
2. M. Saebo, in his *Theological Dictionary of the Old Testament* 6:22, says that *yôm* is: 'the fundamental word for the division of time according to the fixed natural alternation of day and night, on which are based all the other units of time (as well as the calendar).' Cited from Ref. 1, p. 72. Return to text.
3. For a further discussion of the meaning of *yôm*, see Charles Taylor, *The first 100 words*, The Good Book Co, Gosford, NSW, Australia, 1996, p. 21. Return to text.
4. [4] The Hebrew words, anglicized spellings, and biblical references are cited from *Young's Analytical Concordance to the Bible*. Return to text.
5. See Mark 10:6; 13:19, for example. Return to text.
6. See Romans 5:12; 1 Corinthians 15:21-22, 45; 2 Corinthians 4:6; 1 Timothy 2:13-4:1. Return to text.
7. Source: letter from Prof. James Barr to David C.C. Watson, dated 23 April 1984. Note that Prof. Barr does not say that he believes that Genesis is historically true; he is just telling us what, in the unanimous opinion of the world's leading Hebrew-language professors (including himself), the Hebrew words used were intended to convey. Return to text.
8. Adapted from Ref. 1, p. 76. Return to text.

---

Available online at:

<http://www.answersingenesis.org/creation/v19/i1/days.asp>

COPYRIGHT © 2004 *Answers in Genesis*

## Creation Magazine

### Naming the animals: all in a day's work for Adam

Could Adam have named all the animals in one day?

by Russell Grigg

First published in:

*Creation* 18(4):46–49

September–November 1996

Genesis 1:24–27 states that God made the land animals, as well as the first man and woman, on Day Six of Creation Week. Genesis 2:18–23 tells us that Adam named the animals before Eve was created. So how could Adam have named all the animals in one day?

#### The time factor

Day Six of Creation Week began at evening (Genesis 1:31), and so consisted of about 12 hours of darkness followed by about 12 hours of daylight. There is no reason why God could not have made the land animals, and Adam too, during the darkness period of Day Six, so that at first light there they all were!

If, however, God used the daylight period, there is no reason to suppose that His creative acts in making the animals and Adam took any longer than the instant for Him to command these events to happen.<sup>1</sup> So either way it need not have taken any time at all beyond first light on Day Six for all the land animals and Adam to have come into existence.

Adam therefore had most of the daylight hours of Day Six in which to complete his task. Note that this task did not include his searching out the animal, because Genesis 2:19 tells us that God 'brought them unto Adam to see what he would call them'. Presumably this was in some sort of reasonably orderly procession.

#### Naming the animals

The following points need to be noted:

1. Genesis chapter 1 says that the animals were created according to their kinds, rather than according to their species—the phrase 'after his/their kind' occurs 10 times in this chapter (referring to both plants and animals). Exactly what the term 'kind' (Hebrew *min*) corresponds to in terms of the modern Linnaean classification system is not clear, but it appears that sometimes the *min* corresponds to today's species, sometimes to the genus, and sometimes to the family. It indicates the limitations of variation. What is clear is that numerically there must have been fewer kinds in Adam's day than the number of species we count today. [*Ed. note:* for more information, see *Ligers and wholphins? What next?*]

For example, it is more than likely that there would have been no domestic dogs, coyotes, and wolves as such, but rather one ancestral kind containing the genetic information for all of these to appear under natural selection pressures.

This is not evolution, because no new information is added. In the same way, the mongrel dog population of a few hundred years back was able to give rise (under human selection) to the various modern breeds of dog—because the information was already there in that population, much more than in today's specialized, genetically depleted breeds. That's why you can't start with a chihuahua population, and expect that breeding/selection will eventually produce Great Danes.

### “Naming the Animals: All in a Day’s Work for Adam?”

Russell Grigg, *Creation* magazine 18 (September-November 1996): 46-49 (2 of 5)

2. Today we divide the animals into those we call tame (mostly herbivores), and those we call wild (both herbivores and carnivores), but this distinction did not apply before Adam sinned.

Genesis 1:30 says, ‘And to every beast ... I have given every green herb for food’, and Genesis 1:31, ‘And God saw every thing that He had made, and, behold, it was very good.’ From these we conclude that animals did not kill each other for food pre-Fall, and they had no reason to fear man.

This means that we can regard them all as being tame at the time Adam named them. It also means that they would not have eaten each other, while taking part in any naming procession!

The animals which Adam named are specifically described in Genesis 2:20. They were the ‘cattle’, ‘the fowl of the air’ (birds), and ‘every beast of the field’. This classification has no correlation with today’s arbitrary system of man-made taxonomy (amphibians, reptiles, birds, mammals, insects), but is a more natural system based on the relation of the animals to man’s interests.

If we compare this naming list with the creation list in Genesis 1:20–25—birds and sea creatures (created on Day Five), beasts of the earth, cattle, creeping things—we see there are several very significant differences.<sup>2</sup> Adam was not required to name any of the sea creatures, or any of the creeping things. And as the beasts of the field were not specifically mentioned in the creation list, we can regard them as being a subdivision of the beasts of the earth. That is, Adam was required to name only some of the total land animal population of his own day.

There is no suggestion that the naming was meant to be comprehensive. From this it follows that Adam’s task was not to provide a scientific taxonomy, but a set of general names of a selection of the animals, for the benefit of average human beings who would come after him.

## So what animals were named?

### 1. The cattle (Hebrew: *behemah*)

The Hebrew term used here usually refers to animals which lend themselves to domestication—what we might call ‘domestic fauna’. Though no creatures were ‘wild’ in the modern sense, they would not all have been equally suitable for use by man.

It is interesting to note that most of the different breeds of what we call cattle today can be traced back to a single basic type, namely the aurochs, which itself is probably descended from the same created kind as the buffalo and bison group.<sup>3</sup>

Likewise, all the varieties of dog we have today have been bred from one basic dog/wolf type. Similar considerations may well apply to many other species of animals we use today, such as the horse.

All of this gives a total of a few dozen kinds at the most of *behemah* for Adam to name.

### 2. The fowl of the air

The Bible mentions some 50 different birds, whereas modern ornithologists divide the bird class into about 8,600 species. Of these, some 5,100 are in the order Passeriformes (perching birds), divided into suborders, families, and subfamilies; and there are about 3,500 species allotted to all other orders of birds in their families. Thus there are 285 species in the pigeon family, 127 species in the cuckoo family, 18 species in the penguin family, and so on.<sup>4</sup> So how many birds did Adam have to name?

It is instructive to consider what *Encyclopaedia Britannica* says about parrots. ‘The avian order Psittaciformes [parrots, lorries, cockatoos] contains more than 300 species of generally brightly colored, noisy, tropical birds, to which the general name parrot may be applied.’<sup>5</sup>

### “Naming the Animals: All in a Day’s Work for Adam?”

Russell Grigg, *Creation* magazine 18 (September-November 1996): 46-49 (3 of 5)

We do not know whether all such ‘parrots’ today are the descendants of one created kind, or whether the parrots of today descended from a handful of original kinds, which had (created) similarities to each other such that today we group them all under ‘parrot’.

If they were from one created kind, then instead of the 300 we have today, there would have been only one for Adam to name. Even if there were, say, three parrot kinds originally, it would have been fully legitimate (just as today) for these all to have been given the general term ‘parrot’. Therefore, only one representative from the three kinds would have been needed in the naming procession for the name ‘parrot’ (in whatever tongue Adam spoke) to have been given.

By the same reasoning, Adam probably named one ‘pigeon’, one ‘cuckoo’, one ‘penguin’, and so on.

*Colliers Encyclopedia* lists a total of 163 families of all living, fossil, and extinct birds.<sup>6</sup> This means that if Adam named only one representing each such modern group, to which *the same* ‘general name’ could be applied, then there could have been fewer than a couple of hundred birds involved.

### 3. The beast(s) of the field

The Hebrew word *sadeh*, translated ‘field’ in several Bible versions, has the meaning of a flat open plain. The term ‘beast(s) of the field’ occurs several times in the Old Testament. These are all in a post-Fall situation, that is, after sin had entered the world.

They included animals that move in when humans move out (Exodus 23:29), ‘wild asses’ (Psalm 104:11), ‘dragons and owls’ (Isaiah 43:20),<sup>7</sup> animals that prey on sheep (Ezekiel 34:8), and a range of carnivores (Ezekiel 39:17). As the condition of sin did not apply when Adam named the animals involved.

It is better to think of *sadeh* (‘field’) as referring to the habitat, although not perhaps to the extent of asking ‘which field?’ or ‘was the field the Garden of Eden?’

Taking all these factors into account, particularly the matter of habitat, the beasts of the field named were probably those animals which live today in open country and venture close to human habitation. Not named were probably those animals which live exclusively in forest, jungles, mountains, wetlands, deserts, etc.

On the basis of our earlier discussion concerning birds, it is clear that nowhere near the number of species extant today would have been involved. Adam presumably needed to name only one ‘snake’ (or at the most possible a few major anatomical differences, like ‘python’, ‘rattlesnake’, ‘cobra’). Likewise for many types of animals.

It is therefore completely inappropriate to talk of his having had to name the 6,000 species of reptiles or the 2,000 species of amphibians known today.<sup>8</sup> Quite apart from the fact that many, if not most, of these have been excluded on the basis of habitat anyway. Thus, even allowing for extinct types, it would seem more than generous to allow for counting of a thousand ‘beasts of the field’—in reality, the figure may well have been in the low hundreds.

## Was Adam equal to the task?

We learn language by association, but Adam, from the moment he was created, had language. Therefore he (and then Eve) must have already had built in ‘programs’ in their memory banks, so that when God said, ‘Don’t ...’ (Genesis 2:17), they immediately knew exactly what this meant. It seems that they must also have known what it would mean to die, even though they had never seen anything dead.

It is therefore reasonable for us to conclude that, at the ‘naming parade’, Adam could speak a precise language, using one or two words in place of a long description, just as our one word ‘elephant’ refers to ‘a large, big-eared, trunk-nosed, tusked quadruped’.

### “Naming the Animals: All in a Day’s Work for Adam?”

Russell Grigg, *Creation* magazine 18 (September-November 1996): 46-49 (4 of 5)

It also means that he did not need to ponder each decision. His naming of each different kind of animal could therefore have been both quick and appropriate, and also without confusion, for he would have had the capacity to recall the names he already had allocated with a pre-Fall memory that was crystal clear and voluminous.<sup>9</sup>

So, even in the unlikely event that there were as many as a thousand animals paraded before Adam, how long would it have taken him to name them?

There are 3,600 seconds in an hour, so Adam could have completed his task in under an hour. If he did it in a more leisurely and contemplative fashion, it would have taken a few hours at the most (excluding time out for ‘coffee breaks’!). Surely a pleasant day’s work, leaving plenty of time for God to create Eve from Adam’s side that same afternoon.

### Why?

Adam had been given dominion over the animals (Genesis 1:28), and God now provided him with the opportunity to exercise this responsibility in a way which established his authority and supremacy—in ancient times, it was an act of authority to impose names (cf. Daniel 1:7) and an act of submission to receive them.

This exercise also shows that Adam was not an ape-man, and indeed it was intended by God to show that he had no ape-like siblings among which to find fellowship or a mate (cf. Genesis 2:20b: ‘for Adam there was not found an help meet [i.e. helper suitable] for him’).

Contrary to the wishful thinking of evolutionists, the first man was not some stooped, dimwitted, grunting hominid, separated from his ape-like ancestors by a genetic mutation or two. The Bible portrays Adam as being essentially different from the animal world, because he had been created ‘in the image of God’ (Genesis 1:27).

This term refers primarily to man’s God-consciousness—his capacity for worshipping and loving God, his ability to understand and choose between right and wrong, and his capacity for holiness.<sup>10</sup>

A secondary meaning includes such things as man’s mental powers, reason, and capacity for articulate, grammatical, symbolic speech. In Adam, before sin, these capacities may have dwarfed anything we know today.

God in His omniscience would have foreknown the rise of humanistic naturalism in the twentieth century. This episode, way back in the Garden of Eden, highlights for those who have an eye to see it, the false and unbiblical nature of the evolutionary theory of human origins!

### References and notes

1. See R. Grigg, *Creation—how did God do it?* *Creation* 13(2):36–38, 1991. This shows that God’s creative ‘speaking’ in Genesis chapter 1 was equivalent to God’s ‘willing’ things to happen. Return to text.
2. Some skeptics and liberals have put forward the mistaken criticism that the order in Gen 2:19–20 is chronological, i.e. that Adam was created before the animals, contrary to the order given in Genesis 1:21–26. However, Genesis 2 is not a second and different creation account. This is shown by the omission of any mention of the formation of the sun, moon, stars, or sea. Rather, chapter 2 gives more details about certain aspects of the creation which particularly concerned Adam. It would be both legitimate and in keeping with the sense of the Hebrew to translate Genesis 2:19 thus: ‘Now the Lord God had formed out of the ground all the beasts of the field and all the birds of the air ...’. In fact, more than one modern translation of the Bible translates this verse in this way. There is no

**“Naming the Animals: All in a Day’s Work for Adam?”**Russell Grigg, *Creation* magazine 18 (September-November 1996): 46-49 (5 of 5)

contradiction. (See Genesis contradictions? for more details.) Return to text.

3. See Carl Wieland, Re-creating the extinct aurochs, *Creation* 14(2):25–28, 1992. Return to text.
4. ‘Birds’, *Encyclopaedia Britannica* 15:1–112, 1992. Return to text.
5. *Ibid.*, pp. 68–69. Return to text.
6. *Colliers Encyclopedia*, p. 210, 1994. Return to text.
7. Several modern translations of the Bible render ‘dragons’ (Hebrew *tannin*) as ‘jackals’. However, it is possible that ‘dragons’ (KJV) is a more correct term and refers, at least on occasion, to dinosaurs. If this is so, the number of dinosaurs named by Adam would have been limited, as with the other animals, to the comparative few whose habitat was flat open plains. Return to text.
8. Especially so, when it is realized that many snakes are classified today according to the presence, absence, or location of various internal parts. Return to text.
9. The human mind is capable of prodigious feats of memory, as for example chess players who can play several tens of games of chess ‘blindfolded’ (i.e. without sight of the board and communicating the moves by a recognised chess notation). Georges Koltanowski was a great expert, and also tackled 56 consecutive opponents blindfolded and won 50 games with 6 drawn, in 9.75 hours, on 13 December 1960 (*Guinness Book of Records*, p. 245, 1972); or Hiroyuki Goto, who recited *pi* to 42,195 places in Tokyo on 18 February 1995 (*New Guinness Book of Records*, p. 309, 1996). Adam’s mind at this stage was not affected by either genetic defects or sin. Return to text.
10. The capacity for holiness, though flawed in the case of Adam and all of his descendants (us) because of sin, was perfectly shown in the life of the Lord Jesus Christ. Return to text.

---

Available online at:

<http://www.answersingenesis.org/docs/1254.asp>

COPYRIGHT © 2004 *Answers in Genesis*

## Archaeological Periods

John H. Walton, *Chronological & Background Charts of the Old Testament*, 2d. ed., 78



ARCHAEOLOGICAL PERIODS IN PALESTINE	APPROXIMATE DATES B.C.	EGYPTIAN DYNASTIES	APPROXIMATE DATES B.C.	BIBLICAL CORRELATIONS	APPROXIMATE DATES B.C. (early chronology)
Neolithic Pre-pottery Neolithic Pottery	8000-6000 6000-4300				
Chalcolithic	4300-3300	Badarian, Nagada	3900-3300		
Early Bronze I Early Bronze II Early Bronze III Early Bronze IV	3300-2900 2900-2600 2600-2300 2300-2100	I and II III to V (Pyramid Age) First Intermediate Period (VII-X)	3000-2700 2700-2350 2190-2010	Post Flood	
Middle Bronze I Middle Bronze IIA Middle Bronze IIB Middle Bronze IIC	2100-1900 1900-1700 1700-1600 1600-1550	XII Second Intermediate Period Hyksos	1963-1786 1786-1550 1648-1540	Patriarchs  Sojourn in Egypt	2150-1850  1876-1446
Late Bronze I Late Bronze IIA Late Bronze IIB	1550-1400 1400-1300 1300-1200	New Kingdom XVIII Empire Age XIX	1550-1295 1295-1186	Conquest  Judges	1406-1400  1400-1050
Iron IA Iron IB Iron IC	1200-1150 1150-1000 1000-918	XXI	1069-945	United Monarchy	1050-930
Iron IIA Iron IIB	918-800 800-586	XXII XXVI	945-715 664-525	Divided Monarchy	930-586
Iron III	586-332			Captivity	586-539



# Creation Theories

## Creation Theories

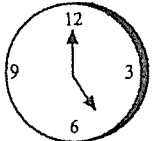
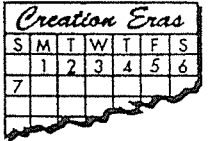
John H. Walton, *Chronological and Background Charts of the OT*, 2d ed., 97

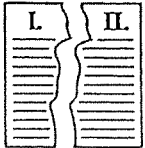
THEORY	DESCRIPTION	UNDERSTANDING OF TIME	TREATMENT OF "DAY"	MAJOR PROBLEMS
<p>24-HOUR DAY</p> 	Views chapter 1 as sequential and literal	Most support "young earth."	24 hours	<ul style="list-style-type: none"> <li>Reconciling with scientific data</li> <li>Integrating chapters 1 &amp; 2</li> </ul>
<p>DAY-AGE</p> 	Views creation as taking place over six eras	Unlimited time available for each era	Day = age	<ul style="list-style-type: none"> <li>Sequence still does not suit scientific data</li> <li>Difficult to substantiate author's intention as day = age</li> <li>Often an excuse for evolution</li> </ul>
<p>LITERARY APPROACH</p> 	Views seven-day sequence as a literary structure	Narrative has nothing to say about time	Oriented toward sabbath theology	<ul style="list-style-type: none"> <li>Exodus 20:11</li> <li>Difficult to preclude time significance only on basis of literary structure</li> </ul>
<p>PRIOR CREATION</p> 	Suggests existence of a previous created world prior to Genesis 1	Most of scientific ages related to prior creation	24 hours	<ul style="list-style-type: none"> <li>No textual support</li> <li>Questions of continuity in scientific record</li> <li>Sun/moon</li> </ul>
<p>TWO-PHASE</p> 	Two distinct phases of creation in chapters 1 & 2 with long period of time in between	Gap between 2:3 and 2:4 can accommodate any time requirements	Any view possible	<ul style="list-style-type: none"> <li>People in chapter 1 are not Adam and Eve and must be viewed as not yet morally responsible</li> </ul>

## The Kingdom in Genesis

### The Nature of the Kingdom of God

Interestingly, the phrase “the kingdom of God” never appears in the Old Testament. However, the concept is actually the most important theme! The kingdom theme presupposes the existence of a ruler, land, people, and rules (covenants) to govern the kingdom. Goldsworthy describes the concept of the kingdom of God as *God’s people in God’s place under God’s rule*. From the text of Genesis, we can deduce that the kingdom of God has two main manifestations – (i) a universal kingdom that encompasses the heavens as well as all the nations of the earth and (ii) a redemptive kingdom centered on God saving all who place their faith in Him. “Abraham believed the LORD, and he credited it to him as righteousness” (Gen 15:6) shows that Abraham entered this redemptive kingdom by faith (cf. Rom. 4:3).

### The Universal Kingdom of God

Genesis 1-2 depicts God as ruler over all creation. The depiction of a self-existent, solitary, self-sufficient Creator differs sharply from other ancient creation accounts. As Creator the LORD God shows Himself to be the boss over all. Genesis demonstrates His kingship in several ways:

1. Ancient kings typically did not follow a previously written code as an authority over their rule. Instead, *the king’s word itself* was law and conveyed authority, creating reality. Likewise, since God created the world simply through his spoken word (Gen. 1), he thus demonstrated his authority over the entire creation.
2. Whereas Babylonians worshipped the sun (god Shamash) and moon (god Sin), Genesis portrays both entities as being created (Gen. 1:16). Thus, Yahweh is king over these so-called gods.
3. God’s mandate for man to rule over creation also shows his sovereignty, for man could not be commanded to rule under God unless God was the Ultimate Ruler (Gen 1:26).
4. God’s ability and right to judge people demonstrates His rule over all. This is seen in judging Adam, Eve and Satan in the Garden of Eden (Gen. 3); Cain (Gen. 4); all who perished in the Flood except for Noah and his family (Gen. 6-9); and man’s rebellion at Babel (Gen. 11).

### The Redemptive Kingdom of God

The first hint at the redemptive kingdom or the restoration of man to fellowship with God is found in Genesis 3:15. However, the first explicit reference to the kingdom of God which is usually called “the theocracy” appears at the time of the Exodus, where Jehovah promises the people that they shall be made to Him “a kingdom of priests” if they obey His law (Exod. 19:6).

Thus, the kingdom statement of Genesis is as follows –

*God created a perfect kingdom with man as co-ruler (Gen 1-2), but man gave his rule to Satan (Gen 3) so God elected a seed to produce a Ruler (Gen 4-11) to bless all nations in Abraham (Gen 12-50).*

## Election in Genesis

### The Nature of Election

Just as the phrase “the kingdom of God” never appears in the Old Testament, the same can be said of the term “election” (in the NIV). However, once again the concept is actually the most important theme in Genesis. It simply means that God can choose whatever and whomever He desires to accomplish His purposes. Therefore, “election” often finds “choice” as a close synonym.

### Evidence of Election in Genesis

Page 62 has already noted the pattern of God repeatedly choosing the younger son over the older son throughout Genesis. This underscores that God does not follow the conventions of the day. Instead, He is creative, choosing the best way even if no one does so.

However, there are many other ways that God elected (chose) in Genesis. It’s all over the book:

- God chose to create the world (1:1)
- God chose to share His rule with man (1:26-27)
- God chose to give man a perfect garden (2:8)
- God chose to grant Adam the best “prime rib” ever—Eve herself (2:21)
- God chose to judge Adam, Eve and the serpent for sin (3:8-19)
- God chose to make his line of blessing go through Seth (4:25-26)
- God chose to allow sin to lead to death for the entire race (Gen. 5)
- God chose to flood the earth (Gen. 6-9)
- God chose to make a covenant never to flood the entire earth again (9:15)
- God chose to have all peoples of the planet to trace their lineage to Noah (Gen. 10)
- God chose to scatter the inhabitants into different language groups (Gen. 11)
- God chose to make a covenant nation to bless the world through Abraham (12:1-3)
- God chose to give certain boundaries to Abraham’s descendents (15:18)
- God chose to give the land of Israel to Abraham’s descendents forever (17:7-8)

The above list goes only up to chapter 17 and even skips many ways God chooses within these chapters. What other ways do you see God exercising His right to choose in Genesis?

### Sovereignty and Election

Since God is sovereign over all, no one can rightfully argue with His choices. Many years after Genesis, the LORD told Jeremiah, “O house of Israel, can I not do with you as this potter does?” declares the LORD. ‘Like clay in the hand of the potter, so are you in my hand, O house of Israel’” (Jer. 18:6). Therefore, sovereignty and election are intricately related. The kingdom theme and the election theme are opposite sides of the same coin in Genesis—indeed, in the Bible as a whole.

## The Consummation of All Things

### *Genesis vs. Revelation*

#### Genesis 1—3

#### Revelation 20—22

"In the beginning God created the *heavens and the earth*" (1:1)

"The darkness He called *night*" (1:5)

"God made *two great lights*" (sun and moon; 1:16)

Trees and rivers (2:8-14)

"In the day you eat of it you will surely *die*" (2:17)

Husband and wife (2:18-25)

Satan *appears* as deceiver of mankind (3:1)

Defilement *enters* the garden (3:6-7)

Fellowship with God *broken* (3:8-10)

*Initial* triumph of the *serpent* (3:13)

"I will greatly *multiply your sorrow*" (3:16)

"*Cursed* is the ground because of you" (3:17)

Man's dominion *broken* in the fall of the first man, Adam (3:19)

First paradise *closed* (3:23)

*Prohibition* from the tree of life (3:24)

Man *driven from God's presence* (3:24)

"Then I saw a *new heaven and a new earth*" (21:1)

"There will be *no night* there" (21:25; 22:5)

"The city *does not need the sun or the moon*" (21:23)

Tree and river (22:1-2)

"There will be *no more death*" (21:4)

Lamb and bride (19:6-9)

Satan *disappears* forever (20:10)

Defilement *never enters* the city (21:27)

Fellowship with God *resumed* (21:3)

*Ultimate* triumph of the *Lamb* (20:10; 22:3)

"There will be *no more... sorrow or crying or pain*" (21:4)

"*No longer* will there be any *curse*" (22:3)

Man's dominion *restored* in the rule of the new man, Christ (22:5)

New paradise *opened* (21:25)

*Access* to the tree of life (22:14)

"They will *see His face*" (22:4)

\* Adapted from Bruce Wilkinson and Kenneth Boa, *Talk Thru the Bible* (Nashville: Nelson, 1983), 515.

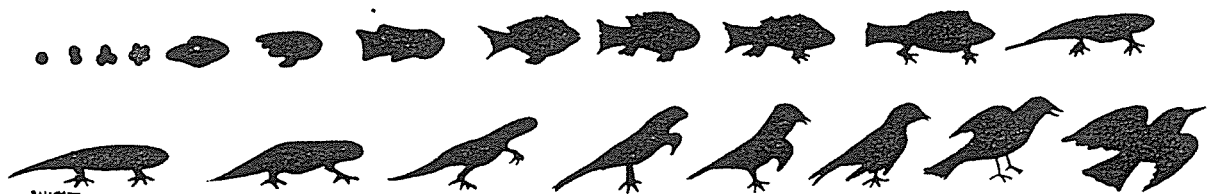

Evolutionists claim a fish gradually turned into a bird over a long period of time. The fossil record, however, has never revealed

remains of any of the in-between, or *transitional*, stages of development that are pictured here.

# Biblical vs. Babylonian Creation Accounts

John H. Walton, *Chronological and Background Charts of the OT*, 2d ed., 80

GENESIS ACCOUNT	ENUMA ELISH
God is seen as ultimate source of power; transcends creation.	Magic incantations are ultimate source of power; the gods are subject to nature. III. 101; IV. 1-26, 91*
Organized coverage of creation; systematically includes general realms of nature.	Does not include creation of vegetation, animals or light—the existence of these is assumed. Moon and stars created, but not sun. V. 2-22
Purpose: Praise to God as Lord of creation; acknowledging Him as such. A tribute to God's ultimacy and authority.	Purpose: Hymn of praise to Marduk as champion and mightiest of the gods. Creation is incidental. VI. 100ff.
Begins before things as we know them existed (Gen. 1:1); as God created, He gave names. Gen. 1:5, 8, 10	Begins before heaven and earth were <i>named</i> ; cannot imagine situation before they existed. I. 1-2
Starts with primeval deep. Hebrew: <i>tehom</i> Gen. 1:2	Starts with the deep—fresh water (Apsu) and salt water (Tiamat—cognate of <i>tehom</i> ). I. 3-4
Creation given time sequence; set in blocks by “days.” Gen. 1:5, 8, 13, etc.	No chronological structure of “days.”
Creation by speech. Gen. 1:3, 6, 9, 11, 20	Creation from formerly existing matter. IV. 137-140; VI. 33
Waters separated above and below by firmament. Gen. 1:6-8	Corpse of Tiamat divided in two and set up as waters above and below. IV. 137-140
Man created to rule creation. Gen. 1:28	Man created to do the service of the gods so the gods wouldn't have to work so hard. VI, 8, 34
Man created from the soil. Gen. 2:7	Man created from blood of slain hero (Kingu). VI. 33

\*Enuma Elish references designate tablet number and line.

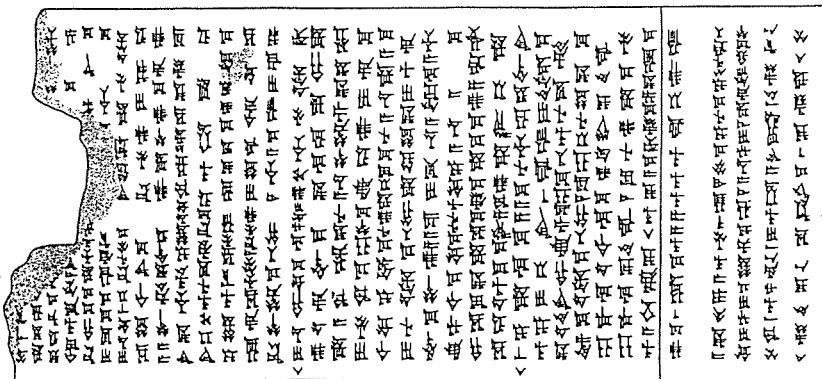

Tablet IV of the Babylonian Creation Story (Enuma elis)

## Creation vs. Evolution

	Creation	Evolution
<i>Source for belief</i>	God's Word	Man's speculations
<i>Basis for belief</i>	Reasonable faith (no eyewitnesses or repeatable events, but order stemming from order)	Leap of faith (no eyewitnesses or repeatable events, but order stemming from disorder)
<i>Assumption about God</i>	God exists	God does not exist
<i>Cause for ordered universe</i>	Primary (intelligent) causes	Secondary (natural) causes
<i>Foundation of the cause</i>	Design	Chance (accidents)
<i>Origin of matter</i>	God's spoken word	No explanation
<i>Origin of universe</i>	God's spoken word made the right balance of air molecules, enough water (found only on earth), the right distance from the sun, a protective ozone layer to allow visible light to pass through but keeps out harmful ultraviolet light, a perfect 23.5 degree tilt to produce seasons, the correct orbits for the planets, etc.	Big Bang: all the energy and matter exploded, creating hydrogen gas molecules that collected themselves into stars (but this contradicts scientific fact that gas pressure pushing out is 100 times stronger than gravity pulling in—also, no one has ever seen an explosion create order!)
<i>Age of universe</i>	6,000-10,000 years	5 billion years
<i>Use of term "prehistoric"</i>	Inappropriate	Appropriate
<i>Origin of intelligence</i>	Outside intelligent source (God)	Evolved from non-intelligent matter
<i>Origin of the first life forms</i>	God's spoken word (Gen. 1:1)	A simple life form—life created itself. (Actually, there exists no such thing as the least complicated single cell—the bacterium is vastly complex.)
<i>Origin of man</i>	God's spoken word (Gen. 1:26-27)	Descended from bacteria, onions, cockroaches, snakes, and apes as a result of millions of DNA accidents

	<b>Creation</b>	<b>Evolution</b>
<i>Origin of man's soul</i>	Given by God (Gen. 2:7)	Does not exist or was added later
<i>Origin of human ethnic groups</i>	Intermarriage within the same language groups produced concentrations of genes (Gen. 11)	No explanation has been offered
<i>Origin of species</i>	Life always gives rise to life (the first immutable law of biology)	Life arose from dead, inorganic matter
<i>Propagation of species based on...</i>	Science (observed facts: all species reproduce after their own kinds; cf. Gen. 1:21, 24-25). In other words, like always gives rise to like (the second immutable law of biology).	Theory (unproved, unobserved ideas: e.g., while beings change or mutate to <i>higher</i> forms only once in 10,000 times, this miracle occurred millions of times to produce humans)
<i>Transitional life forms</i>	None required, none ever discovered	Millions required, none ever discovered
<i>View of historical events</i>	Catastrophism: the world has changed weather (climate), topography, etc. due to a worldwide Flood (and possibly an Ice Age)	Uniformitarianism: the world has continued with the same weather, erosion, etc. since time began (except an Ice Age?) as scoffers predict in 2 Pet. 3:4-5
<i>Relationship to 2nd law of thermodynamics ("all things move from order to disorder")</i>	Consistent with this law	Contradicts this law
<i>Man and dinosaurs</i>	Coexisted	Dinosaurs predated man by millions of years
<i>Depends on creativity from...</i>	the Creator	the created (man)
<i>Popularity among laymen</i>	Majority view	Rare
<i>Popularity among scientists</i>	Rare	Majority view
<i>Accountability to a Creator</i>	Great (man will be judged)	None (no judgment will occur)

Another suggestion appeared in the January 6, 1982, issue of the *Minneapolis (Minnesota) Tribune*: “The extinction of the dinosaurs may have been caused by a giant asteroid that slammed into the earth 65 million years ago. The asteroid collision kicked up a huge cloud of dust containing iridium. The dust obscured the sun for three to six months, destroying the plants on which the dinosaurs fed.”

Intriguing as they may sound, all long-ages theories have serious problems. Prior to the Flood, it's likely that the earth's worldwide climate was subtropical under the “water canopy” or dense clouds. Evidence suggests that after the Flood, most of the earth was significantly cooler than before. The dinosaurs on the ark (probably young dinosaurs!) left to find a different climate. Unable to adjust to the temperature and changes in vegetation, many of their species died and became extinct.

#### A RADIOMETRIC DATE MAY MAKE YOU LATE

One of the best-known ways of assigning age to an object is through several techniques known jointly as radiometric dating. One method — radiocarbon dating — is especially intended to date fossils of living things.

Radiometric dating is based on the fact that some radioactive elements undergo decay to produce new elements. In the case of uranium-lead dating, uranium 238 (the “parent element”) will eventually decompose to produce lead 206 (the “daughter element”). Scientists can measure the quantities of radioactive elements in rocks today, and estimate how long it's been since the rock cooled from its molten state. This gives an “age” for the rock.

Many scientists have sworn by radiometric dating methods. But are these dates truly reliable? Actually, radiometric dating is based on some fragile assumptions. If the assumptions are false, the dating procedure is worthless. For radiometric dating to be accurate several critical factors must be known or be true:

1. We must know the quantity of radioactive elements which were in the rock when it was first formed.
2. The rate of radioactive decay must be constant over time.
3. The rocks being measured must be isolated from outside factors.

These factors can be illustrated in the following way. Imagine yourself being a police investigator. You have discovered an abandoned car used in a robbery. To help identify the thief's hideout, you need to figure how far

the car had been driven. First, you measure the amount of gasoline in the tank right now. But to answer the question, you must also consider three other factors, each corresponding to the radiometric facts above:

1. How much gasoline was in the tank when it left the hideout?
2. What is the car's fuel consumption rate in miles per gallon?
3. Does the tank have a fuel leak, or has any fuel been added since leaving the hideout?

As the police investigator, you will likely have a hard time pinning down the distance to the thief's hideout. Why? Because the information you need, especially questions 1) and 3), is likely impossible to know.

Similarly, the accuracy of radiometric dating is questionable in these same three critical factors:

1. We must know the quantity of radioactive elements that were in the rock when it was first formed.

**BUT:** It is impossible to know the quantity of radioactive elements in a rock when it was first formed, whether thousands, millions, or billions of years ago. We can only speculate. In most calculations, it is assumed that no daughter element was present when the rock formed, but there is no way to prove this. We also know from recently “created” rock from lava flow that this assumption is invalid. Sometimes the daughter element is already present.

2. The rate of radioactive decay must be constant over time.

**BUT:** Current evidence suggests that radioactive decay is indeed constant, and is not affected by heat or pressure. However, decay rates have been examined for only about 100 years. Nuclear physicist Dr. Russell Humphreys demonstrates research known as radiohalo analysis that suggests that decay rates used to be faster.

Frederic B. Jueneman stated in an article from the reputable journal *Industrial Research and Development*:

There has been in recent years the horrible realization that radio decay rates are not as constant as previously thought, nor are they immune to environmental influences.<sup>15</sup>

We have no assurance what the radioactive decay rates were thousands, and certainly not billions, of years ago.



3. The rocks being measured must be insulated from outside factors.

BUT: Argon, one of the most measured radioactive elements, is a gas and can easily diffuse out of rock. Potassium and uranium (two other commonly measured elements) are easily dissolved in water. Water seeping through rock could easily dissolve away these elements, leading to inaccurate measurement. In reality, both parent and daughter elements migrate into the rocks from tectonic, metamorphic, and hydrologic forces. Geochronologists recognize this to be a serious and common problem with their dating method dogma.<sup>16</sup>

Though radiometric dating has been perfected for many years, the measurements are often very inaccurate. For example:

- Analysis of wood from Australia by the radiocarbon (C-14) method revealed it to be 45,000 years old. But analysis by the potassium-argon method put the wood at about 45 million years old.<sup>17</sup>
- In another find, fossilized wood from Upper Permian rock layers was found to have radioactive carbon 14 present. The radiometric age assigned to these rock layers was 250 million years. Yet other research reveals that all detectable carbon 14 should have disintegrated if the wood were older than 50,000 years.<sup>18</sup>
- A particular rock from Mount St. Helens volcano was obviously formed in 1986 when it cooled. But examination with the potassium-argon (K-Ar) radiometric method, determined it to be 350,000 years old, give or take 50,000 years.<sup>19</sup>
- Newly formed rocks from the Mount Ngauruhoe volcano in New Zealand were also examined. The radiometric age of the rocks ranged between 270,000 and 3,500,000 years. However, these rocks were formed during eruptions between 1949 and 1975.<sup>20</sup>

Wakefield Dort Jr., of the department of geology at the University of Kansas, gives further examples:

Radiocarbon analysis of specimens obtained from mummified seals in southern Victoria has yielded ages ranging from 615 to 4,600 years. A seal freshly killed at McMurdo had an apparent age of 1,300 years.<sup>21</sup>

Dr. Harold Slusher, an astrophysicist and geophysicist, adds:

Studies on submarine basaltic rocks from Hawaii, known to have formed less than 200 years ago, when dated by the potassium-argon method, revealed “ages” from 160 million to almost 3 billion years.<sup>22</sup>

Dr. Alan C. Riggs, formerly of the U.S. Geological Survey and now on the staff of the University of Washington, Seattle, gives yet another example:

By radiocarbon dating, living snails “died” 27,000 years ago!<sup>23</sup>

So much for reliability! If radiometric dates are so unreliable for objects of known ages, then how can we trust the method for determining the age of unknown objects?

#### CALLING ON THE EXPERTS

Given these inaccuracies, it's no wonder that many scientists broadly question the usefulness of radiometric dating:

William D. Stansfield, Ph.D., instructor of biology at California Polytechnic State University, declares:

It is obvious that radiometric techniques may not be the absolute dating methods that they are claimed to be. Age estimates on a given geological stratum by different radiometric methods are often quite different (sometimes by hundreds of millions of years). There is no absolutely reliable long-term radiological “clock.” The uncertainties inherent in radiometric dating are disturbing to geologists and evolutionists.<sup>24</sup>

Richard L. Mauger, Ph.D., associate professor of geology at East Carolina University, admits with reference to radiometric dating:

In general, dates in the “correct ball park” are assumed to be correct and are published, but those in disagreement with other data are seldom published nor are discrepancies fully explained.<sup>25</sup>

Robert E. Lee documents in “Radiocarbon: Ages in Error”:

The radiocarbon method is still not capable of yielding accurate and reliable results. There are gross discrepancies, the

chronology is uneven and relative, and the accepted dates are actually selected dates. This whole blessed thing is nothing but 13th century alchemy, and it all depends upon which funny paper you read.<sup>26</sup>

Radiometric dating, long considered a secure means of determining age, must be viewed realistically. Its accuracy is highly unreliable. Yet this fact is seldom admitted. Current textbooks often present such views as proven facts. It is clearly time for parents to know the truth, for students to hear the truth, and for professors to teach the truth. Anything less is simply dishonesty.

#### NOT AS OLD AS YOU'VE BEEN TOLD

Numerous other methods have been used to suggest the earth's true age. Taken as a whole, they give a more reliable indication. Consider some of them:

##### • **Magnetic field intensity**

The earth's magnetic field is rapidly decreasing in strength. Assessing the rate of decrease tells us about the planet's age. Dr. Thomas Barnes, one of the most respected magnetic field physicists in the world, explains:

If we went back about ten thousand years, the earth's magnetic field would have been as strong as the field in a magnetic star. A magnetic star is like our sun; it has a nuclear power source. Surely our earth never had a nuclear source like the sun. Surely our earth never had a magnetic field stronger than that of a star. That would limit the age of the earth to ten thousand years.<sup>27</sup>

Calculations on the magnetic field by other investigators also reveal that it couldn't be more than about 10,000 years old.<sup>28</sup>

##### • **Concentration of ocean salt**

The concentration of salt in the oceans is steadily growing. Yet the oceans are not nearly salty enough to have existed for billions of years. Even with generous allowances, the salt concentration suggests they could be no more than 62 million years old.<sup>29</sup>

##### • **Preserved red blood cells**

Preserved red blood cells and hemoglobin have been discovered in unfossilized dinosaur bones. Evolutionists dated the dinosaur as living 65

million years ago. However, research shows that such cells could not survive more than a few thousand years. The dinosaur must have lived recently.<sup>30</sup>

##### • **Absent supernova**

Supernova is the name given for the tremendous explosion of a star. It creates a brief light far brighter than any other object in a galaxy. Calculations suggest that the remains of supernovas continue shining for hundreds of thousands of years. Yet observations of our own Milky Way Galaxy do not show any old supernova. This fact suggests the galaxy has not existed long enough for these to have occurred.<sup>31</sup>

##### • **Helium concentration**

Helium concentration in our atmosphere is gradually increasing. Yet the current amount is only about 1/2000 of what we'd expect if the atmosphere were billions of years old. The helium concentration suggests a much younger atmosphere.<sup>32</sup>

##### • **World Population Growth**

World population growth is estimated by many population experts to be an average of about two percent per year. To be very conservative, if the population only increased one-half percent per year (allowing generously for plagues, wars, starvation, etc.), in one million years (the evolutionists general estimate of the age of man on planet Earth) there would have been  $10^{2100}$  people somehow stacked on the earth. (That number of people would actually fill countless trillions of entire universes.) Even if an almost zero growth rate of population were assumed, in a million years the earth would have housed 3,000,000,000,000 people up until the present age. There is no cultural or fossil evidence for numbers anywhere near that level.

At the one-half percent growth rate, it would take about 4,000 years to produce today's population from a single couple. This is the approximate amount of time elapsed since the worldwide flood when only Noah's family was spared.

##### • **Earth-moon distance**

Measurements show that the moon is slowly withdrawing from the earth. Each year, the distance increases by about 1-1/2 inches, though the rate was likely greater in the past. Calculations show that even if the moon

had been in contact with the earth, it would have taken only 1.37 billion years to reach its present distance. This gives a maximum possible age of the moon — not the actual age. This maximum age is still far too young for evolution to have had time to occur, and much younger than the radiometric “dates” assigned to moon rocks. Since the precise distance of the moon from the earth is critical for regulating ocean tides, the age must be a fraction of that amount of time.<sup>33</sup>

#### • Absent Meteorites

Where are the meteorites in the multi-billion-year-old geological column? While most meteors burn up before they reach the earth's surface, many (up to 60 tons each day) land on the earth. If the supposed geological layers were laid down over millions of years, where are the meteorites in the layers? Few such meteors have been found in the geological layers.<sup>34</sup>

#### • “Short Period” Comets

Our solar system has an abundance of “short period” comets, that is, comets whose life span averages only 1,500 to 10,000 years. Yet if the universe is billions of years old, these comets would have disintegrated long ago. Evolutionists have had to scramble to try and explain their existence.<sup>35</sup>

### AGE IS NO REQUIREMENT

Looking for other evidence of the earth's age? Petrified objects, the formation of coal, coral reefs, and the Grand Canyon are also said to prove a very old earth. But recent discoveries make these arguments more difficult to support. Instead, they all point toward the probability of a young planet.

#### • Petrification

The time necessary for wood and other objects to become petrified is said to be on the order of thousands of years. But consider the findings of H.G. Labudda of Kingaroy in southeast Queensland, Australia, who specializes in the collection of petrified objects. Among the articles of his collection is a perfectly petrified orange. Oranges were not raised in the area until 1868.<sup>36</sup>

#### • Coal Formation

In many places are fossilized trees penetrating through several coal layers. This indicates that the surrounding coal was formed so quickly

that termites did not have time to consume the wood! Rather than taking millions of years to form coal, available evidence indicates that coal may form in a very short time, geologically speaking, if conditions are favorable.

#### • Coral Formation

Coral is said to grow only slowly, and that reefs take millions of years to form. Yet underwater explorers recently found a five-foot diameter coral growth on the bow gun of a sunken ship. Coral can indeed grow much more rapidly than previously thought.<sup>37</sup>

#### • Canyon Formation

Some geologists have declared that, given its depth, the Grand Canyon and other geological strata must have taken more than eight million years to form. However, we know today that some comparatively small “natural disasters” can have the same affect much more quickly.

On March 19, 1982, Mount St. Helens' volcano exploded with a force equal to 20,000 Hiroshima-sized atom bombs. As an aftermath of the eruption, a 140-foot-deep canyon (the “Little Grand Canyon”) was formed in

## The Age of the Atmosphere

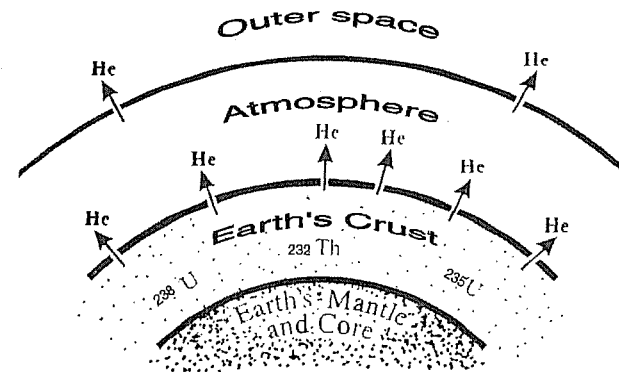

*All of the helium now in the atmosphere would accumulate in a maximum of 2 million years.*

just one day! At this rate, the Grand Canyon could have been formed in only 40 days!

Since the eruption, new layered strata of rock (like walls of the Grand Canyon) have also continued to form at the rate of 100 feet per year (in one case 25 feet in one day).<sup>38</sup>

Furthermore, the walls of the Grand Canyon reach over 6,000 feet above sea level. The river that supposedly “carved” these walls “billions of years ago” enters the canyon at only 2,800 feet above sea level. Rivers don’t flow uphill! To “carve” those walls, the river would have had to flow uphill over 3,200 feet vertically! Clearly, the river did not form the Grand Canyon!

Eastern Washington has its “channeled scablands” — 15,000 square miles of steep-walled canyons, gouged out of crystalline lava rock. Researchers initially assumed these canyons were the aftermath of a river eroding the earth over many millions of years. United States Geological Survey, however, published the fact that the scablands were actually formed from the “Great Spokane Flood” in just two days!

#### WAIT! THERE IS STILL MORE!

There exist many other dating methods we have yet to touch on. The following are examples from a list of 102 dating methods that further suggest a very young earth and young universe:

- Volcanic activity of Jupiter’s moon, Io
- Saturn’s unstable rings
- The solar dust ring discovery
- Basaltic lunar craters
- The mystery of Sirius B
- The field-galaxy mystery
- Radiohalos
- Polonium Halos
- Chorine leaching
- Chorine influx
- Dust speed
- Galaxy mass
- Galaxy spirals
- Helium in zircons
- Lead in zircons
- Lead influx

- Sediment accumulation
- Sediment lithification
- Sodium leaching
- Sodium influx
- Strata unconsolidation
- Strontium formation
- Strontium influx
- Uranium influx<sup>39</sup>

Evidence from the study of these subjects presents considerable challenge to the idea of a very old earth. It is likely impossible to prove the earth’s age using any one scientific method. This is because it is not feasible to have all the information needed from events that happened long ago. What we must do in these situations, scientifically speaking, is to gather as much data as possible and draw the best conclusions we honestly can.

The greatest weight of scientific evidence points toward a young earth. Not one in the “billions of years old” range, but rather consistent with a “thousands of years old” planet.

#### BIG BANG?

When further pondering the age of our planet, it’s often taught that the universe began as a “big bang.” Consider this statement from a high school textbook:

A fireball exploded 15 to 20 billion years ago. Then matter and energy spread outward in all directions, cooling as it expanded. After about 500,000 years, hydrogen gas formed. The gas collected into clouds which formed galaxies during the next half billion years. Now all that remains are galaxies and radiation. Within the galaxies, stars form and die and new ones form. . . . Probably the most widely accepted theory for the origin of the solar system is the dust cloud theory. According to this idea, a dust cloud began to rotate. . . . When the mass had swept up most of the material in an eddy, a planet was formed.<sup>40</sup>

Some scientists hold that the universe began with an incredible explosion of a very dense ( $10^{25}$  g/cc) sub-atomic particle, sometimes called the “cosmic egg.” That explosion somehow resulted in a very vast, ordered universe (with over 100 billion galaxies), solar system, life-supporting planet

Earth, and advanced forms of human life. The big-bang theory says that all this order resulted from the random effects of an explosion!

This theory is, however, scientifically impossible and intuitively unbelievable. Observations and experiments show that explosions always produce disorder and chaos. Nowhere in the universe has a single explosion been historically observed that produced higher order and greater complexity. This fact is summed up in the second law of thermodynamics:

Complex ordered arrangements and systems naturally become simpler and more disorderly (increased entropy or randomness) with time.

This law is universal. Ordered arrangements (such as our solar system) also require a high degree of energy to maintain them. Yet, the second law also states that usable energy in the universe is becoming less and less as arrangements become more and more random. In a sense, the universe is like the constant unwinding of a great clock.

A “big bang” type of explosion always, always, always destroys complexity and produces disorder. Rather than forming planets and star systems, matter should have continued expanding and dissipated completely, for in outer space there is nothing to stop a moving object. Yet the universe demonstrates incredible order and design. The big-bang theory simply defies the laws of science and logic, yet is still clung to in spite of the facts.

What are the odds that such an explosion could produce the highly organized structures we see in the universe? Carl Sagan (himself an evolutionist and astronomer) gives it the immense odds of 1 to  $10^{2,000,000,000}$  — that is 1 to 10 followed by two billion zeroes. Absolutely impossible!<sup>41</sup>

Other profound questions are also left unanswered. What was the origin of the “cosmic egg” itself? Where did this first dense particle come from? From where was the enormous energy supplied? The big-bang theory has no answer to these essential queries, as voiced by A. Krauskopf and A. Beiser:

A number of scientists are unhappy with the big bang theory. . . . For one thing, it leaves unanswered the questions that always arise when a precise date is given for the creation of the universe: Where did the matter come from in the first place?<sup>42</sup>

What about the question of star light? To the astrophysicist, the universe looks very old. Traveling at incredible speed (186,000 miles per second), light we see today from distant stars had to travel millions or billions

of years to get here. But if the universe is only a few thousand years old, how would light have time to reach us?

This problem can be resolved when one considers the law of general relativity discovered by Albert Einstein. One element of this law says that time is affected by gravity. In places of high gravity, time slows down. But in places of little or no gravity, time speeds up significantly. A clock on earth (high gravity) ticks more slowly than a clock in outer space (no gravity).

If earth is near the center of an expanding universe (the Bible says in several places that God “stretched out the heavens”), then the gravitational effects on time will mean that in a few earth days, millions of years may have elapsed in the outer parts of the universe. It might thus *appear* that it has taken billions of years for light to reach us from distant galaxies, but this would not be the case in earth’s framework of time.<sup>43</sup>

#### BIG BUST!

Many scientists do not find sufficient evidence to support the big-bang theory. They judge its logic absurd and probability impossible. Some of them writing for certain biased textbooks are compelled to “agree” with the theory to support the philosophical bias of their publisher, but in reality the scientists themselves couldn’t be more diametrically opposed.

Lemonick and Nash quote some authorities’ misgivings with the big bang theory:

“If we really trust the data,” exclaims Stanford astrophysicist Andrei Linde, “then we are in disaster, and we must do something absolutely crazy. But this hasn’t stopped the theorists from doing crazy things anyway; they’ve proposed one mind-stretching idea after another to explain what’s going on.”<sup>44</sup>

Leslie, an author and scientist, agrees that the logic is missing, saying:

It is hard to see how galaxies could have formed in a universe which is flying apart so fast.<sup>45</sup>

Sir Fredrick Hoyle, British astronomer, nails the coffin shut on the big-bang theory:

An explosion merely throws matter apart, while the big bang has mysteriously produced the opposite effect, with matter clumping together in the form of galaxies.<sup>46</sup>

Hoyle also adds:

The notion that galaxies form, to be followed by an active astronomical history, is an illusion. Nothing forms; the thing (the big-bang theory) is dead as a doornail.<sup>47</sup>

Renowned cosmologist John Gribbin expresses the conclusion of many others:

Many cosmologists now feel that the shortcomings of the standard (big-bang) theory outweigh its usefulness.<sup>48</sup>

Any unbiased individual can tell you that explosives always produce chaos — not systems of extremely well-ordered, well-designed complexities like galaxies and solar systems. This fact led British astronomer Paul Davies to write:

The greatest puzzle is where all the order in the universe came from originally.<sup>49</sup>

Davies, in a *New Scientist* journal article, continues to explain:

Everywhere we look in the universe, from the far-flung galaxies to the deepest recesses of the atom, we encounter order.<sup>50</sup>

Einstein also agreed, suggesting that the “high degree of order” was somewhat of a “miracle.”<sup>51</sup>

The big-bang theory is a big bust. What, then, is the most reasonable explanation for the complex structure of our universe? The only possible explanation is this: The universe must have been designed and created that way!

#### IT'S ABOUT TIME!

How old is planet Earth? The question is essential. For evolution to be true requires an inhabitable planet “billions of years old” (actually, on the order of trillions of years old!) to give enough time for life to emerge and develop. Any time less, and evolution is impossible to support.

Everett Koop, former U.S. Surgeon General, vividly describes the challenge:

When I make an incision with my scalpel, I see organs of such intricacy that there simply hasn't been enough time for natural evolutionary processes to have developed them.<sup>52</sup>

A great temptation faced by evolutionists is to stretch logic to the near breaking point, assigning vast ages to fossils and other artifacts, when the scientific evidence is contrary. It's a very hard fact to confess, but more and more evolutionists are admitting the truth about our young earth.

Dr. Harold Slusher, an astrophysicist and geophysicist, says:

There are a number of indicators that seem to indicate an age of no more than 10,000 years, at the very most, for the solar system and the earth.<sup>53</sup>

#### SUMMING UP

An ancient, inhabitable earth is an absolute requirement for evolution to have time to occur. We've been taught that sedimentary rock indicates an old planet. Today, however, we know that sedimentary rock can actually form very quickly. A great worldwide flood can certainly explain many features we find in geology.

Radiometric dating, long considered a gold standard, is actually a flawed and unreliable technique. For accuracy, it requires information about the ancient world that we have no way of knowing today. Many other methods of estimating the earth's age — from studying our magnetic fields to world population growth — point toward a very young planet.

What's more, evidence for the big bang, another cornerstone of the ancient earth idea, is shaky and contradicts the laws of physics. The order displayed by the universe could not possibly result from a massive explosion.

Contrary to what is commonly taught, the earth is not four to five billion years old. Scientific evidence actually supports a planet on the order of only six to ten thousand years old, far too young for evolution to have any chance to occur.

51 Albert Einstein, *Letters à Maurice Solovine* (Paris: Gauthier-Villars, 1956), p. 115.

52 Taylor, *Origins Answer Book*, p. 18–20.

53 Glashouwer and Taylor, “The Earth, a Young Planet?” quoting Harold S. Slusher.

## ENDNOTES

- 1 R.E. Walsh, editor, *Proceedings of the First International Conference on Creationism*, "Mount St. Helens and Catastrophism," by Stephen Austin (Pittsburgh, PA: Creation Science Fellowship, 1986).
- 2 P. Julien, Y. Lan, and G. Berthault, "Experiments on Stratification of Heterogeneous Sand Mixtures," *Creation Ex Nihilo Technical Journal*, 8(1):3750 (1994).  
H.A. Makse, S. Havlin, P.R. King, H.E. Stanley, "Spontaneous Stratification in Granular Mixtures," *Nature*, 386(6623):379-382 (March 27, 1997).
- 3 Carl Wieland, *Stones and Bones* (Green Forest, AR: Master Books, Inc., 1994).
- 4 *Ibid.*
- 5 R.A. Kerr, "Pathfinder Tells a Geologic Tale with One Starring Role," *Science*, 279(5348):175 (January 9, 1998).
- 6 R.H. Rastall (lecturer in economic geology, Cambridge University), *Encyclopedia Britannica* (1956), Vol. 10, p. 168.
- 7 J.E. O'Rourke, *American Journal of Science*, vol. 276 (January 1976): p. 53.
- 8 Niles Eldredge (American Museum of Natural History, New York), *Time Frames: The Rethinking of Darwinian Evolution and the Theory of Punctuated Equilibria* (New York, NY: Simon and Schuster, 1985 and London: William Heinemann, Ltd, 1986), p. 52.
- 9 Bert Thompson, *The Global Flood of Noah* (Montgomery, AL: Apologetics Press, 1986), p. 34-35.
- 10 *Ibid.*, p. 44-45.
- 11 Byron Nelson, *The Deluge Story in Stone* (Minneapolis, MN: Augsburg Publishing House, 1968), p. 66 and 85.
- 12 J. William Dawson, *The Historical Deluge in Relation to Scientific Discovery*, p. 4ff.
- 13 Thompson, *The Global Flood of Noah*, p. 13-14.
- 14 *Los Angeles Herald Examiner*, January 7, 1970.
- 15 Frederic B. Jueneman, "Secular Catastrophism," *Industrial Research and Development* (June 1982): p. 21.
- 16 Jackson, *Creation, Evolution, and the Age of the Earth*, p. 8-9.
- 17 A.A. Snelling, "Radiometric Dating in Conflict," *Creation*, 20(1):24-27 (December 1997-February 1998).
- 18 A.A. Snelling, "Stumping Old-Age Dogma," *Creation*, 20(4):48-50 (September/November 1998).
- 19 S.A. Austin, "Excess Argon within Mineral Concentrates from the New Dacite Lava Dome at Mount St. Helens Volcano," *Creation Ex Nihilo Technical Journal*, 10(3):335343 (1986).
- 20 E. Walsh, editor, *Proceedings of the Fourth International Conference on Creationism*, "The Cause of Anomalous Potassium-Argon 'Ages' for Recent Andesite Flows at Mt. Ngauruhoe, New Zealand, and the Implications for Potassium-Argon 'Dating,'" by A.A. Snelling (Pittsburgh, PA: Creation Science Fellowship, 1998), p. 503-525.
- 21 Wakefield Dort Jr., "Mummified Seals of Southern Victoria Land," *Antarctic Journal* (Washington), vol. 6 (September-October 1971), p. 211.
- 22 William J.J. Glashouwer and Paul S. Taylor, "The Earth, a Young Planet," a film produced by Eden Communications, Gilbert, AZ, 1983.
- 23 Alan C. Riggs, "Major Carbon-14 Deficiency in Modern Snail Shells from Southern Nevada Springs," *Science*, vol. 224 (April 6, 1984): p. 58.
- 24 William D. Stansfield, *The Science of Evolution* (New York, NY: MacMillan, 1977), p. 82, 84.
- 25 Richard L. Mauger, "K-Ar Ages of Biotites from Tuffs in Eocene Rocks of the Green River, Washakie, and Uinta Basins, Utah, Wyoming, and Colorado," *Contributions to Geology*, University of Wyoming, vol. 15(1), (1977): p. 37
- 26 Robert E. Lee, "Radiocarbon: Ages in Error," *Anthropological Journal of Canada*, vol. 19(3), (1981): p. 9-29.
- 27 Glashouwer and Taylor, "The Earth, A Young Planet?" quoting Thomas Barnes.
- 28 R.E. Walsh, editor, *Proceedings of the First International Conference on Creationism*, "Reversals of the Earth's Magnetic Field During the Genesis Flood," by D.R. Humphreys (Pittsburgh, PA: Creation Science Fellowship, 1986), Vol. 2, p. 113-126.  
J.D. Sarfati, "The Earth's Magnetic Field: Evidence That the Earth Is Young," *Creation*, 20(2):15-19 (March-May 1998).
- 29 R.E. Walsh, editor, *Proceedings of the Second International Conference on Creationism*, "The Sea's Missing Salt: A Dilemma for Evolutionists," by S.A. Austin and D.R. Humphreys (Pittsburgh, PA: The Fellowship, 1990), Vol. 2, p. 17-33.  
J.D. Sarfati, "Salty Seas: Evidence for a Young Earth," *Creation*, 21(1):16-17 (December 1998-February 1999).
- 30 C. Wieland, "Sensational Dinosaur Blood Report!" *Creation*, 19(4):42-43 (September-November 1997).  
M. Schweitzer and T. Staedter, "The Real Jurassic Park," *Earth* (June 1997): p. 55-57.
- 31 R.E. Walsh, editor, *Proceedings of the Third International Conference on Creationism*, "Distribution of Supernova Remnants in the Galaxy," by K. Davies (Pittsburgh, PA: The Fellowship 1994), p. 175-184.  
J.D. Sarfati, "Exploding Stars Point to a Young Universe," *Creation*, 19(3):46-49 (June-August 1998).
- 32 L. Vardiman, *The Age of the Earth's Atmosphere: A Study of the Helium Flux through the Atmosphere* (El Cajon, CA: Institute for Creation Research, 1990).  
J.D. Sarfati, "Blowing Old-Earth Belief Away: Helium Gives Evidence That the Earth Is Young," *Creation*, 20(3):19-21 (June-August 1998).
- 33 Don DeYoung, *Creation Ex Nihilo*, 14(4)43 (September-November 1992).
- 34 W.H. Twenhofel, *Principles of Sedimentation* (New York, NY: McGraw-Hill, 1950), second edition, p. 144.  
Walter T. Brown Jr., *In The Beginning* (Phoenix, AZ: Center for Scientific Creation, 1989), p. 53.
- 35 John Maddox, "Halley's Comet Is Quite Young," *Nature*, vol. 339 (May 11, 1989).
- 36 *Science* (August 16, 1963).
- 37 Taylor, *Origins Answer Book*, p. 68-69.
- 38 Steven Austin, "Mount St. Helens and Catastrophism," *Impact*, July 1986.
- 39 Taylor, *Origins Answer Book*, p. 69.  
Paul D. Ackerman, *It's a Young World After All* (Grand Rapids, MI: Baker Book House, 1986).
- 40 Margaret Bishop, *Focus on Earth Science*, teacher's edition (Columbia, OH: Merrill, 1981), p. 470.
- 41 John Billingham and Rudolf Pe, editors, *Communications With Extra-Terrestrial Intelligence* (New York, NY: Pergamon Press, 1973).
- 42 Konrad B. Krauskopf and Arthur Beiser, *The Physical Universe* (New York, NY: McGraw-Hill, 1973), third edition, p. 645.
- 43 D. Russell Humphreys, *Starlight and Time* (Green Forest, AR: Master Books, 1994).
- 44 Michael D. Lemonick and J. Madeleine Nash, "Unraveling Universe," *Time* (March 6, 1995): p. 78.
- 45 N. Rescher, editor, *Scientific Explanation and Understanding*, "Cosmology, Probability, and the Need to Explain Life," by Leslie (Lanham, MD: University Press of America, 1983), p. 54.
- 46 Sir Fred Hoyle, *The Intelligent Universe* (New York, NY: Holt, Rinehart & Winston, 1983), p. 185.
- 47 Bert Thompson, *Cosmic Evolution and the Origin of Life* (Montgomery, AL: Apologetics Press, Inc., 1989), p. 7.
- 48 *Ibid.*, p. 5, quoting John Gribbin, "Cosmologists Move Beyond the Big Bang," *New Scientist*, vol. 110, p. 30.
- 49 P. Davies, "Universe in Reverse — Can Time Run Backwards?" *Second Look* (Sept. 1979): p. 27.
- 50 Davies, "Chance or Choice: Is the Universe an Accident?" *New Scientist*, vol. 80 (1978): p. 506.

51 See p. 75g bottom

# THE BEREAN CALL

P.O. Box 7019 Bend, Oregon 97708

February 1997

## Evolution or God's Word?

Dave Hunt

Most non-Catholics were surprised when Pope John Paul II, in a paper to the Vatican's Pontifical Academy of Sciences October 23, 1996, spoke in favor of evolution. But in fact, he only reiterated Catholicism's official position. Consider these excerpts:

In his Encyclical *Humani generis* (1950), my predecessor Pius XII had already stated that there was no opposition between evolution and the doctrine of the faith about man.... Pius XII stressed this essential point: if the human body takes its origin from pre-existent living matter, the spiritual soul is immediately created by God....[T]he exegete and the theologian must keep informed about...the natural sciences...truth cannot contradict truth....

[T]he theory of evolution...has been progressively accepted by researchers, following a series of discoveries in various fields of knowledge. The convergence...of the results of work that was conducted independently is in itself a significant argument in favour of this theory.<sup>1</sup>

No doubt the embarrassing fiasco of Galileo's trial was in mind when the Pope warned Church theologians to "keep informed about...the natural sciences..." Pope Urban VIII threatened an elderly and very ill Galileo with torture if he would not renounce his claim that the earth revolved around the sun. On his knees before Rome's Holy Office of the Inquisition, in fear for his life, Galileo recanted of this "heresy"—but not in his heart. That the sun and all heavenly bodies revolved around the earth remained official Catholic dogma, repeatedly affirmed by "infallible" popes until 1992, when the Vatican at last admitted officially that Galileo had been right.

Lest science continue to make fools of the "infallible" Church hierarchy, the Pope cautions Catholic theologians to check with scientists before interpreting Scripture. Yet Peter, whom Catholics say was the first pope, declared that Scripture is inspired of the Holy Spirit (2 Pt 1:21). Surely the Holy Spirit needs no help from scientists! If the Bible is not infallible when it speaks to science, then why trust it regarding God or salvation? Edward Daschbach, a Catholic priest, explains that to take the Bible literally would require admitting that the woman on

the beast in Revelation 17 is the Roman Catholic Church! He writes,

The Church, then, does not accept...the literal interpretation of the opening chapters of the Book of Genesis....When creation-science advocates ply their fundamentalist tools to this final scriptural book [Revelation], the Church often becomes a target for vehement attack....<sup>2</sup>

Evangelicals such as Chuck Colson who have joined forces with Rome claim that Catholicism agrees with them on biblical inerrancy. On the contrary, Vatican II declares, "Hence the Bible is free from error in what pertains to religious truth revealed for our salvation. It is not necessarily free from error in other matters (e.g., natural science)" [Emphasis in original].<sup>3</sup>

This is no light matter. If the Genesis account of creation isn't reliable, then neither is the remainder of the Bible, which rests upon it; and Christ is proven not to be

**All scripture is given by  
inspiration of God...**

*2 Timothy 3:16*

God but a mere man who foolishly took the story of Adam and Eve literally (Mt 19:4-5) and could not be our Savior. *The American Atheist* knows the issues: "Destroy Adam and Eve and original sin, and in the rubble you will find the sorry remains of the Son of God and take away the meaning of his death."<sup>4</sup>

In May, 1982, honoring Charles Darwin on the 100th anniversary of his death, the Vatican's Pontifical Academy of Sciences issued this statement: "[M]asses of evidence render the application of the concept of evolution...beyond serious dispute."<sup>5</sup> The *New Catholic Encyclopedia* says,

[S]pecialists...over a period of 100 years, have assembled the necessary evidence...evolution has been established as thoroughly as science can establish facts....<sup>6</sup>

Not so. Growing numbers of even non-Christian scientists oppose evolution. Astronomer/mathematician Sir Fred Hoyle says, "The scientific world has been bamboozled into believing that evolution has

been proved. Nothing could be further from the truth."<sup>7</sup> Biologist Michael Denton, author of *Evolution: A Theory in Crisis*, says science has so thoroughly discredited Darwinian evolution that it should be discarded. Mathematics professor Wolfgang Smith calls evolution "a metaphysical myth...totally bereft of scientific sanction..."<sup>8</sup>

Colin Patterson, senior paleontologist at the British Museum of Natural History, confessed, after more than 20 years' involvement, "[T]here was not one thing I knew about it. It's quite a shock to learn that one can be misled for so long." Patterson "started asking other scientists to tell him *one thing* they knew about evolution." Biologists at the American Museum of Natural History in New York were speechless. Says Patterson:

I tried that question on the geology staff at the Field Museum of Natural History and the only answer I got was silence. I tried it on the members of the Evolutionary Morphology Seminar in the University of Chicago, a very prestigious body of evolutionists, and all I got there was silence for a long time and eventually one person said, "I do know one thing—it ought not to be taught in high school."<sup>9</sup>

Notwithstanding, in *Edwards v. Aguillard*, 482 U.S. 578 (1978), the Supreme Court ruled it unconstitutional for public schools to teach creationism even as a theory alongside of Darwinism. Evangelicals rightly complain about evolution being taught as fact in public schools, yet it is also taught as fact in Catholic schools.<sup>10</sup> In *The Catholic World Report*, Stephen F. Smith writes, "[I]n Catholic school here in the Archdiocese of Washington, DC, we were taught that Charles Darwin's theory of evolution was gospel truth."<sup>11</sup> Biochemist Michael Behe says of his days in Catholic schools,

I...[was taught] life...came from God, and...the leading scientific explanation for how He did it was Darwin's theory of evolution. I...saw no conflict with Church teaching.<sup>12</sup>

In his book, *The Blind Watchmaker*, Oxford University zoologist Richard Dawkins, a leading evolutionist, calls biology "the study of complicated things that give the appearance of having been designed for a purpose."<sup>13</sup> Indeed! One cell, the smallest living unit, could have



## Evolution or God's Word? (2 of 2)

Dave Hunt, "The Berean Call" PO Box 7019 Bend, Oregon, 97708 USA (February 1997)

100,000 molecules and 10,000 intricately interrelated chemical reactions going on at one time. Cells couldn't arise by chance! Dawkins admits that every cell contains in its nucleus "a digitally coded database larger...than all 30 volumes of the Encyclopedia Britannica put together."<sup>14</sup> You can't even imagine the odds against chance creating a 30-volume encyclopedia! That's for *one* cell—and there are trillions in the human body, thousands of different kinds, working in unbelievably complex and delicately balanced relationships!

The astronomical odds make evolution mathematically impossible. Hoyle calculated that the odds of producing *just the basic enzymes* of life by chance are 1 over 1 with 40,000 zeros after it. By comparison, the odds of plucking a particular atom out of the universe is 1 over 1 with 80 zeros. Even if each atom became another universe, the odds of plucking a particular atom out of all those universes by chance are 1 over 1 with 160 zeros. One chance in 1 with 40,000 zeros after it just to produce the basic enzymes! But enzymes perform incredible feats, which fact further compounds the already impossible odds.

Why does blood clot only at the point of bleeding and not within the veins and arteries—and stop clotting when the bleeding stops? Imagine the billions of animals that would have bled to death or been killed by improper blood clotting before this incredible process was perfected *by chance!* The immune system is even more astonishing, says Behe: "The complexity of the system dooms all Darwinian explanations..."<sup>15</sup> And so it is with hundreds of other life systems. Remember, these complex systems must be *operational* to be of value; they couldn't evolve in stages.

In his excellent 1996 book, *Darwin's Black Box* (offered this month), Behe documents the incomprehensible complexity of life at its most basic chemical/cellular level—a complexity unimagined by Darwin. Behe, who says evolution "should be banished,"<sup>16</sup> demolishes Darwin's theory by offering multiple examples at the biochemical level of intricately designed "irreducibly complex" elements which *could not have evolved*:

[Evolution] cannot explain the origin of the complex biochemical structures that undergird life. It doesn't even try...The conclusion of intelligent design flows naturally from the data itself—not from sacred books or sectarian beliefs.<sup>17</sup>

In support of the Pope, Donald Devine writes, "Prehuman man apparently existed for millions of years....This is not a refutation of the Bible but a confirmation of it—that it took God to breathe in a soul before man could be man."<sup>18</sup> On the contrary! Theistic

evolution, by requiring prehuman ancestors of man (for whom no evidence has ever been found), contradicts not only Genesis but the entire Bible.

Moses says that God formed Adam from "the dust of the ground," then *later* formed Eve from "one of his ribs" (Gn 2:7,18-22). Prehuman ancestors cannot be reconciled with that account, an account authenticated by Jesus: "Have ye not read, that he which made them in the beginning made them male and female, and said, For this cause shall a man leave his father and mother, and shall cleave to his wife; and they twain shall be one flesh?" (Mt 19:4-5). Christ confirms the Genesis account by quoting from it. Paul, too, attested to its accuracy when he declared that "Adam was first formed, then Eve" (1 Tm 2:13-14—see also 1 Cor 15:22, 45; Jude 14). They were not a pair of prehuman creatures into whom God infused human souls.

**Making the word of God of none effect through your tradition...**

*Mark 7:13*

Furthermore, Paul says that sin entered the world through Adam, and *death by sin* (Rom 5:12). If Adam and Eve had ancestors who had lived and died during thousands (or millions) of years of evolution until God humanized them, death would have operated on earth before Adam sinned—a clear contradiction of Genesis, of Christ's teaching, of Paul's preaching and of the gospel. (New York's Cardinal O'Connor says Adam and Eve may have been "lower animals."<sup>19</sup>)

Evolution, this "most bloated of sacred cows,"<sup>20</sup> has been a powerful tool of Satan to persuade millions that the Bible isn't reliable. As Berkeley law professor Phillip Johnson puts it, "The whole purpose of the Darwinian evolutionary story is to...show that you don't need a preexisting intelligence...[for] creation."<sup>21</sup> Johnson shocked the academic world in 1991 with his book, *Darwin on Trial*. With the precision of a trial lawyer, he destroyed Darwinism and indicted evolutionists with having "abandoned the truthful and accurate reporting to which science has traditionally been committed in their zeal to extirpate and dismiss religion..."<sup>22</sup>

Evolution would have filled the fossil record with billions of intermediary creatures, yet *not one* of these "missing links" has been found! Imagine the debris of the millions of tiny increments over millions of years it must have taken to develop lungs from gills, wings from nothing, the stomach and digestive system, eyes,

kidneys, the brain and nervous system throughout the body, the blood stream, sperm and ovum for mammals, the egg and its shell for birds and reptiles, etc. Impossibility is compounded since each of these systems is incredibly complex and could not gradually evolve, but must be fully functional to sustain life and aid in "survival"—for example, the bat's sophisticated radar system.

How many millions of Arctic terns drowned before the first one "learned," *by chance*, to navigate thousands of miles across the ocean? How many salmon lost their way and never made it back to their birth stream to spawn before this uncanny ability was developed? How many spiders starved before the amazing mechanism for making webs *chanced* itself into existence—and who taught spiders to use this contrivance? How many eggs of all manner of birds rotted before the instinct to hatch eggs developed? How was it learned and passed on? There are countless impossibilities for "chance."

Today's concern for "endangered species" contradicts Darwin. Evolution wipes out the unfit. One cannot believe in evolution and also work for ecological preservation of species. As evolution's ultimate product, man should mercilessly stamp out every rival for survival. The contradictions are endless.

In his latest book, *Reason in the Balance*, Phillip Johnson argues that only creation by God can account for man's moral conscience. Nature has no morals. Man's sense of ethics and morals disproves evolution. If evolution is true, we ought to shut down all hospitals, cease all medications and let the weak die. You can't reconcile kindness and compassion with evolution's survival of the fittest.

But man is compelled by conscience and compassion, proof that he is made in the image of a God of holiness and love. By rejecting the overwhelming evidence of design in the world about him (Rom 1:18-32), and by refusing to obey God's laws inscribed in his conscience (Rom 2:14-15), man has fallen victim to his own ego and to all manner of evil. Nevertheless, God loves man, and in love and grace He came to this earth through the virgin birth so that, as the perfect, sinless man, He could die in our place, paying the infinite penalty His own justice demanded for sin. It is on this basis alone—Christ's full payment of sin's penalty and man's acceptance of that payment—that man can become a new creation in Christ. Let us stand true to this gospel of Jesus Christ and to God's Word which declares it; and let us stand firm against every attempted dilution, perversion or compromise of God's truth! **TBC**

## Affirmations and Denials

### Essential to a Consistent Christian (Biblical) Worldview

The following affirmations and denials reflect the almost universal consensus of the church throughout history, until the early 19th century. Their substance, rigorously defended by many past and present scholars, is currently rejected by a large portion of the contemporary worldwide church and, sadly, by many Christian scholars involved in explaining and defending the Christian worldview. Therefore, as an addendum to the affirmations and denials of the International Council on Biblical Inerrancy and of the International Church Council, the undersigned present these affirmations and denials to the Church as an essential part of the presentation of the Christian worldview to the world of the 21st century. If you agree and want to add your name to the list of signatories, follow the instructions at the end of this document.

1. We affirm that the scientific aspects of creation are important, but are secondary in importance to the proclamation of the gospel of Jesus Christ as Sovereign, Creator, Redeemer and Judge.

We deny that the doctrines of Creator and Creation can ultimately be divorced from the gospel of Jesus Christ, for the teachings of Genesis are foundational to the gospel and indeed to all Biblical doctrines (directly or indirectly).

2. We affirm that the 66 books of the Bible are the written Word of God. The Bible is divinely inspired and inerrant throughout. Its assertions are factually true in all the original autographs. It is the supreme authority, not only in all matters of faith and conduct, but in everything that it teaches.

We deny that the Bible's authority is limited to spiritual, religious or redemptive themes and we deny the exclusion of its authority from its assertions related to such fields as history and science.

3. We affirm that the final guide to the interpretation of Scripture is Scripture itself. Scripture must be compared with Scripture to obtain the correct interpretation of a particular text, and clear Scriptures must be used to interpret ambiguous texts, not vice versa. We affirm that the special revelation of infallible and inerrant Scripture must be used to correctly interpret the general revelation of the cursed Creation.

We deny that uninspired sources of truth-claims (i.e., history, archeology, science, etc.) can be used to interpret the Scriptures to mean something other than the meaning obtained by classical historical-grammatical exegesis. We further deny the view, commonly used to evade the implications or the authority of Biblical teaching, that Biblical truth and scientific truth must remain totally exclusive from each other and that science could never agree with the Bible.

4. We affirm that no apparent, perceived, or claimed evidence in any field, including history, archeology and science, can be considered valid if it contradicts the Scriptural record. We also affirm that the evidence from such fields of inquiry is always subject to interpretation by fallible people who do not possess all information.

We deny that scientific "evidence" used to "prove" millions of years is objective fact and not heavily influenced by naturalistic presuppositions.

5. We affirm that the account of origins presented in Genesis is a simple but factual presentation of actual events and therefore provides a reliable framework for scientific research into the question of the origin and history of life, mankind, the Earth and the universe.

We deny that Genesis 1–11 is myth, saga, or any other type of non-historical literature. We also deny that it is a parable or prophetic vision. It therefore should be interpreted with the same care for literal accuracy as other historical narrative sections of Scripture in, for example, Joshua, Judges, 1 & 2 Kings, the Gospels, and Acts.

6. We affirm that the genealogies in Genesis 5 and 11 are chronological, enabling us to arrive at an approximate date of creation of the whole universe. We affirm that mankind is essentially as old as the whole creation. While some disagreement exists between young-earth creationists over whether or not these are strict, gap-less genealogies (i.e., no missing names between Adam and Noah and Noah and Abraham), we affirm that Genesis points to a date of creation between about 6,000–10,000 years ago.

We deny that millions of years of history occurred before Adam and Eve. Therefore we deny that the geological record of strata and fossils corresponds to long geological ages before man. We also deny the Big Bang and any other naturalistic theory of the origin and history of the universe. We further deny that the radiometric dating methods, which are claimed to give dates of millions of years, are trustworthy and can be used to overthrow or disregard the Biblical teaching on the age of the creation. We further deny that the Egyptian, Chinese, or other pagan chronologies are more reliable than the Bible's chronological statements and we deny that those pagan chronologies can be used to overrule the careful exegesis of the relevant Biblical texts regarding the age of the earth and other Old Testament events.

7. We affirm that the days in Genesis do not correspond to geologic ages, but are six, consecutive, literal (essentially twenty-four hour) days of Creation.

We deny that the days of creation are symbolic of long ages or that millions of years can be placed between the days or before the six days of creation.

8. We affirm that the various original life forms (kinds), including mankind, were made by direct, supernatural, creative acts of God. The living descendants of any of the original kinds (apart from man) may represent more than one species today, reflecting the genetic potential within a particular original created kind. Only relatively limited biological changes (due to such processes as natural selection, mutations, and other biological processes that might be discovered in the future) have occurred naturally within each kind since Creation.

We deny that there has ever been any evolutionary change from one of the original created kinds into a different kind (e.g., fish to amphibian, reptile to mammal, reptile to bird, ape to man, or land mammal to whale, etc.).

9. We affirm the supernatural creation of Adam from dust and the supernatural creation of Eve from Adam's rib in a very short period of time (seconds or minutes) on the sixth day of Creation.

We deny that Adam was in any way made from a pre-existing hominid (or any other living creature). We further deny the existence of any creatures which looked or acted like man but which did not possess a soul. We deny also that categories of creatures such as "Neanderthal Man" and "Cro-Magnon Man" were pre- or sub-human (rather than being fully human descendants of Adam).

10. We affirm that the account of the Fall of Adam and Eve into sin is a literal historical account and that the Fall had cosmic consequences. We also affirm that both physical and spiritual death and bloodshed entered into this world subsequent to, and as a direct consequence of, man's sin. We further affirm that this historical Fall is the reason for the necessity of salvation for mankind through the redemptive work of the "last Adam," Jesus Christ.

We deny that the account of the Fall was mythical, figurative, or otherwise largely symbolic. While certain aspects of Genesis 1–11 are typological with reference to the work of Christ, we deny that this in anyway negates or eliminates the literal historicity of the text. We deny that the judgment of God at the Fall resulted only in the spiritual death of man or only consequences for man but not for the rest of animate and inanimate creation. We, therefore, also deny that millions of years of death, disease, violence, and extinction occurred in the animal world before the Fall and thereby deny that those millions of years claimed by the evolutionary scientific establishment ever happened.

11. We affirm that the great Flood described in Genesis 6–9 was an actual historic event, worldwide (global) in its extent and extremely catastrophic in its effect. As such, it produced most (but not all) of the geological record of thousands of meters of strata and fossils that we see on the earth's surface today.

We deny that Noah's Flood was limited to a localized region (e.g., the Mesopotamian valley of the Tigris and Euphrates Rivers). We also deny that the Flood was so peaceful that it left no abiding geological evidence. We further deny that the thousands of meters of sedimentary rock formations with their fossilized remains were largely produced after or before the Flood or even before Adam.

12. We affirm that all people living and dead are descended from Adam and Eve and that as such all people equally bear the image of God, their Maker. We, therefore, affirm that there is only one race of human beings and that the various people groups (with their various languages, cultures, and distinctive physical characteristics, including skin color) arose as a result of God's supernatural judgment at the Tower of Babel and the subsequent dispersion of the people by families.

We deny that the so-called "races" have different origins and that any one "race" is superior to any other.

We, the undersigned, call on the Church to embrace these affirmations and denials as they are explicitly taught or implied by Holy Scripture and are consistent with the historic belief of the Church prior to the rise of old-earth ("deep time") theories in geology and astronomy in the late 18th and early 19th centuries and evolutionary theories since that time.

### Original Signatories

Terry Mortenson, Ph.D.  
Answers in Genesis  
Hebron, KY, USA

William Barrick, Th.D.  
The Master's Seminary  
Sun Valley, CA, USA

Trevor Craigen, Th.D.  
The Master's Seminary  
Sun Valley, CA, USA

John MacArthur, D.D.  
Grace Community Church  
Sun Valley, CA, USA

Robert McCabe, Th.D.  
Detroit Baptist Theological Seminary  
Detroit, MI, USA

Paul Scharf, M.Div.  
Whitcomb Ministries  
Indianapolis, IN, USA

Todd Beall, Ph.D.  
Capital Bible Seminary  
Lanham, MD, USA

David W. Hall, Ph.D.  
Midway Presbyterian Church  
Powder Springs, GA, USA

Thane H. Ury, Ph.D.  
United Wesleyan Graduate Institute  
HONG KONG

Richard Mayhue, Th.D.  
The Master's Seminary  
Sun Valley, CA, USA

Ron Minton, Th.D.  
Missionary  
UKRAINE

John Whitcomb, Th.D.  
Whitcomb Ministries  
Indianapolis, IN, USA

James Mook, Th.D.  
Capital Bible Seminary  
Lanham, MD, USA

Travis R. Freeman, Ph.D.  
Baptist College of Florida  
Graceville, FL, USA

James Stambaugh, Ph.D. candidate  
Baptist Bible Seminary  
Clarks Summit, PA, USA

Steven W. Boyd, Ph.D.  
The Master's College  
Santa Clarita, CA, USA

Document Found at:  
<http://answersingenesis.org/articles/affirmations-denials-christian-worldview>

I also signed this document on 12 Feb 09

# The Evolution of Man:

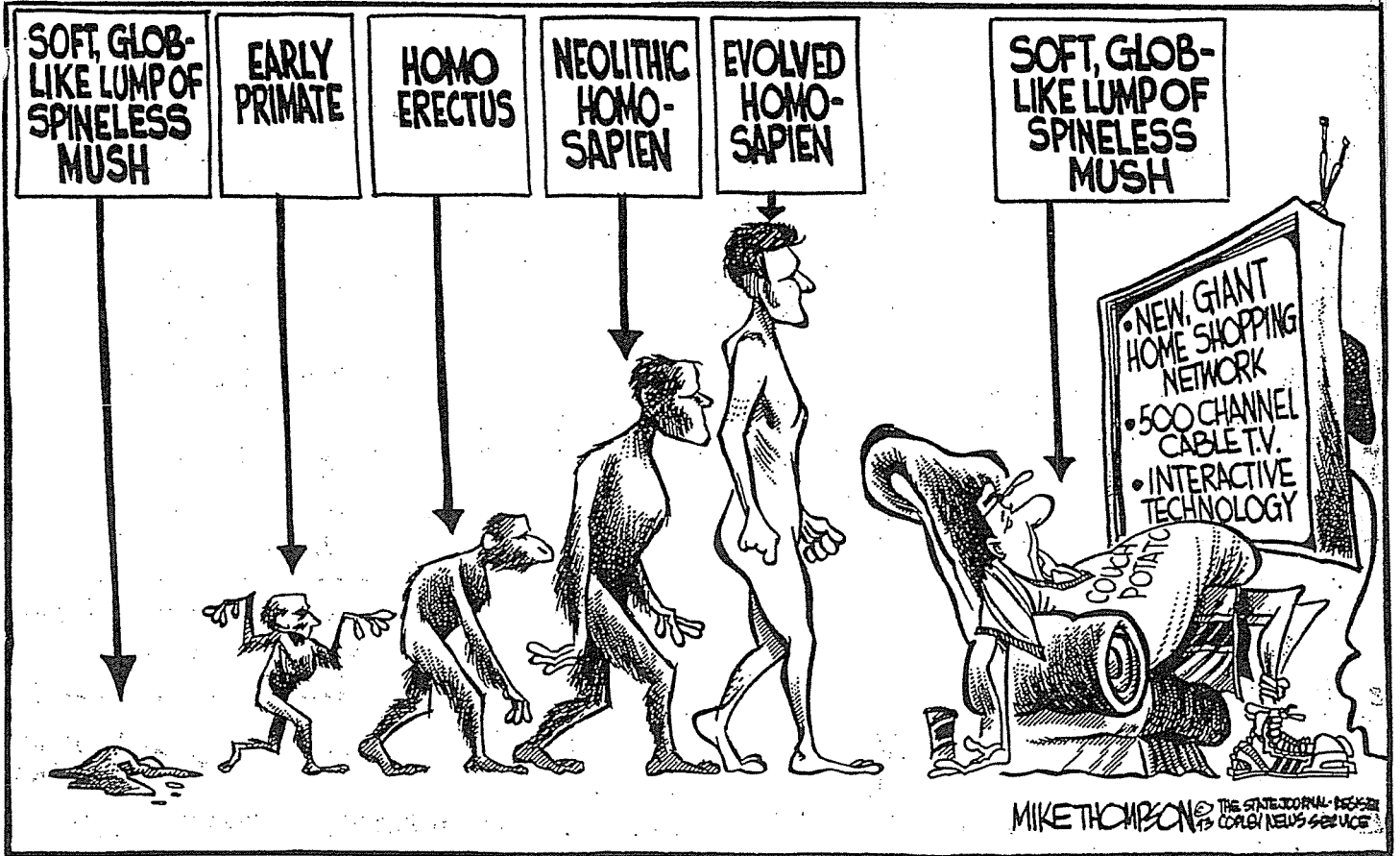

## Chapter 12: What's Wrong with Progressive Creation?

by Ken Ham & Dr. Terry Mortenson

April 29, 2010

<http://www.answersingenesis.org/articles/nab2/whats-wrong-with-progressive-creation>

Layman

### Keywords

- [author-ken-ham](#)
- [author-terry-mortenson](#)
- [creation-compromises](#)
- [hugh-ross](#)
- [nab2](#)
- [progressive-creation](#)
- [the-flood](#)

### Featured In

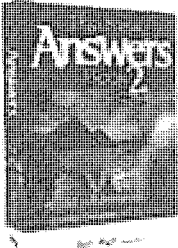

- [Browse this title](#)
- [Buy this title](#)

One result of compromising with our evolutionary culture is the view of creation called the “day-age” theory or “progressive creation.” This view, while not a new one, has received wide publicity in the past several years. Much of this publicity is due to the publications and lectures of astronomer Dr. Hugh Ross — probably the world’s leading progressive creationist. Dr. Ross’s views on how to interpret the Book of Genesis won early endorsements from many well-known Christian leaders, churches, seminaries, and Christian colleges. The teachings of Dr. Ross seemingly allowed Christians to use the term “creationist” but still gave them supposed academic respectability in the eyes of the world by rejecting six literal days of creation and maintaining billions of years. However, after his views became more fully understood, many who had previously embraced progressive creation realized how bankrupt those views are and removed their endorsement.

In this chapter, some of the teachings of progressive creation will be examined in light of Scripture and good science.<sup>1</sup>

### In Summary, Progressive Creation Teaches:

- The big-bang origin of the universe occurred about 13–15 billion years ago.
- The days of creation were overlapping periods of millions and billions of years.
- Over millions of years, God created new species as others kept going extinct.
- The record of nature is just as reliable as the Word of God.
- Death, bloodshed, and disease existed before Adam and Eve.
- Manlike creatures that looked and behaved much like us (and painted on cave walls) existed before Adam and Eve but did not have a spirit that was made in the image of God, and thus had no hope of salvation.
- The Genesis Flood was a local event.

### The Big Bang Origin of the Universe

Progressive creation teaches that the modern big-bang theory of the origin of the universe is true and has been proven by scientific inquiry and observation. For Hugh Ross and others like him, big-bang cosmology becomes the basis by which the Bible is interpreted. This includes belief that the universe and the earth are billions of years old. Dr. Ross even goes so far as to state that life would not be possible on earth without billions of years of earth history:

It only works in a cosmos of a hundred-billion trillion stars that’s precisely sixteen-billion-years old. This is the narrow window of time in which life is possible.<sup>2</sup>

Life is only possible when the universe is between 12 and 17 billion years.<sup>3</sup>

This, of course, ignores the fact that God is omnipotent—He could make a fully functional universe ready for life right from the beginning, for with God nothing is impossible (*Matthew 19:26*).<sup>4</sup>

## The Days of Creation in Genesis 1

Progressive creationists claim that the days of creation in Genesis 1 represent long periods of time. In fact, Dr. Ross believes day 3 of creation week lasted more than 3 billion years!<sup>5</sup> This assertion is made in order to allow for the billions of years that evolutionists claim are represented in the rock layers of earth. This position, however, has problems, both biblically and scientifically.

The text of Genesis 1 clearly states that God supernaturally created all that is in six actual days. If we are prepared to let the words of the text speak to us in accord with the context and their normal definitions, without influence from outside ideas, then the word for “day” in Genesis 1 obviously means an ordinary day of about 24 hours. It is qualified by a number, the phrase “evening and morning,” and for day 1, the words “light and darkness.”<sup>6</sup>

Dr. James Barr, Regius Professor of Hebrew at Oxford University, who himself does not believe Genesis is true history, admitted the following, as far as the language of Genesis 1 is concerned:

So far as I know, there is no professor of Hebrew or Old Testament at any world-class university who does not believe that the writer(s) of Gen. 1–11 intended to convey to their readers the ideas that (a) creation took place in a series of six days which were the same as the days of 24 hours we now experience, (b) the figures contained in the Genesis genealogies provided by simple addition a chronology from the beginning of the world up to later stages in the biblical story, (c) Noah’s Flood was understood to be world-wide and extinguish all human and animal life except for those in the ark.<sup>7</sup>

Besides the textual problems, progressive creationists have scientific dilemmas as well. They accept modern scientific measurements for the age of the earth, even though these measurements are based on evolutionary, atheistic assumptions. Dr. Ross often speaks of the “facts of nature” and the “facts of science” when referring to the big bang and billions of years. This demonstrates his fundamental misunderstanding of evidence. The scientific “facts” that evolutionists claim as proof of millions of years are really *interpretations* of selected observations that have been made with *antibiblical and usually atheistic, philosophical assumptions*. We all have the same facts: the same living creatures, the same DNA molecules, the same fossils, the same rock layers, the same Grand Canyon, the same moon, the same planets, the same starlight from distant stars and galaxies, etc. These are the facts; how old they are and how they formed are the *interpretations* of the facts. And what one believes about history will affect how one interprets these facts. History is littered with so-called “scientific facts” that supposedly had proven the Bible wrong, but which were shown years or decades later to be not facts but erroneously interpreted observations because of the antibiblical assumptions used.<sup>8</sup>

## The Order of Creation

### Progressive Creation

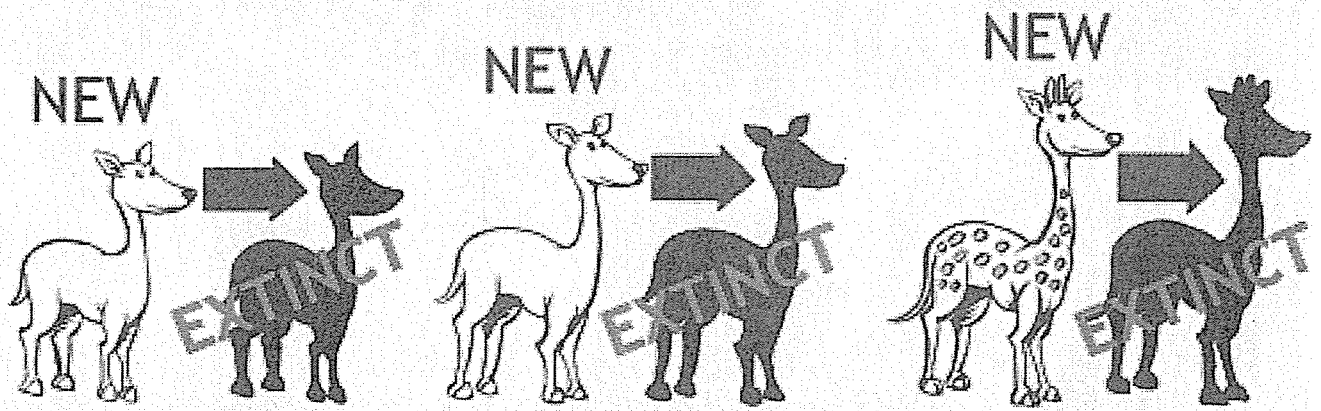

As their name indicates, progressive creationists believe that God progressively created species on earth over billions of years, with new species replacing extinct ones, starting with simple organisms and culminating in the creation of Adam and Eve. They accept the evolutionary order for the development of life on earth, even though this contradicts the order given in the Genesis account of creation.<sup>2</sup> Evolutionary theory holds that the first life forms were marine organisms, while the Bible says that God created land plants first. Reptiles are supposed to have predated birds, while Genesis says that birds came first. Evolutionists believe that land mammals came before whales, while the Bible teaches that God created whales first.

Dr. Davis Young, emeritus geology professor at Calvin College, recognized this dilemma and abandoned the “day-age” theory. Here is part of his explanation as to why he discarded it:

The biblical text, for example, has vegetation appearing on the third day and animals on the fifth day. Geology, however, had long realized that invertebrate animals were swarming in the seas long before vegetation gained a foothold on the land. . . . Worse yet, the text states that on the fourth day God made the heavenly bodies after the earth was already in existence. Here is a blatant confrontation with science. Astronomy insists that the sun is older than the earth.<sup>10</sup>

## The Sixty-seventh Book of the Bible

Dr. Ross has stated that he believes nature to be “just as perfect” as the Bible. Here is the full quote:

Not everyone has been exposed to the sixty-six books of the Bible, but everyone on planet Earth has been exposed to the sixtyseventh book—the book that God has written upon the heavens for everyone to read.

And the Bible tells us it’s impossible for God to lie, so the record of nature must be just as perfect, and reliable and truthful as the sixty-six books of the Bible that is part of the Word of God. . . . And so when astronomers tell us [their attempts to measure distance in space] . . . it’s part of the truth that God has revealed to us. It actually encompasses part of the Word of God.<sup>3</sup>

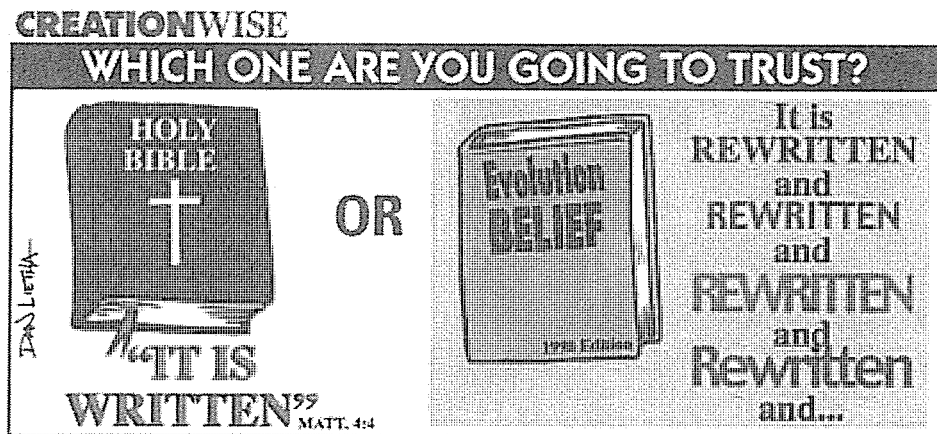

Dr. Ross is right that God cannot lie, and God tells us in [Romans 8:22](#) that “the whole creation groans and labors with birth pangs” because of sin. And not only was the universe cursed, but man himself has been affected by the Fall. So how can sinful, fallible human beings in a sin-cursed universe say that their interpretation of the evidence is as perfect as God’s written revelation? Scientific assertions must use *fallible* assumptions and *fallen* reasoning—how can this be the Word of God?

The respected systematic theologian Louis Berkhof said:

Since the entrance of sin into the world, man can gather true knowledge about God from His general revelation only if he studies it in the light of Scripture, in which the elements of God’s original self-revelation, which were obscured and perverted by the blight of sin, are republished, corrected, and interpreted. . . . Some are inclined to speak of God’s general revelation as a second source; but this is hardly correct in view of the fact that nature can come into consideration here only as interpreted in the light of Scripture.<sup>11</sup>

In other words, Christians should build their thinking on the Bible, not on fallible interpretations of scientific observations about the past.

## Death and Disease before Adam

Progressive creationists believe the fossil record was formed from the millions of animals that lived and died before Adam and Eve were created. They accept the idea that there was death, bloodshed, and disease (including cancer) before sin, which goes directly against the teaching of the Bible and dishonors the character of God.

God created a perfect world at the beginning. When He was finished, God stated that His creation was “very good.” The Bible makes it clear that man and all the animals were vegetarians before the Fall ([Genesis 1:29-30](#)). Plants were



given to them for food (plants do not have a *nephesh* [life spirit] as man and animals do and thus eating them would not constitute “death” in the biblical sense<sup>12</sup>).

Concerning the entrance of sin into the world, Dr. Ross writes, “The groaning of creation in anticipation of release from sin has lasted fifteen billion years and affected a hundred billion trillion stars.”<sup>13</sup>

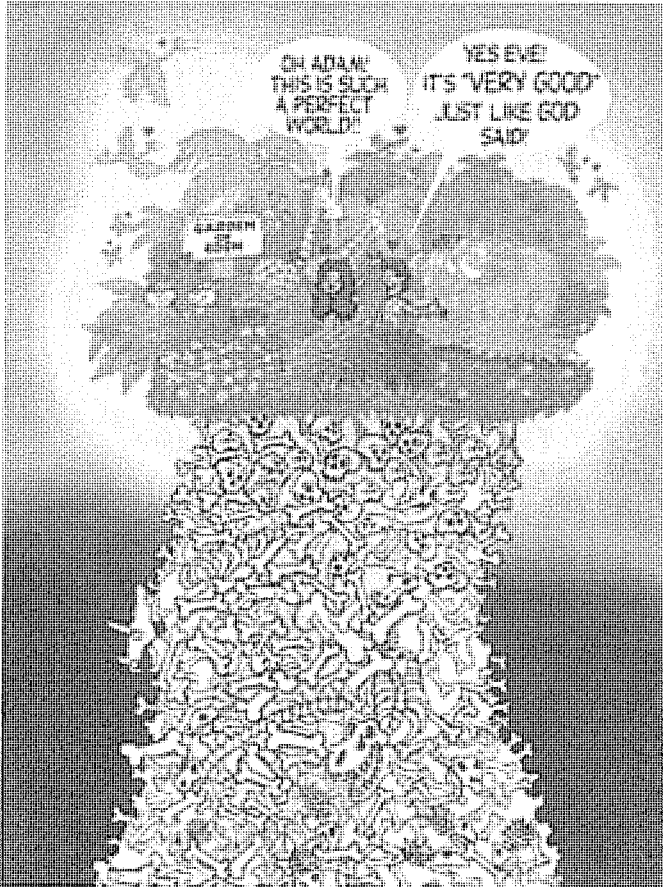

However, the Bible teaches something quite different. In the context of human death, the apostle Paul states, “Through one man sin entered the world, and death through sin” (*Romans 5:12*). It is clear that there was no sin in the world before Adam sinned, and thus no death.

God killed the first animal in the Garden and shed blood because of sin. If there were death, bloodshed, disease, and suffering before sin, then the basis for the atonement is *destroyed*. Christ suffered death because death was the penalty for sin. There will be no death or suffering in the perfect “restoration”—so why can’t we accept the same in a perfect (“very good”) creation before sin?

God must be quite incompetent and cruel to make things in the way that evolutionists imagine the universe and earth to have evolved, as most creatures that ever existed died cruel deaths. Progressive creation denigrates the wisdom and goodness of God by suggesting that this was God’s method of creation. This view attacks His truthfulness as well. If God really created over the course of billions of years, then He has misled most believers for 4,000 years into believing that He did it in six days.<sup>14</sup>

## Spiritless Hominids before Adam

Since evolutionary radiometric dating methods have dated certain humanlike fossils as older than Ross’s date for modern humans (approx. 40,000 years), he and other progressive creationists insist that these are fossils of pre-Adamic creatures that had no spirit, and thus no salvation.

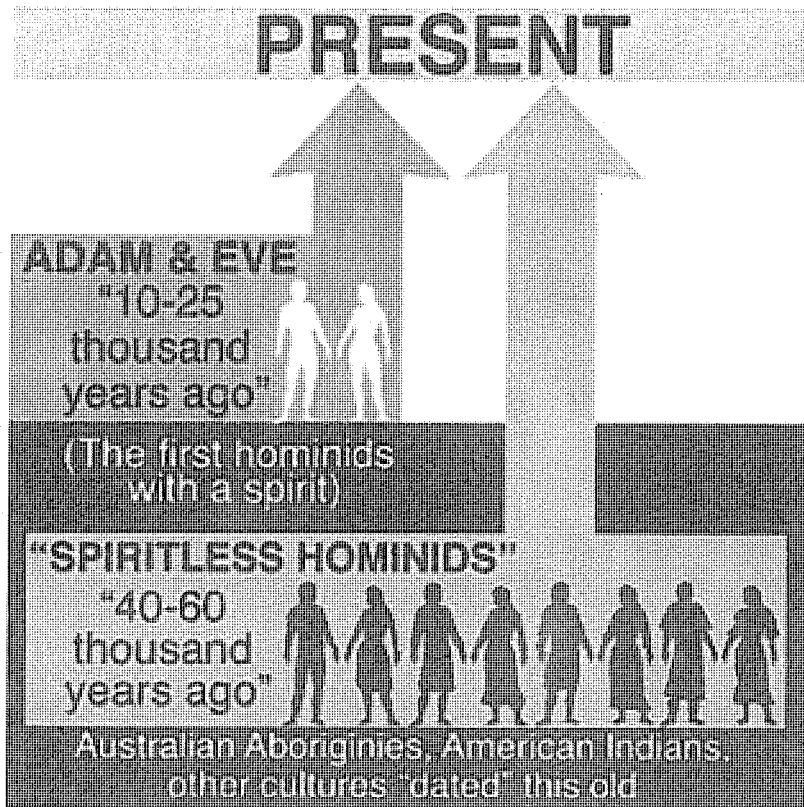

Dr. Ross accepts and defends these evolutionary dating methods, so he must redefine all evidence of humans (descendants of Noah) if they are given evolutionary dates of more than about 40,000 years (e.g., the Neandertal cave sites) as related to spiritless "hominids," which the Bible does not mention. However, these same methods have been used to "date" the Australian Aborigines back at least 60,000 years (some have claimed much older) and fossils of "anatomically modern humans" to over 100,000 years.<sup>15</sup> By Ross's reasoning, none of these (including the Australian Aborigines) could be descendants of Adam and Eve. However, *Acts 17:26* says, "And He has made from one blood every nation of men to dwell on all the face of the earth, and has determined their preappointed times and the boundaries of their dwellings" (NKJV). All people on earth are descendants of Adam.

In addition, the fossil record cannot, by its very nature, conclusively reveal if a creature had a spirit or not, since spirits are not fossilized. But there is clear evidence that creatures, which Ross (following the evolutionists) places before Adam, had art and clever technology and that they buried their dead in a way that many of Adam's descendants have.<sup>16</sup> Therefore, we have strong reason to believe that they were fully human and actually descendants of Adam, and that they lived only a few thousand years ago.

## The Genesis Flood

One important tenet of progressive creation is that the Flood of Noah's day was a local flood, limited to the Mesopotamian region. Progressive creationists believe that the rock layers and fossils found around the world are the result of billions of years of evolutionary earth history, rather than from the biblical Flood.

Dr. Ross often says that he believes in a "universal" or "worldwide" flood, but in reality he does not believe that the Flood covered the whole earth. He argues that the text of Genesis 7 doesn't really say that the Flood covered the whole earth. But read it for yourself:

19 They [the flood waters] rose greatly on the earth, and *all* the high mountains under the *entire* heavens were covered.

21 *Every* living thing that moved on the earth perished — birds, livestock, wild animals, *all* the creatures that swarm over the earth, and *all* mankind.

22 *Everything* on dry land that had the breath of life in its nostrils died.

23 *Every* living thing on the face of the earth was wiped out; men and animals and the creatures that move along the ground and the birds of the air were wiped from the earth. *Only* Noah was left, and those with him in the ark [emphasis added].

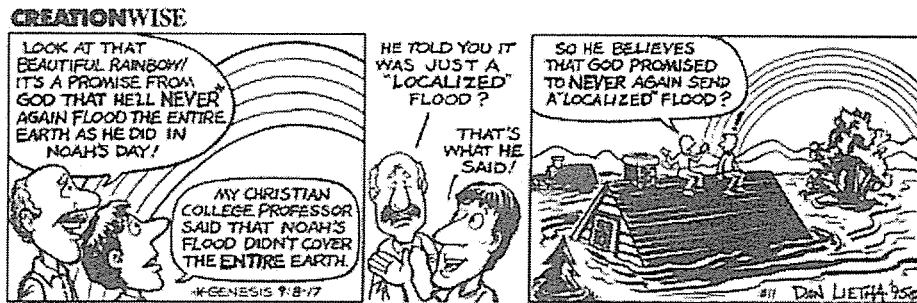

Also, many questions remain for those who teach that the Genesis flood was only local:

- If the Flood was local, why did Noah have to build an ark? He could have walked to the other side of the mountains and missed it.
- If the Flood was local, why did God send the animals to the ark so they could escape death? There would have been other animals to reproduce that kind if these particular ones had died.
- If the Flood was local, why was the ark big enough to hold all the different kinds of vertebrate land animals? If only Mesopotamian animals were aboard, the ark could have been much smaller.<sup>17</sup>
- If the Flood was local, why would birds have been sent on board? These could simply have winged across to a nearby mountain range.
- If the Flood was local, how could the waters rise to 15 cubits (8 meters) above the mountains (*Genesis 7:20*)? Water seeks its own level. It couldn't rise to cover the local mountains while leaving the rest of the world untouched.
- If the Flood was local, people who did not happen to be living in the vicinity would not be affected by it. They would have escaped God's judgment on sin. If this had happened, what did Christ mean when He likened the coming judgment of all men to the judgment of "all" men in the days of Noah (*Matthew 24:37-39*)? A partial judgment in Noah's day means a partial judgment to come.
- If the Flood was local, God would have repeatedly broken His promise never to send such a flood again.



## Conclusion

It is true that whether one believes in six literal days does not ultimately affect one's salvation, if one is truly born again. However, we need to stand back and look at the "big picture." In many nations, the Word of God was once widely respected and taken seriously. But once the door of compromise is unlocked and Christian leaders concede that we shouldn't take the Bible as written in Genesis, why should the world take heed of it in *any* area? Because the Church has told the world that one can use man's interpretation of the world (such as billions of years) to reinterpret the Bible, it is seen as an outdated, scientifically incorrect "holy book," not intended to be taken seriously.

As each subsequent generation has pushed this door of compromise open farther and farther, increasingly they are not accepting the morality or salvation of the Bible either. After all, if the history in Genesis is not correct as written, how can one be sure the rest can be taken as written? Jesus said, "If I have told you earthly things and you do not believe, how will you believe if I tell you heavenly things?" (*John 3:12*; NKJV).

It would not be exaggerating to claim that the majority of Christian leaders and laypeople within the church today do not believe in six literal days. Sadly, being influenced by the world has led to the Church no longer powerfully influencing the world.

The "war of the worldviews" is not ultimately one of young earth versus old earth, or billions of years versus six days, or creation versus evolution—the real battle is the authority of the Word of God versus man's fallible theories. Belief in a historical Genesis is important because progressive creation and its belief in millions of years (1) contradicts the clear teaching of Scripture, (2) assaults the character of God, (3) severely damages and distorts the Bible's teaching on death, and (4) undermines the gospel by undermining the clear teaching of Genesis, which gives the whole basis for Christ's atonement and our need for a Redeemer. So ultimately, the issue of a literal Genesis is about the authority of the Word of God versus the authority of the words of sinful men.

Why do Christians believe in the bodily resurrection of Jesus Christ? Because of the *words of Scripture* ("according to the Scriptures").

And why should Christians believe in six literal days of creation? Because of the *words of Scripture* ("In six days the Lord made . . .").

The real issue is one of authority—let us unashamedly stand upon God's Word as our sole authority!

Help keep these daily articles coming. [Support AiG](#).

## Footnotes

1. For a more complete analysis, see Jonathan Sarfati, *Refuting Compromise* (Green Forest, AR: Master Books, 2004); Tim Chaffey and Jason Lisle, *Old-Earth Creationism on Trial* (Green Forest, AR: Master Books, 2008); Mark Van Bebber and Paul S. Taylor, *Creation and Time: A Report on the Progressive Creation Book by Hugh Ross* (Gilbert, AZ: Eden Publications, 1994); <http://www.answersingenesis.org/home/area/faq/compromise.asp>. [Back](#)
2. Dallas Theological Seminary chapel service, September 13, 1996. [Back](#)
3. Toccoa Falls Christian College, Staley Lecture Series, March 1997. [Back \(1\)](#) [Back \(2\)](#)
4. For an evaluation of the big-bang model, see chapter 10, "[Does the Big Bang Fit with the Bible?](#)" [Back](#)
5. <http://www.reasons.org/creation-timeline>, September 13, 2005. [Back](#)
6. See *The New Answers Book*, [chapter 8](#) by Ken Ham, for a more detailed defense of literal days in Genesis 1 (Green Forest, AR: Master Books, 2006), p. 88–112. [Back](#)
7. Letter to David C.C. Watson, April 23, 1984. [Back](#)
8. See chapter 2, "[What's the Best 'Proof' of Creation?](#)" for more on how our presuppositions influence our interpretations. [Back](#)
9. Answers in Genesis website: "Evolution vs. Creation: The Order of Events Matters!" Dr. Terry Mortenson, April 4, 2006, <http://www.answersingenesis.org/docs2006/0404order.asp>. [Back](#)

10. D. Young, *The Harmonization of Scripture and Science*, science symposium at Wheaton College, March 23, 1990. [Back](#)
11. L. Berkhof, Introductory volume to *Systematic Theology* (Grand Rapids, MI: Wm. B. Eerdmans Publ. Co., 1946), p. 60, 96. [Back](#)
12. See *The New Answers Book*, [chapter 21](#) by Andy McIntosh and Bodie Hodge, p. 259–270, for more details. [Back](#)
13. Hugh Ross, “The Physics of Sin,” *Facts for Faith*, Issue 8, 2002, [http://www.reasons.org/resources/publications/facts-faith/2002issue08#physics\\_of\\_sin](http://www.reasons.org/resources/publications/facts-faith/2002issue08#physics_of_sin). [Back](#)
14. Dr. Terry Mortenson, “Genesis According to Evolution,” *Creation* 26(4) September 2004: 50–51. [Back](#)
15. T. White et al., “Pleistocene *Homo sapiens* from Middle Awash, Ethiopia,” *Nature* 423 (June 12, 2003): 742–747. Dr. Ross will permit up to 60,000 years, but this is extreme for this position. [Back](#)
16. Marvin Lubelow, *Bones of Contention*, revised and updated (Grand Rapids, MI: Baker Books, 2004). [Back](#)
17. See John Woodmorappe, *Noah’s Ark: A Feasibility Study* (El Cajon, CA: Institute for Creation Research, 1996). [Back](#)

## Recommended Resources

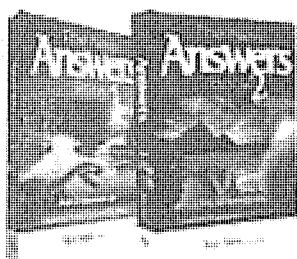

### NEW Answers Book Bundle (The)

(Retail \$29.98.) Totalling more than 55 answers to questions on creation/evolution and the Bible, these two books answer such questions as: Can natural processes explain the origin of life? Can creationists be real scientists? Where did Cain get his wife? Is evolution a religion? and more!



### NEW Answers Book 1 (The)

Packed with biblical answers to over 25 of the most important questions on creation/evolution and the Bible, *The NEW Answers Book* is a must-read for everyone who desires to better understand the world in which they live.

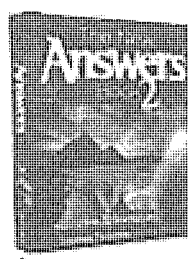

### NEW Answers Book 2 (The)

One thing is certain—skeptics don't always ask the same questions, and in today's skeptical culture, common questions are on the rise. Picking up where volume 1 left off, this second volume contains answers to more than 30 questions on creation/evolution and the Bible that can be read in any order.

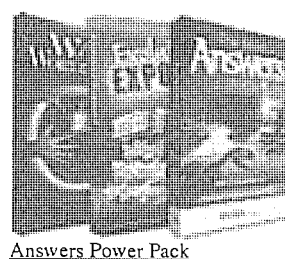

### Answers Power Pack

(Retail \$43.97.) Looking for answers about the Bible or the creation/evolution debate? Desiring to equip your children with answers for the classroom? Wanting to be equipped when unbelievers bring up hot media topics? This pack will meet all of those needs and more!

## Theistic Evolution

Despite the huge differences between creation and evolution (see previous chart), some believe in *both* creation and evolution. These *theistic evolutionists* (from Greek *theos* for “God”) teach that God created the world by an evolutionary process.<sup>9</sup> What can be said to theistic evolution claims?

1. **Inefficient:** “Evolution is the most wasteful, inefficient, cruel method that could be devised to create living things. Even evolutionists admit that almost all mutations are bad—causing cripples, sickness, disfigurements, and deaths.... God is all powerful and wise. Why would He use such a wasteful, inefficient, cruel method to create man, taking three billion years to do it, when He is able to create instantaneously?”<sup>10</sup>
2. **Unscientific:** “There is not one fact of science which proves that God used evolution to create anything.”<sup>11</sup> If God guided evolution, He has not allowed a single intermediate form of life to survive as evidence. Surely He would not allow all scientific facts to counter His creative process. All fossils represent fully formed creatures, just as one would expect from the Genesis account. But what of all the ape-like creatures that have been portrayed as transitional links between apes and man? “When all of the evidence is carefully and thoroughly studied by the best scientific methods, however, it turns out that these fossils were either from monkeys, apes, or people, and not from something that was part ape and part human.”<sup>12</sup>
  - a. *Pitldown Man*, found in Pitldown England (1912), came from jaw and skull fragments. About 500 books and pamphlets were written about him until 1950, when someone discovered that it actually was the chemically treated skull of a modern human to make it *look* old and ape teeth *filed down* to look human! This fraud fooled the world’s “experts” for almost 40 years.
  - b. *Nebraska Man* (1922) was based solely on a single tooth found in Nebraska. Additional bones of the creature later revealed it to be a pig!
  - c. *Neanderthal Man* (1860), found in the Neanderthal Valley in Germany, later had more fossils, such as a hunched-over full skeleton in France (1908). They used tools and had similar brain sizes to modern humans, but their skulls were flatter than ours and appeared primitive in some ways. However, Dr. Rudolph Virchow later revealed the hunched-over skeleton as a Frenchman who had arthritis! Other skeletons have been found which are fully erect, and x-rays of the fossil bones and teeth now confirm that all of the Neanderthals were actually humans with rickets (caused by lack of vitamin D).
  - d. Other “ape-men” are also discredited. *Ramapithecus* was an orangutan and *Orce Man* was actually a six-month-old donkey. *Australopithecus* (1924) was believed even by many evolutionists to have been an ape, and included a female version, *Australopithecus afarensis* (1973, nicknamed “Lucy”). However, when a knee joint was needed to prove that Lucy walked upright, they used one found more than 60 meters lower in the strata and more than three kilometers away!<sup>13</sup> Also, Java Man’s discoverer (Dr. Eugene Dubois) later identified him as a giant gibbon, Peking Man is an ape, and Cro-Magnon Man a modern European. Now some evolutionists even say that apes evolved from man!

---

<sup>9</sup>Modern theistic evolutionists include Francis S. Collins, *The Language of God: A Scientist Presents Evidence for Belief* (Free Press: 2006); Vernon Blackmore and Andrew Page, *Evolution: The Great Debate* (Oxford: Lion, 1989); R. J. Berry, *God and Evolution: Creation, Evolution and the Bible* (London: Hodder & Stoughton, 1988; idem, *Adam and the Ape: A Christian Approach to the Theory of Evolution* (London: Falcon, 1975). John Morton, *Redeeming Creation* (Auckland: Zealandia, 1984), 11 even calls evolution the Christian’s “cornerstone”!

<sup>10</sup>Duane T. Gish, *The Amazing Story of Creation* (El Cajon, CA: Institute for Creation Research, 1990), 44. This excellent, illustrated, 112 page full-colour book critiques evolution in simple language (SBC library # 213 GIS). See also his earlier books, *Dinosaurs: Those Terrible Lizards* and *Evolution: The Challenge of the Fossil Record*

<sup>11</sup>Gish, 44.

<sup>12</sup>Gish, 78-79. The following examples are summarized from pages 78-83.

<sup>13</sup>Dr. Solly Zuckerman (head of the Department of Anatomy, Univ. of Birmingham, England) and Dr. Charles Oxnard (Prof. of Anatomy and Director of Graduate Studies at the Univ. of Southern California Medical School) both confirm that *Australopithecus* did *not* walk upright like humans and were not man’s ancestors. Zuckerman’s conclusions are published in his book, *Beyond the Ivory Tower* (1970). See Gish, 84.

3. Theological Problems: Theistic evolution is incompatible with scriptural theology in many ways:<sup>14</sup>

- a. *The Creation Account*: The Bible gives no hint of evolution. The most natural reading of the Genesis account of creation is that God created in six literal days. The “day-age” theory where each “day” is a long period of time (even millions of years) has marshaled many advocates. However, Genesis 1 clearly says there was “evening and morning” each day. This excludes any evolutionary processes.
- b. *The Fall and the Origin of Moral Evil*: Theistic evolutionists deny that Genesis 1–11 records real history, but call these chapters “great myths,” even denying that man ever fell into sin in the Garden.<sup>15</sup> Yet the historicity of Adam is the basis upon which the NT compares Christ as the last Adam (Rom. 5:12-14; 1 Cor. 15:22, 45-49). Paul even related the historicity of Adam to the historicity of Christ’s resurrection (1 Cor. 15:12-23). The origin of evil cannot be credited simply to “the heart of mankind”<sup>16</sup> because it originally stemmed from Satan, an external force (Gen. 3:1-5; Eph. 6:12).
- c. *The Origin of Man*: Human life came when Adam was created from dust directly from God at a point in time (Gen. 2:7; cf. Matt. 19:4). Yet theistic evolutionists claim man received God’s image at an unknown point in time along the evolutionary chain; therefore, God’s image came after reproductive processes over millions of years of Adam and Eve’s “Neolithic progenitors.”<sup>17</sup> Genesis 1:26-27 says that God created man in the image of *God*—not in the image of apes. Others also claim that the Bible is concerned only with man’s relationship with God, not ordinary human life.<sup>18</sup> Such a dichotomy contradicts Genesis, which deals with far more than spiritual life. Berry denies that Adam and Eve were ancestors to all mankind,<sup>19</sup> yet Eve is said to be “the mother of all the living” (Gen. 3:20; cf. Acts 17:26) and all mankind sinned through one man (Rom. 5:12). Theistic evolution downplays or denies the extent to which sin marred God’s image. This image became so perverted that God chose to destroy all humans except for one righteous man and his family (Gen. 6:5-7).<sup>20</sup>
- d. *Natural Selection, Death, and Suffering*: Theistic evolution makes God the author of suffering and death.<sup>21</sup> This gives even atheists opportunity to criticize Christians for belief in such a cruel God. Berry insists that death existed before Adam so that his sin in the Garden only brought spiritual, not physical death.<sup>22</sup> However, no sin or death existed before the Fall (Gen. 2:17; Rom. 5:12-15) so that all suffering resulted from man’s sin, not God’s (Gen. 3:15-19; Rom. 8:19-22). God made everything “very good.”
- e. *Distinction Between Man and Animals*: Berry says man’s ability to obey is the only difference between man and animals.<sup>23</sup> But what about man’s ability to discern truth, communicate in speech, and his creative abilities? Theistic evolution is an error that vigorously opposes creation science and the Bible.

---

<sup>14</sup>David H. Lane (a biologist in Wellington, New Zealand) has published a two-part series entitled “A Critique of Theistic Evolution.” Part one is “Special Creation or Evolution: No Middle Ground,” *Bibliotheca Sacra* 150 (January-March 1994): 12-16. Part two is “Theological Problems with Theistic Evolution,” *Bibliotheca Sacra* 150 (April-June 1994): 155-74, which forms the basis for the comments in points “b” to “e” in this section.

<sup>15</sup>Alan I. Richardson, *Preface to Bible Study*, rev. ed. (London: SCM, 1972), 75; cf. Blackmore and Page, 171; Martin Bott, “Down to Earth,” in *Real Science, Real Faith*, ed. R. J. Berry (Eastbourne: Monarch, 1991), 28-29.

<sup>16</sup>Blackmore and Page, 171.

<sup>17</sup>Michael R. Johnson, *Genesis, Geology and Catastrophism: A Critique of Creationist Science and Biblical Literalism* (Exeter: Paternoster, 1988), 87; E. K. V. Pearce, *Who Was Adam?* (Exeter: Paternoster, 1969). Those who lived before Adam died not as a penalty for sin since they were “sinless” in that they had no fully evolved morality.

<sup>18</sup>Douglas C. Spanner, *Biblical Creation and the Theology of Evolution* (Exeter: Paternoster, 1987), 57-59.

<sup>19</sup>Berry, *God and Evolution*, 70.

<sup>20</sup>Lane, “Theological Problems with Theistic Evolution,” 171.

<sup>21</sup>Ibid, 90.

<sup>22</sup>Ibid, 70; idem, *Adam and the Ape*, 51.

<sup>23</sup>Berry, 159.



## Catholic and Evangelical Beliefs in Theistic Evolution

Dave Hunt, "The Berean Call" PO Box 7019 Bend, Oregon, 97708 USA (March 1997)

### Quotable

Lord, give me firmness without hardness, steadfastness without dogmatism, and love without weakness.

Jim Elliot

A good many are kept out of the service of Christ, deprived of the luxury of working for God, because they are trying to do some great thing. Let us be willing to do little things. And let us remember that nothing is small in which God is the source.

D.L. Moody

Do all the good you can, by all the means you can, in all the ways you can, in all the places you can, at all the times you can, to all the people you can, as long as ever you can.

John Wesley

If I were entirely honest every time I sang a hymn or gospel song, here's how some of the old favorites might come out: "I Surrender Some," "He's Quite a Bit to Me," "I Love to Talk about Telling the Story," "Take My Life and Let Me Be," "It is My Secret What God Can Do," "Where He Leads Me, I Will Consider Following," and "Just as I Pretend to Be."

Anonymous

### Q&A

**Question:** Your February article about evolution was informative. However, wasn't there too much emphasis upon Catholicism's support of evolution? What about Protestants and even evangelicals? Shouldn't you have pointed out that theistic evolution is quite popular in those circles as well?

**Answer:** Thank you for your reminder. I didn't have room in the article to cover acceptance among evangelical leaders and media, such as the fact that *Christianity Today* supported the Pope in his endorsement of evolution. An editorial declared (1/6/97, p. 18),

John Paul II was...reminding scientists that if they were to be faithful Christians there were limits beyond which their science could not take them...no theory of evolution was acceptable...that did not recognize the direct divine origin of the human soul.

The same support for theistic evolution was evidenced by a number of participants at a creation/evolution conference of

mostly professing evangelicals at Biola University in Southern California in mid-November, 1996. While all attending agreed that God was involved in the process, there was wide disagreement on the extent of that involvement, all the way from a strict biblical creationist view to the belief (theistic evolution) that God used evolution to create various species over millions of years. (*World*, Nov. 30/ Dec. 7, 1996, p. 18).

Like *Christianity Today*, *Promise Keepers'* official magazine, *New Man*, also endorses theistic evolution. Furthermore, *New Man* (July-Aug. 1996, p. 54) argues that whether or not God used evolution to bring man into existence is of little importance:

Remember, however, that the debate over how God created the world—through millions of years of evolutionary work or through a few words spoken over a few days—is not the central tenet of Christianity.

Christianity is, in fact, inextricably linked with all of the Bible. If any part contradicts any other part, then the whole of Scripture is undermined. If the Bible is wrong in its account of man's origin, why should we trust its teaching about man's redemption?

Like Christian psychology, theistic evolution is one more example of Christians desiring to be academically respected and thereby embracing a worldly wisdom which compromises and contradicts God's Word. *What New Man* doesn't understand, *The American Atheist* does:

But if death [of evolving prehumans] preceded man and was not a result of Adam's sin, then sin is fiction. If sin is fiction, then we have no need for a Savior...[E]volution destroys utterly and finally the very reason [for] Jesus' earthly life...If Jesus was not the Redeemer who died for our sins, and this is what evolution means, then Christianity is nothing. (As cited in *The Christian News*, Nov. 11, 1996, p. 15).

Adam is mentioned about 30 times in nine books of the Bible. Thus, to discredit the biblical account of Adam's creation punctures so many holes, not only in Genesis but in all of the Bible, that it can no longer be the container of a consistent theology. For example, Luke 3:23-38 traces Christ's genealogy to Adam, and Christ is even called "the last Adam" (1 Cor 15:45). Both associations would be demeaning to Christ if Adam were a prehuman creature that had evolved from lower animals.

Darwin himself said, "If it could be

demonstrated that any complex organ existed which could not possibly have been formed by numerous, successive, slight modifications, my theory would absolutely break down." (Charles Darwin, *Origin of Species* (New York University Press, 6th ed., 1988), p. 154). This is precisely what we find at the biochemical, cellular level, a level of life about which Darwin knew nothing and which Michael Behe so well documents in the book we're offering, *Darwin's Black Box*.

Had Darwin known of the incredible complexity of life on the molecular and cellular level, he probably would not have proposed his theory. Since the discovery of this "black box," evolutionists, right up to the present, have maintained a total silence on this subject, a silence that speaks volumes.

**Question:** As a conservative evangelical Christian and Southern Baptist pastor I was troubled that you wrote [Jan '97] "And only 55 percent of the delegates at the Southern Baptist Convention of Louisiana in November voted that the Bible is inerrant! Why don't the Christian activists show concern for this unbelief which eternally damns souls?" Mr. Hunt, are you trying to say that 45 percent of those Louisiana SBC delegates are on their way to hell, and is belief in the doctrine of inerrancy a precondition for salvation...? Please clarify your position in the next issue of TBC....I question the fairness and integrity of accusing a group of people of being-in-unbelief, heresy, and even apostasy by rejecting the doctrine of inerrancy.

**Question:** I'm sorry that what I wrote was misunderstood. I did not intend to convey that the Southern Baptists who deny the inerrancy of Scripture are necessarily lost. If they believe the gospel, they are saved eternally. What I did intend to convey was that a denial of inerrancy puts the gospel itself in question. If the Bible is not entirely true, then who is to decide which parts are valid and which parts are not? A denial of inerrancy could provide unbelievers with the excuse they seek for rejecting the gospel and thus damn their souls. No, I did not intend to convey that the 45 percent who rejected biblical inerrancy are "in unbelief, heresy, and even apostasy," but I do believe that a denial of inerrancy is a big step in the direction of all of these.

**Question:** Please take me off your mailing list. I suspect that a good friend of mine (——) put me on the mailing list. I have studied prophecy for over 20 years, exposing myself to a multitude of

— Dave Hunt, "The Berean Call," March 1997



# Sites of Evolutionists' "Missing Links"

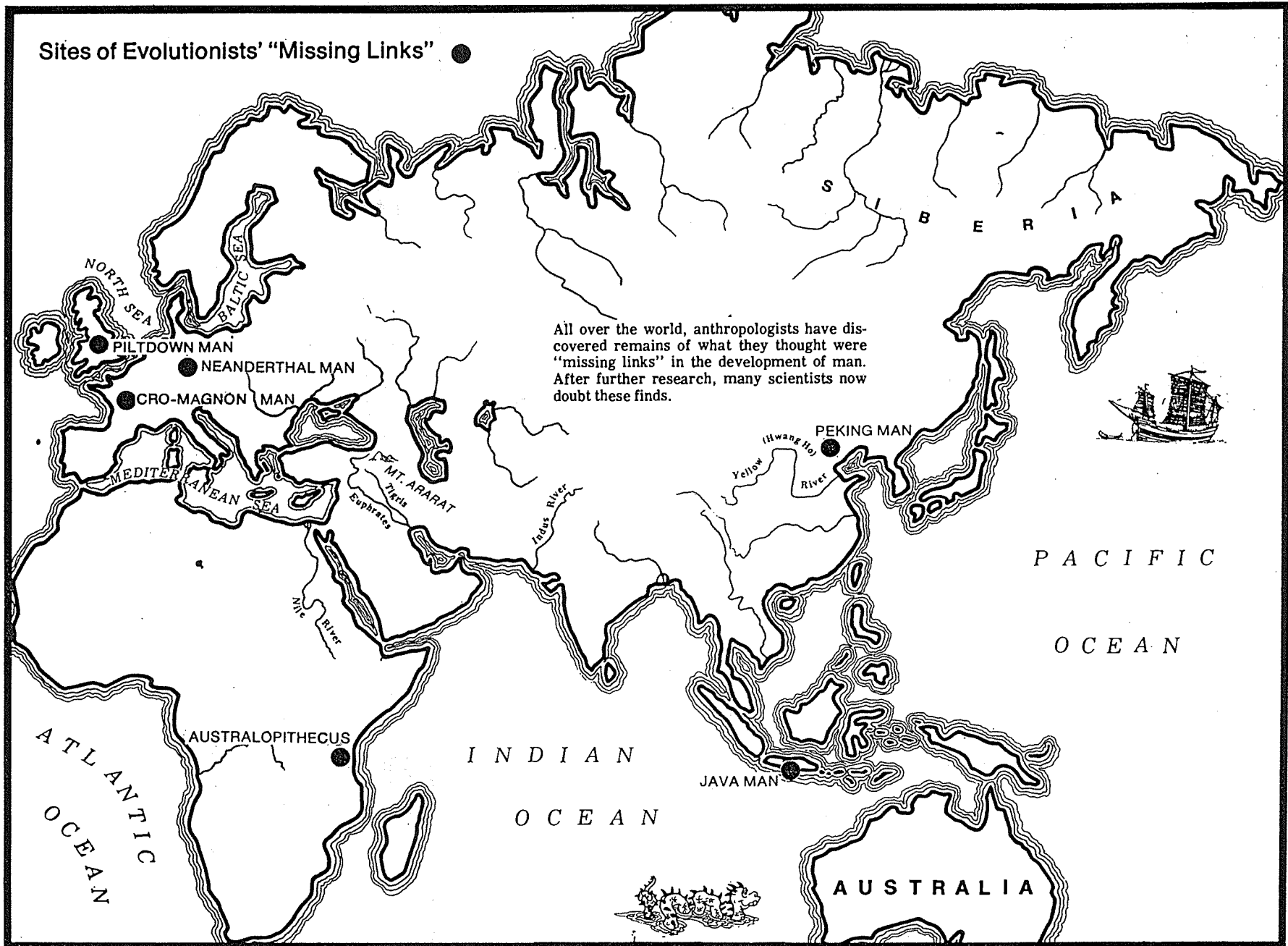

Mary Stanton + Albert Hyma, *Streams of Civilization*, 1:16  
Arlington Heights, IL: Creation-Life Pub., 1976, 1978

## Prehistoric Intelligence

Some controversial books written by non-Christian scholars argue for very intelligent civilizations in ancient times, which is consistent with the biblical record (e.g., Adam talked with God immediately and did not need centuries to know how to communicate):

Hapgood, Charles H. *Maps of the Ancient Sea Kings: Evidence of Advanced Civilization in the Ice Age*. One Adventure Place, Kempton, IL 60946: Adventures Unlimited Press, 1966. 315 pp. \$19.95 pb.

The author summarizes his thesis in the opening paragraph: "This book contains the story of the discovery of the first hand evidence that advanced sea people preceded all the people now known to history. In one field, ancient sea charts, it appears that accurate information has been passed down from people to people... [and] were passed on, perhaps by the Minoans (the Sea Kings of ancient Crete) and the Phoenicians, who were for a thousand years and more the greatest sailors of the ancient world. We have evidence that they were collected and studied in the great library of Alexandria and that compilations of them were made by the geographers who worked there... the ancient voyagers traveled from pole to pole... some ancient people explored the coasts of Antarctica when its coasts were free from ice" (p. vii). Thus the book argues that sailors knew that the earth was round thousands of years before Columbus!

Cremona, Michael A., and Thompson, Richard L. *The Hidden History of the Human Race: Major Scientific Coverups Exposed*. P.O. Box 52, Badger, CA 93603: Govardham Hill Publishing, 1994. 322 pp. \$22.95 hb.

These authors argue that millions of years ago intelligent humans lived on earth, but this evidence has been suppressed since it contradicts the evolutionary prejudices of most modern scientists. The book is dedicated to "His Divine Grace, A. C. Bhaktivedanta Swami Prabhupāda." It condenses the authors' earlier and more detailed work entitled Forbidden Archaeology (952 pp. \$39.95 hb).

# Modern man actually slept with the Neanderthal

## Ancient bones in Portugal shed new light on human evolution

NEW YORK — Neanderthal and modern humans not only coexisted for thousands of years, as anthropologists have established, but now their little secret is out: they also cohabited.

At least that is the interpretation made by paleontologists who examined the 24,500-year-old skeleton of a young boy discovered recently in a grave in Portugal.

His bones showed a genetic heritage that was part Neanderthal and part early modern Homo sapiens.

The scientists have concluded that he was a hybrid, the first strong physical evidence of interbreeding between the groups in Europe.

"This skeleton demonstrates that early modern humans and Neanderthals are not all that different," said paleoanthropologist Erik Trinkaus at Washington University in St. Louis.

"They intermixed, interbred and produced offspring."

Although some scientists have disputed the interpre-

tation, others said the findings were probably correct and certain to provoke debate and challenges to conventional thinking about the Neanderthal man's place in human evolution.

The stereotypical stocky, heavy-browed "cave man" and modern humans presumably were more alike than different, not a separate species or even subspecies, but two groups who viewed each other as appropriate mates, they said.

Recent DNA research had appeared to show the two groups were unrelated and had not interbred.

Neanderthal man lived in Europe and western Asia 300,000 years ago. The last of them disappeared on the Iberian peninsula about 28,000 years ago.

The prevailing theory is that modern humans arose in Africa less than 200,000 years ago and moved to Europe 40,000 years ago.

The new discovery could resolve the question of what happened to the Neanderthal man.

He may have merged with modern humans, who belong to the Cro-Magnon group and who appeared to have arrived in Europe with a superior tool culture.

In that case, some Neanderthal genes survive in most Europeans and people of European descent.

— NEW YORK TIMES  
ST 26 April 99

## Did Adam Speak Hebrew?

Language has always been a part of man's existence, despite the claims of the evolutionists. God and Satan both spoke with Adam and Eve in Eden itself (Gen. 2:16-17; 3:1-20). Further, the world had but one language (Gen. 11:1). But what language was this?

Some lines of evidence indicate that the original language of man was Hebrew itself:

### 1. People's names prior to Babel had Hebrew meanings.

- a) "Adam" (masculine noun) is closely related to the Hebrew *adamah* (feminine noun of "Adam," meaning "ground" BDB 9). Man being made from the dust of the earth (Gen. 2:7) is implied only in the Hebrew language, indicating that this is likely the original tongue.
- b) "Eve" means "life" in Hebrew (Gen. 3:20 הַיָּהוּה). Adam would not have given her a Hebrew name if he did not speak Hebrew.
- c) "Noah" comes from the Hebrew *nûah* ("to rest" נָח Gen. 5:29) which makes sense since his saving of mankind from the Flood brought rest to the earth. Yet this meaning is indicated in Hebrew alone.
- d) "Shem" in Hebrew also means "name" and thus indicates that the honor due to his godly line is preserved in his name itself (Gen. 5:32).
- e) "Peleg" means "division" in Hebrew since the earth was divided in his time (Gen. 10:25). The land division in Peleg's lifetime probably was the Babel dispersion (Gen. 11). This resulted in a migration to southern Arabia (Sephâr) by some Hebrews (descendants of Eber through Joktan who probably were ancestors of the Arabs; cf. p. 92). Some believe this division and migration occurred prior to the Babel judgment and preserved Hebrew as the original tongue in the area near Canaan.
- f) People called upon "the LORD" (Heb. *Yahweh*), a Hebrew name used in the earliest days of civilization (Gen. 4:26). In fact, God says that this name of his is "the name by which I am to be remembered from generation to generation" (Exod. 3:15). Some the earliest men called upon God's true name and since this is a Hebrew name, their language was most likely Hebrew.

### 2. The language of the future millennial kingdom will be Hebrew.

- a) In that day five cities in Egypt will speak the language of Canaan and swear allegiance to the LORD Almighty. One of them will be called the City of Destruction (Isa. 19:18).
- b) Since earthly conditions then will be like the original creation (Isa. 65-66), it is likely that the same language will be used as well. This would argue that the original language was Hebrew.

---

For further support of Hebrew being the original language, consult the following:

Eco, U. *The Search for the Perfect Language*. J. Fentress, trans. UK: Blackwell, 1995.

Jeffery, Grant R. *The Signature of God*. Rev. ed. Armageddonbooks.com, 2002. 345 pp. US\$13.95.

Levine. *World Literature Today* 72 (Summer 1998) available at <http://global.umi.com/pqdweb>

Saénz-Badillos, A. *A History of the Hebrew Language*. UK: Cambridge Univ., 1997.

Tenney, Merrill C. Articles in *Zondervan Pictorial Bible Dictionary*. Grand Rapids: Zondervan, pp. 526, 770, 782-83.

## Environmentalists and Evolution

Dave Hunt, "The Berean Call" PO Box 7019 Bend, Oregon, 97708 USA (October 1997)

### Dave's Itinerary

- Oct 18-20 Community Bible Fellowship  
Gig Harbor, WA  
(253) 884-1999
- Oct 28-29 Atlantic Coast Prophecy Conf 1997  
Myrtle Beach, SC  
(800) 845-2420  
(803) 755-0733
- Oct 30-Nov 1 1997 East Coast Prophecy Conf  
Willow Valley Resort & Conf Ctr  
Lancaster, PA  
(800) 652-1144
- Nov 2 Calvary Chapel of the Lehigh Valley  
Whitehall, PA  
(610) 264-7410
- Nov 7-8 ExCatholics for Christ Conf  
Grace Community Church  
Sun Valley, CA  
(972) 495-0485
- Nov 9 West Valley Bible Chapel  
Winnetka, CA  
(805) 495-4352
- Nov 14-15 Tikvah Ba Midbar  
Phoenix, AZ  
(602) 494-1243:  
(Nov 14 Desert Springs Bible Church)  
(Nov 15 Southwestern College)
- Nov 16 am Heart to Heart Bible Church  
Phoenix, AZ  
(602) 866-0889
- Nov 16 pm Calvary Southern Baptist Church  
Mesa, AZ  
(602) 986-1379

they will find another "hope" for themselves.

I am deeply angered at the many satanic beliefs promoted as "environmentalism"; these only get in the way of true understanding of what *can* realistically be done. After all, how is thanking a tree for the use of its wood any different from cutting it down without caring? Either way, the tree dies....

Mr. Hunt's paragraph on evolution cuts right to the heart of the matter. I have indeed seen writings which claim that everything our species does *is* natural—that highways, smelters, nuclear power plants, etc. are part of the natural world because they are produced by a species within the natural world. If I could say just one thing to refute an environmentalist who believes in evolution, it would be this: that if indeed evolution occurs, there is no need to save any particular species, because, given time, another would evolve to take its place anyway. Creationism, on the other hand, recognizes each species as a unique work of God, irreplaceable once it is gone. JH (WA)

## Letters

Dear TBC:

I was very happy to read "The Greening of the Cross" [July '97 TBC]. I have just recently earned a degree in environmental studies, at a school rife with just the kinds of beliefs you have criticized. As far as I know, *none* of my classmates or professors were saved, and indeed, when I attempted to witness to them they seemed not even to comprehend the message. The more I learned about the problems facing the global environment, however, the more they began to resemble some of the prophecies in Revelation; I will not state dogmatically that John was being shown pollution, global warming...but those things *could* be the methods the Lord will use. If so, how incredibly just it would be—to punish man for his rebellion through the natural results of that rebellion....

Among the unsaved in the green movement, there is only guarded optimism. Every one of them (with a few exceptions who live in bitterness and despair) believes that if we just learn more and make wiser use of our knowledge we can save the present earth. For a while, this guarded optimism was inconceivable to me until I realized that without the hope of eternal life in Christ,

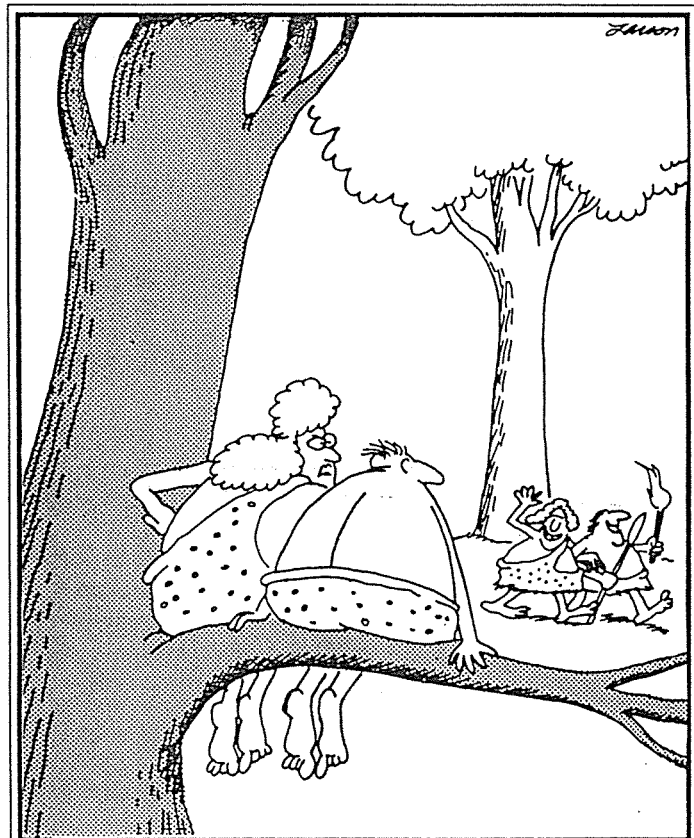

"And now there go the Wilsons! . . . Seems like everyone's evolving except us!"

The Berean Call is a nonprofit (501-[c]-3), tax-exempt corporation registered in the State of Oregon. It is overseen by an independent board which has full and final authority over all corporate assets, personnel, and affairs. (10/97)

# Ancient Near Eastern Literature Containing Parallels to the Old Testament

LITERARY WORK	LANGUAGE	DATE	OT BOOK	NATURE OF PARALLEL
Atrahasis Epic	Akkadian	~1635	Genesis	Creation, population growth, and flood with ark
Enuma Elish <sup>1</sup>	Akkadian	~1100	Genesis	Account of Creation
Gilgamesh Epic <sup>2</sup>	Sumerian Akkadian	~2000	Genesis	Account of the Flood complete with ark and birds
Memphite Theology	Egyptian	~13th c.	Genesis	Creation by spoken word
Hammurabi's Laws	Akkadian	~1750	Exodus	Laws similar to those given at Sinai in form and content
Hymn to the Aten	Egyptian	~1375	Psalms 104	Wording used in motifs and analogies; subject matter
Ludlul bel Nemeqi	Akkadian	~13th c.	Job	Sufferer questions justice of deity
Babylonian Theodicy	Akkadian	~1000	Job	Dialogue between sufferer and friend concerning the justice of deity
Instruction of Amenemope	Egyptian	~1200	Proverbs 22:17-24:22	Vocabulary, imagery, subject matter, structure
Hittite Treaties (36) <sup>3</sup>	Hittite	2nd m.	Deuteronomy Joshua 24	Format and content
Lamentations over the fall of Sumerian Cities (5)	Sumerian	20th c.	Lamentations	Phrasing, imagery, and subject matter
Egyptian Love Songs (54)	Egyptian	1300-1150	Song of Solomon	Content and literary categories employed
Mari Prophecy Texts (~50)	Akkadian	18th c.	Preclassical Prophecy <sup>4</sup>	Addressed similar subjects (military undertakings and cultic activity)

1 See chart on p. 80 Comparison of Biblical and Babylonian Creation Accounts (OTs, 73)

2 See chart on p. 81: Comparison of Biblical and Babylonian Flood Accounts (OTs, 74)

3 See chart on p. 86: Treaty Format and Biblical Covenants

## Ancient Texts Relating to the Old Testament

Major representative examples of ancient Near Eastern non-Biblical documents that provide parallels to or shed light on various OT passages.

<b>AMARNA LETTERS</b> Canaanite Akkadian 14th century B.C.	Hundreds of letters, written primarily by Canaanite scribes, illuminate social, political and religious relationships between Canaan and Egypt during the reigns of Amenhotep III and Akhenaten.
<b>AMENEMOPE'S WISDOM</b> Egyptian Early 1st millennium B.C.	Thirty chapters of wisdom instruction are similar to Pr 22:17-24:22 and provide the closest external parallels to OT wisdom literature.
<b>ATRAHASIS EPIC</b> Akkadian Early 2nd millennium B.C.	A cosmological epic depicts creation and early human history, including the flood (cf. Ge 1-9).
<b>BABYLONIAN THEOLOGY</b> Akkadian Early 1st millennium B.C.	A sufferer and his friend dialogue with each other (cf. Job).
<b>CYRUS CYLINDER</b> Akkadian 6th century B.C.	King Cyrus of Persia records the conquest of Babylon (cf. Da 5:30; 6:28) and boasts of his generous policies toward his new subjects and their gods.
<b>DEAD SEA SCROLLS</b> Hebrew, Aramaic, Greek 3rd century B.C. to 1st century A.D.	Several hundred scrolls and fragments include the oldest copies of OT books and passages.
<b>EBLA TABLES</b> Sumerian, Eblaite Mid-3rd millennium B.C.	Thousands of commercial, legal, literary and epistolary texts describe the cultural vitality and political power of a pre-patriarchal civilization in northern Syria.
<b>ELEPHANTINE PAPYRI</b> Aramaic Late 5th century B.C.	Contracts and letters document life among Jews who fled to southern Egypt after Jerusalem was destroyed in 586 B.C.
<b>ENUMA ELISH</b> Akkadian Early 2nd millennium B.C.	Marduk, the Babylonian god of cosmic order, is elevated to the supreme position in the pantheon. The 7-tablet epic contains an account of creation (cf. Ge 1-2).
<b>GEZER CALENDAR</b> Hebrew 10th century B.C.	A schoolboy from west-central Israel describes the seasons, crops and farming activity of the agricultural year.
<b>GILGAMESH EPIC</b> Akkadian Early 2nd millennium B.C.	Gilgamesh, ruler of Uruk, experiences numerous adventures, including a meeting with Utnapishtim, the only survivor of a great deluge (cf. Ge 6-9).
<b>HAMMURABI'S CODE</b> Akkadian 18th century B.C.	Together with similar law codes that preceded and followed it, the Code of Hammurabi exhibits close parallels to numerous passages in the Mosaic legislation of the OT.
<b>HYMN TO THE ATEN</b> Egyptian 14th century B.C.	The poem praises the beneficence and universality of the sun in language somewhat similar to that used in Ps 104.
<b>ISHTAR'S DESCENT</b> Akkadian 1st millennium B.C.	The goddess Ishtar temporarily descends to the netherworld, which is pictured in terms reminiscent of OT descriptions of Sheol.
<b>JEHOIACHIN'S RATION DOCKETS</b> Akkadian Early 6th century B.C.	Brief texts from the reign of Nebuchadnezzar II refer to rations allotted to Judah's exiled king Jehoiachin and his sons (cf. Ki 25:27-30).
<b>KING LISTS</b> Sumerian Late 3rd millennium B.C.	The reigns of Sumerian kings before the flood are described as lasting for thousands of years, reminding us of the longevity of the pre-flood patriarchs in Ge 5.
<b>LACHISH LETTERS</b> Hebrew Early 6th century B.C.	Inscriptions on pottery fragments vividly portray the desperate days preceding the Babylonian siege of Jerusalem in 588-586 B.C. (cf. Jer 34:7).
<b>LAMENTATION OVER THE DESTRUCTION OF UR</b> Sumerian Early 2nd millennium B.C.	The poem mourns the destruction of the city of Ur at the hands of the Elamites (cf. the OT book of Lamentations).
<b>LUDLUL BEL NEMEQUI</b> Akkadian Late 2nd millennium B.C.	A suffering Babylonian nobleman describes his distress in terms faintly reminiscent of the experiences of Job.

<b>MARI TABLES</b> Akkadian 18th century B.C.	Letters and administrative texts provide detailed information regarding customs, language and personal names that reflect the culture of the OT patriarchs.
<b>MERNEPTAH STELE</b> Egyptian 13th century B.C.	Pharaoh Merneptah figuratively describes his victory over various peoples in western Asia, including "Israel."
<b>MESHA STELE (MOABITE STONE)</b> Moabite 9th century B.C.	Mesha, king of Moab (see 2Ki 3:4), rebels against a successor of Israel's king Omri.
<b>MURASHU TABLES</b> Akkadian 5th century B.C.	Commercial documents describe financial transactions engaged in by Murashu and Sons, a Babylonian firm that did business with Jews and other exiles.
<b>MURSILIS'S TREATY WITH DUPPI-TESSUB</b> Hittite Mid-2nd millennium B.C.	King Mursilis imposes a suzerainty treaty on King Duppi-Tessub. The literary outline of this and other Hittite treaties is strikingly paralleled in OT covenants established by God with his people.
<b>NABONIDUS CHRONICLE</b> Akkadian Mid-6th century B.C.	The account describes the absence of King Nabonidus from Babylon. His son Belshazzar is therefore the regent in charge of the kingdom (cf. Da 5:29-30).
<b>NEBUCHADNEZZAR CHRONICLE</b> Akkadian Early 6th century B.C.	A chronicle from the reign of Nebuchadnezzar II includes the Babylonian account of the siege of Jerusalem in 597 B.C. (see 2Ki 24:10-17).
<b>NUZI TABLES</b> Akkadian Mid-2nd millennium B.C.	Adoption, birthright-sale and other legal documents graphically illustrate OT patriarchal customs current centuries earlier.
<b>PESSIMISTIC DIALOGUE</b> Akkadian Early 1st millennium B.C.	A master and his servant discuss the pros and cons of various activities (cf. Ecc 1-2).
<b>RAS SHAMRA TABLES</b> Ugaritic 15th century B.C.	Canaanite deities and rulers experience adventures in epics that enrich our understanding of Canaanite mythology and religion and of OT poetry.
<b>SARGON LEGEND</b> Akkadian 1st millennium B.C.	Sargon I (the Great), ruler of Akkad in the late 3rd millennium B.C. claims to have been rescued as an infant from a reed basket found floating in a river (cf. Ex 2).
<b>SARGON'S DISPLAY INSCRIPTION</b> Akkadian 8th century B.C.	Sargon II takes credit for the conquest of Samaria in 722/721 B.C. and states that he captured and exiled 27,290 Israelites.
<b>SENNACHERIB'S PRISM</b> Akkadian Early 7th century B.C.	Sennacherib vividly describes his siege of Jerusalem in 701 B.C. making Hezekiah a prisoner in his own royal city (but cf. 2Ki 19:35-37).
<b>SEVEN LEAN YEARS TRADITION</b> Egyptian 2nd century B.C.	Egypt experiences 7 years of low Niles and famine, which, by a contractual agreement between Pharaoh Djoser (28th century B.C.) and a god, will be followed by prosperity (cf. Ge 41).
<b>SHALMANESER'S BLACK OBELISK</b> Akkadian 9th century B.C.	Israel's king Jehu (or his servant) presents tribute to Assyria's king Shalmaneser III. Additional Assyrian and Babylonian texts refer to other kings of Israel and Judah.
<b>SHISHAK'S GEOGRAPHICAL LIST</b> Egyptian 10th century B.C.	Pharaoh Shishak lists the cities that he captured or made tributary during his campaign in Judah and Israel (cf. 1Ki 14:25-26).
<b>SILOAM INSCRIPTION</b> Hebrew Late 8th century B.C.	A Judahite workman describes the construction of an underground conduit to guarantee Jerusalem's water supply during Hezekiah's reign (cf. 2Ki 20:20; 2Ch 32:30).
<b>SINUHE'S STORY</b> Egyptian 20th-19th centuries B.C.	An Egyptian official of the 12th dynasty goes into voluntary exile in Syria and Canaan during the OT patriarchal period.
<b>TALE OF TWO BROTHERS</b> Egyptian 13th century B.C.	A young man rejects the amorous advances of his older brother's wife (cf. Ge 39).
<b>WENAMUN'S JOURNEY</b> Egyptian 11th century B.C.	An official of the Temple of Amun at Thebes in Egypt is sent to Byblos in Canaan to buy lumber for the ceremonial barge of his god.

## The Bible and Dinosaurs

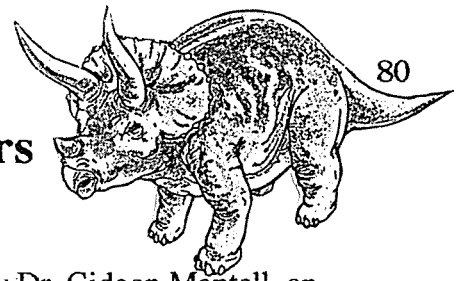

### I. What are Dinosaurs?

- A. The first dinosaur fossil, the *Iguanadon*, was found in 1822 by Dr. Gideon Mantell, an English doctor and amateur fossil hunter. After it was discovered that this find represented an entirely new type of creature, the British anatomist and paleontologist, Sir Richard Owen, named these animals “dinosaurs,” which means “terrible lizard.” Owen later became one of Charles Darwin’s strongest opponents.
- B. Generally when we think of dinosaurs we refer to extinct reptiles, most of which were quite large. Yet actually some were as small as a chicken, such as *Podokesaurus*, *Compsognathus*, and *Struthiomimus*. Many reptiles today are much larger, such as the 6 meter-long American alligator. Over 1000 Komodo dragons still live in Indonesia and are 10 feet long and over 300 pounds (3 meters and 136 kg.). These facts make a definition quite difficult to give.

### II. When Did Dinosaurs Live?

- A. Dinosaurs were either created by God or evolved by chance (see the previous handouts). Evolution postulates a date for dinosaurs which is millions of years earlier than man’s origin.
- B. However, the Bible teaches that man and dinosaurs lived at the same time. This would be quite recent if the calculation of 4143 BC for the year of creation is correct (see p. 84).
- Genesis 1:21 notes that the “great creatures of the sea” were created on the fifth day of creation, and verses 24-25 say that all the land animals were created on Day 6 of creation—the same day that Adam and Eve were created. The coexistence of man and dinosaurs is confirmed by the fossil record which indicates that all species suddenly appeared as fully formed creatures. The Paluxy river near Glen Rose, Texas even shows human and dinosaur tracks in the same strata.
  - God told Job early in the OT record, “Look at the behemoth, which I made along with you” (Job 40:15). This huge animal with strong loins lived in the water near wild animals without being afraid of them. Bible interpreters see behemoth as a hippopotamus, elephant, whale or dolphin, but none of these animals have a tail which “sways like cedar” (40:17). In fact, no known animal fits this description, indicating that the behemoth is extinct. Possibly this huge creature was *Brachiosaurus* (the largest dinosaur known, who was five stories high) or *Apatosaurus* (formerly called *Brontosaurus* until evolutionists discovered they had put the wrong head on the animal, found over a mile away!).
  - Job 41 speaks of Leviathan, another huge beast which many identify as the crocodile. This cannot be, however, due to the animal’s jaw which can’t be pierced (41:1-2), skin which can’t be traded (41:6-7), and incredible limbs (41:12). Also, Leviathan must be tall since he rises up (41:25) and looks down on other animals (41:34). Finally, he also had the ability to breathe fire (41:18-21)! While this could be taken figuratively, doing so is not required by the text as the rest of the passage speaks in literal terms. Scientists have recently discovered the bombardier beetle, which as a defense mechanism shoots very hot, irritating gases out of twin combustion tubes in its tail.<sup>16</sup> No reason exists that this could not have been duplicated on a larger scale so that a dinosaur could actually be able to shoot ignited gaseous substances from its nostrils (cf. OTS notes, 2:378-79).

### III. Were Dinosaurs on Noah’s Ark?

- A. If man and dinosaurs lived together in Job’s day (during the time of Abraham—see notes on Job), then they must have lived through the Flood which preceded Job’s time. But how could dinosaurs fit on Noah’s Ark? Where would Noah put a 30-meter high, 80-ton *Brachiosaurus*? And how could the Ark fit the millions of species of animals?

<sup>15</sup>Berry, 159.

<sup>16</sup>Gish, 96.

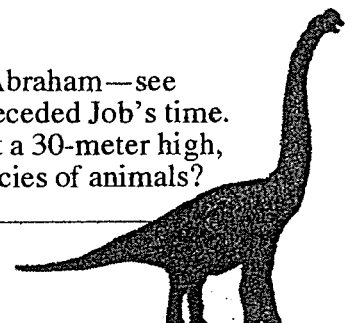

First, full-size, adult animals were not necessary to continue the species. Baby dinosaurs would have been able to reproduce just as well after they grew up.

B. Second, the Ark housed only *land-dwelling, air-breathing* animals, so it had plenty of room:

Today there are about 20,000 species of land-dwelling, air-breathing creatures in existence (i.e., mammals, birds, reptiles, amphibians). If we assume that another 20,000 species have become extinct, then 40,000 species, or approximately 80,000 animals had to fit on the Ark [i.e., two of each kind].

Some of these animals are big, but many of them, like rats, mice, lizards, and birds, are quite small. The average size of all these animals would be approximately equivalent to the size of sheep. The Ark was about 450 feet long [137 meters], 45 feet high [14 meters], and 75 feet wide [23 meters]. That means that, with its three decks, the Ark had slightly more than 100,000 square feet [9290 sq. meters] of floor space. These 80,000 animals could be caged in an area of approximately 50,000 square feet [4645 sq. meters], leaving half of the Ark's space for storage of food, air space, living space for Noah and his family, etc. Furthermore, it is possible God caused most of the animals to hibernate, in order to minimize the problems involved in their care.<sup>17</sup>

C. The Ark was so huge it could hold the equivalent of 522 modern railroad boxcars inside. All of the air-breathing creatures in existence today would take up only 150 boxcars, leaving plenty of space for food. Few of the animals would have been dinosaurs anyway; it is estimated that there may have been less than 50 kinds of dinosaurs in existence.<sup>18</sup>

D. It may seem strange that Noah would have dinosaurs on the Ark, but he would not have thought so. Noah would not have known which animals would eventually become extinct.

#### IV. How Did Dinosaurs Die Out?<sup>19</sup>

A. Several evolutionists have posed theories about how the dinosaurs became extinct:

1. Some evolutionists say that a peculiar disease wiped them out. However, creationists note that if tough dinosaurs died out, then thin-skinned mammals also would have died.
2. Others claim that an asteroid hit the earth, causing dust so thick in the air that it blocked the sun which caused the plants to die. This killed the plant-eating dinosaurs, leading to the extinction of the meat-eaters as well. However, why would an asteroid collision kill only dinosaurs and not other animals such as alligators, turtles, snakes and other reptiles?

B. The creationist climate change theory is more likely:

1. The Flood came from 40 days and 40 nights of rain (Gen. 7:12). This couldn't occur now as all the clouds in the world provide only enough rain for 1-2 inches—so much more water must have existed in the atmosphere then. This “double canopy” (atmosphere plus a water canopy) would have held in more heat from the sun than does our atmosphere today. This created a “greenhouse effect” on the earth with a worldwide mild, warm climate and lush vegetation even at the North and South Poles.
2. The Flood released enough water to cover the earth, but only a fraction of it was able to evaporate and return to the atmosphere. This caused a drastic change in climate, producing the ice-cold Arctic and Antarctic zones, temperate zones, and tropical zones which includes Singapore. Many forests were replaced with deserts as well. Thus when dinosaurs and other animals emerged from the Ark they faced a greatly reduced food supply. This would not have affected small animals as much as the large plant-eaters,

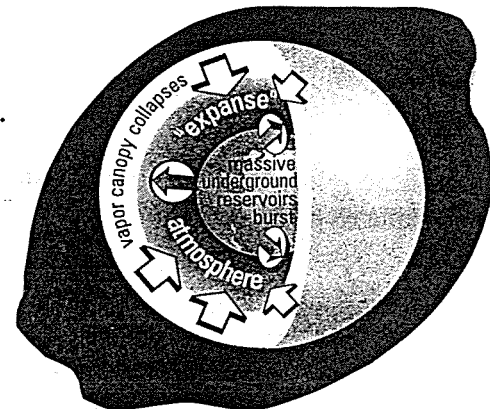

<sup>17</sup>Gish, 75.

<sup>18</sup>John Morris and Ken Ham, *What Really Happened to the Dinosaurs?* (2nd ed., El Cajon, CA: Master Books, CLP Inc., 1990), 22.

<sup>19</sup>The information in this section is taken from Gish, 73.



such as *Apatosaurus*, which ate a ton of food daily.<sup>20</sup> This limited food supply could have caused the deaths of the plant-eating dinosaurs and the deaths of those who ate them.

3. Can the double canopy theory be supported by the Bible? Yes.
  - a. The creation account mentions two collections of water separated by an expanse called “sky” (Gen. 1:6-8). This sounds as if the density of the oceans is equated with the density of the collection of water above the sky.
  - b. The Flood account notes that “the floodgates of the heavens were opened” so that rain could fall 40 days and 40 nights (Gen. 7:11-12). This more accurately depicts a canopy of water than it does a simple cloud cover.
  - c. The Bible records incredible longevity for the nine generations who lived before the Flood, ranging from 777 to 969 years (averaging 912 years).<sup>21</sup> However, after the Flood, men died at earlier and earlier ages, beginning at 600 years old and within eight generations at 205 years (averaging 333 years).<sup>22</sup> What caused man’s life span to be cut nearly two-thirds? Perhaps the best answer is the release of a water canopy around the earth at the Flood, which then allowed more ultraviolet rays from the sun to cause aging more quickly.
  - d. The dragon imagery of Revelation 12:3, 4, 7, 9, 13, 16, 17; 13:1, 2, 4, 11; 16:13; 20:2 finds parallels in writings throughout history in many independent civilizations. These stories may indicate that some dinosaurs outlived the majority who died out, perhaps because these long-lived dinosaurs lived in tropical-like areas such as caves.
4. Science also supports a worldwide Flood and worldwide tropical climate. Fossils of palm trees and ferns are found on Greenland, indicating that although it is now covered all year with ice and snow, it once had a tropical climate. The fossil graveyard of duck-billed dinosaurs found on the north shore of Alaska indicates the same. Other fossils of tropical animals exist above the Arctic Circle.
5. Other causes of dinosaur extinction have been offered by creationists.<sup>23</sup> Perhaps dinosaurs could have fought against each other and killed themselves off. Some believe an Ice Age may have followed the Flood, making the air too cold for many animals. Also, a different air composition after the Flood (including volcanic dust) possibly couldn’t sustain dinosaurs, or dinosaur eggs were eaten, or similar reasons for the extinction of other animals may explain how dinosaurs died out. Even human hunters could have killed many dinosaurs, which gave rise to the dragon stories mentioned above. No one really knows the exact reason they died out, but no evidence refutes the biblical picture of dinosaurs and humans coexisting.

## V. Concluding Summary

The Bible does not use the term “dinosaurs” since the word was not coined until the nineteenth century. However, since evolution and theistic evolution are incompatible with Scripture (see the preceding studies in these notes), dinosaurs must have been created on the fifth and sixth days of creation. Job 40–41 also likely refers to dinosaurs coexisting with man. Baby dinosaurs were taken on Noah’s Ark along with the multitudes of other animals, yet different post-Flood climate conditions led to the extinction of dinosaurs—possibly through a decreased food supply or through the collapsing of a double canopy around the earth.

---

<sup>20</sup>Morris and Ham, 28.

<sup>21</sup>Genesis 5 notes that these death ages were, in order, 930 (Adam), 912 (Seth), 905 (Enosh), 910 (Kenan), 895 (Mahalel), 962 (Jared), 365 (Enoch, but he didn’t die so his age is not averaged in), 969 (Methusaleh), 777 (Lamech), and 950 (Noah, 9:29). No pattern of decreasing or increasing age spans through the generations is observable prior to the Flood.

<sup>22</sup>Notice how the death ages generally decrease each generation after the Flood in Genesis 11: 600 (Shem), 438 (Arphaxad), 433 (Shelah), 464 (Eber), 239 (Peleg), 239 (Reu), 230 (Serug), 148 (Nahor), and 205 (Terah).

<sup>23</sup>This paragraph summarizes Morris and Ham, 28-29.

## Identity of the “Sons of God” (Gen. 6:1-2)

John H. Walton, *Chronological and Background Charts of the OT*, 2d ed., 98

	MATERIAL DISTINCTION	THEOLOGICAL DISTINCTION	SOCIAL DISTINCTION	NO DISTINCTION
SONS OF GOD	Fallen angels	Godly line of Seth	Dynastic rulers	Royal heroes of old
DAUGHTERS OF MEN	Mortals	Line of Cain	Commoners	Any woman
OFFENSE	Marriage between supernatural and mortal	Marriage of holy to unholy	Polygamy	Right of the first night: king, acting in place of deity, could spend first night with any woman getting married (fertility rite)
EVIDENCE	<ol style="list-style-type: none"> <li>1. The term “sons of God” refers only to angels. (Job 1; 38:7; Ps. 29:1; 89:7)</li> <li>2. Jude 6-7 perhaps refers to this incident. (See also 2 Peter 2:4)</li> <li>3. It is the clear reading of the text</li> <li>4. The Septuagint in Job 1 reads “angels of God”</li> <li>5. Christ says angels do not marry; doesn’t say “cannot”</li> </ol>	<ol style="list-style-type: none"> <li>1. The concept of a holy line is seemingly established (Gen. 4:26)</li> <li>2. Hebrew indicates continuity from the previous chapter</li> <li>3. The sin here becomes a common theme throughout the Pentateuch</li> </ol>	<ol style="list-style-type: none"> <li>1. Magistrates or rulers often referred to as gods (Exod. 21:6; 22:8, 9, 28; Ps. 82:1, 6)</li> <li>2. Kings sometimes called sons of deities (2 Sam. 7:14)</li> </ol>	<ol style="list-style-type: none"> <li>1. Ancient kings were regularly portrayed as sons of God</li> <li>2. Practice attested in Gilgamesh Epic (Ps. 4:32-4) as offensive</li> <li>3. Matches language of text: took wives, whichever they chose</li> </ol>
PROBLEMS	<ol style="list-style-type: none"> <li>1. Lends mythological tone</li> <li>2. Angels were not previously mentioned</li> <li>3. Why is man punished by the Flood for the wickedness of angels?</li> <li>4. New Testament support is questionable</li> </ol>	<ol style="list-style-type: none"> <li>1. The term “sons of God” never means this elsewhere</li> <li>2. No evidence that the lines are kept totally separate. The theory does not account for Adam and Eve’s other children</li> <li>3. God has not yet begun working through one line. (No concept of election)</li> <li>4. The term for men is general. It would need further classification to be understood otherwise</li> <li>5. In Noah’s time he alone was holy</li> </ol>	<ol style="list-style-type: none"> <li>1. Kingship is not expressed in any way</li> <li>2. Scripture never speaks of kings in a group as sons of deity</li> <li>3. Needs the connection of v. 4, but the “mighty men” are the Nephilim, not the children of the union</li> </ol>	<ol style="list-style-type: none"> <li>1. Scripture never speaks of kings in a group as sons of deity</li> <li>2. “Right of the first night” is not widely attested in Ancient Near East</li> </ol>

For a full discussion see *The Genesis Debate*, ed. Ronald Youngblood (Grand Rapids: Baker, 1990), 184-209.

## Biblical vs. Babylonian Flood Accounts

John H. Walton, *Chronological and Background Charts of the OT*, 2d ed., 81; cf. these notes, 83b

ITEM	GENESIS ACCOUNT	GILGAMESH EPIC
Flood divinely planned	Planned by God	Planned at council of gods Anu, Enlil, Ninurta, Ennugi, Ea, Ishtar
Divine revelation of plan to hero	God wanted to spare Noah because of his righteousness	Ea warned hero, Utnapishtim, in a dream
Reason for flood	Sin of man	Noise of man disturbed the gods' rest
Punishment	Highly ethical and just	Ethically ambiguous and later regretted
Salvation of hero	Included in God's plan	Done secretly
Life saved	8 persons (family), representatives of each animal	Representatives of all living things, beasts, several families, craftsmen, and technicians
Building of boat	Flat-bottomed, rectangular, 300 x 50 x 30 cubits, 3 levels, door, window, pitch coating	Ziggurat-shaped, 120 x 120 x 120 cubits, 7 levels, 9 sections, door, window, pitch coating
Physical causes of flood	More comprehensive: land upheavals, subterranean waters, heavy rains	Rains, winds, breaking of dikes
Duration of flood	40 days, 40 nights	6 days and nights
Landing of boat	Mountains of Ararat	Mount Nisir
Sending of birds	Raven, dove (3 times)	Dove, swallow, raven
Acts of worship	Sacrifice of worship	Sacrifice for appeasement
Blessing of hero	Earthly covenant	Divinity, immortality

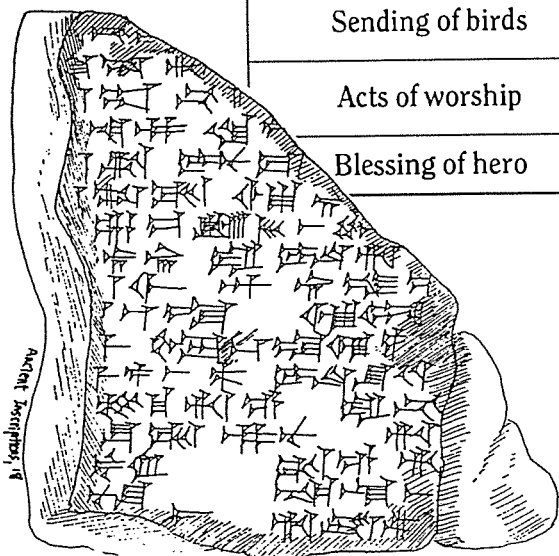

Fragment of the Gilgamesh Epic from Megiddo

## The Gilgamesh Epic

Is the Bible the only ancient record to recount a flood of huge proportions? Hardly! Over 270 civilizations have flood stories similar to the Genesis account.<sup>32</sup> In fact, if the Flood did indeed occur, it would be surprising if other civilizations did *not* have oral traditions of it. Some are even older than the Bible.<sup>33</sup> For this reason a number of scholars feel that the Bible copied from older accounts.

But is it a problem that Genesis may not contain the oldest written flood story? And would this mean that the biblical account was only copying from other sources? No—to both questions. The true story was passed on from Noah and his sons to those who descended from them. As is always true with oral tradition, the details change over time and eventually some of these stories are recorded in written form.

While some earlier written sources may have been used, as Christians we understand by faith that God revealed to Moses the true account of creation, the fall, the flood, and other events which occurred long before Moses lived (ca. 1525-1405 BC).

We should expect that other peoples would seek to record the origin of the world, and that their pagan belief system would enter into these stories. One such Babylonian example is *The Epic of Gilgamesh*. While the original epic predated Genesis, the version of this story below is probably written around 1600 BC<sup>34</sup> and includes only part of Tablet 11.

### The Great Flood



The great epic poem of Mesopotamian literature, *The Epic of Gilgamesh*, includes an account by Utnapishtim (a Mesopotamian version of the later biblical Noah), who had built a ship and survived the flood unleashed by the gods to destroy humankind. This selection recounts how the god Ea advised Utnapishtim to build a boat and how he came to land his boat at the end of the flood. In this section, Utnapishtim is narrating his tale to Gilgamesh.

#### The Epic of Gilgamesh

'In those days the world teemed, the people multiplied, the world bellowed like a wild bull, and the great god was aroused by the clamour. Enlil heard the clamour and he said to the gods in council, 'The uproar of mankind is intolerable and sleep is no longer possible by reason of the babel.' So the gods agreed to exterminate mankind. Enlil did this, but Ea [Sumerian Enki, god of the waters] because of his bath warned me in a dream. . . . 'tear down your house and build a boat, abandon possessions and look for life, despise worldly goods and save your soul alive. Tear down your house, I say, and build a boat. . . . then take up into the boat the seed of all living creatures. . . .' [Utnapishtim did as he was told and then the destruction came.]

"For six days and six nights the winds blew, torrent and tempest and flood overwhelmed the world, tempest and flood raged together like warring hosts. When the seventh day dawned the storm from the south subsided, the sea grew calm, the flood was stilled; I looked at the face of the world and there was silence, all mankind was turned to clay. The surface of the sea stretched as flat as a roof-top; I opened a hatch and the light fell on my face. Then I bowed low, I sat down and I wept, the tears streamed down my face, for on every side was the waste of water. I looked for land in vain, but fourteen leagues distant there appeared a mountain, and there the boat grounded; on the mountain of Nisir the boat held fast, she held fast and did not budge. . . . When the seventh day dawned I loosed a dove and let her go. She flew away, but finding no resting-place she returned. Then I loosed a swallow, and she flew away but finding no resting-place she returned. I loosed a raven, she saw that the waters had retreated, she ate, she flew around, she cawed, and she did not come back. Then I threw everything open to the four winds, I made a sacrifice and poured out a libation on the mountain top."

<sup>32</sup> B. Lang, "Non-Semitic Deluge Stories and the Book of Genesis: A Biblical and Critical Survey," *Anthropos* 80 (1985): 605-16.

<sup>33</sup> Gordon J. Wenham, *Genesis*, 2 vols. Word Biblical Commentary (Dallas, TX: Word, 1987, 1995), 1:159 dates a version of the Gilgamesh epic in the early second millennium. For the entire epic and his discussion, see his pages 159-66.

<sup>34</sup> Wenham, 159.

## Flood Legends

Duane T. Gish, *Dinosaurs by Design* (Master Books, 4730 Barnes Rd., Colorado Springs, CO 80917: Creation-Life Pub., 1992), 74

Evidences of a worldwide flood can be found in the more than 270 flood stories and historic records found in many parts of the world. Flood legends are common in the folk tales of many other countries. Their various interpretations reflect the way details may change when stories are told from one generation to another because of the absence of written records available to them. Let's look at just a few of these stories.

### Hawaii

Long after the death of Kuniuhonna, the first man, the world became a wicked, terrible place to live. There was one good man left; his name was Nu-u.

He made a great canoe with a house on it and filled it with animals. The waters came up over all the earth and killed all the people. Only Nu-u and his family were saved.

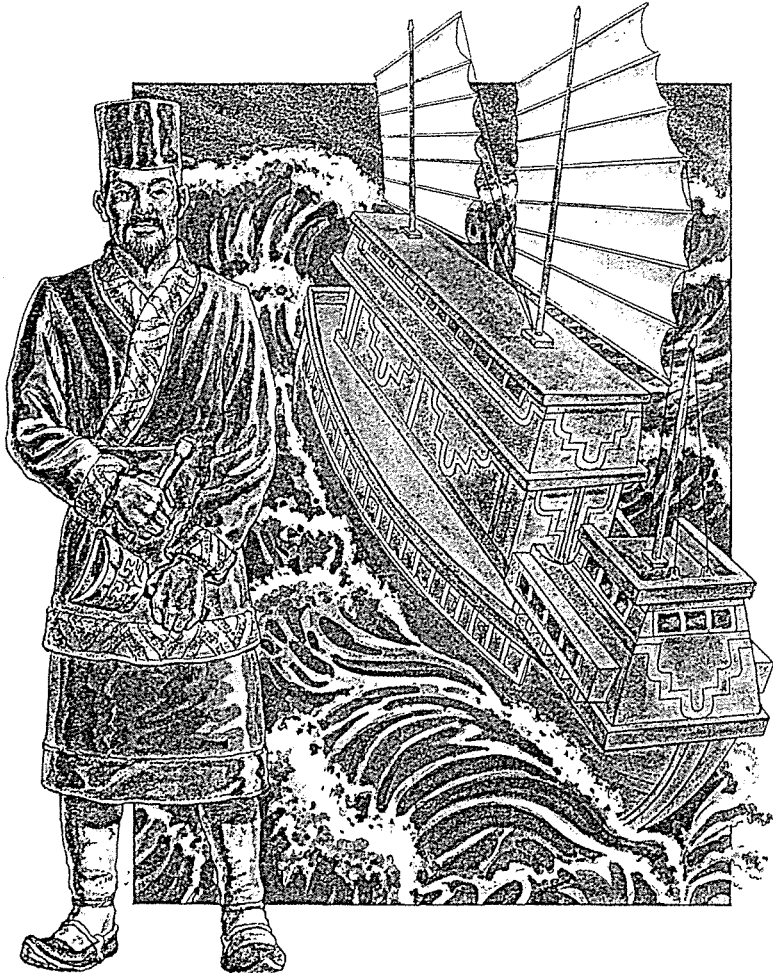

### China

Ancient Chinese writings refer to a violent catastrophe that happened to the Earth. They report that the entire land was flooded. The water went up to the highest mountains and completely covered all the foothills. It left the country in desolate condition for years after.

One ancient Chinese classic called the "Hihking" tells the story of Fuhü, whom the Chinese consider to be the father of their civilization. This history records that Fuhü, his wife, three sons, and three daughters escaped a great flood. He and his family were the only people left alive on earth. After the great flood they repopulated the world.

An ancient temple in China has a wall painting that shows Fuhü's boat in the raging waters. Dolphins are swimming around the boat and a dove with an olive branch in its beak is flying toward it.

## Flood Legends

Duane T. Gish, *Dinosaurs by Design* (Master Books, 4730 Barnes Rd., Colorado Springs, CO 80917: Creation-Life Pub., 1992), 75

### Toltec

Found in the histories of the Toltec Indians of ancient Mexico is a story of the first world that lasted 1,716 years and was destroyed by a great flood that covered even the highest mountains. Their story tells of a few men who escaped the destruction in a "toptlipetlocali," which means a closed chest. Following the great flood, these men began to multiply and built a very high "zacuali," or a great tower, to provide a safe place if the world were destroyed again. However, the languages became confused, so different language groups wandered to other parts of the world.

The Toltecs claim they started as a family of seven friends and their wives who spoke the same language. They crossed great waters, lived in caves, and wandered 104 years till they came to Hue Hue Tlapalan (southern Mexico). The story reports that this was 520 years after the great flood.

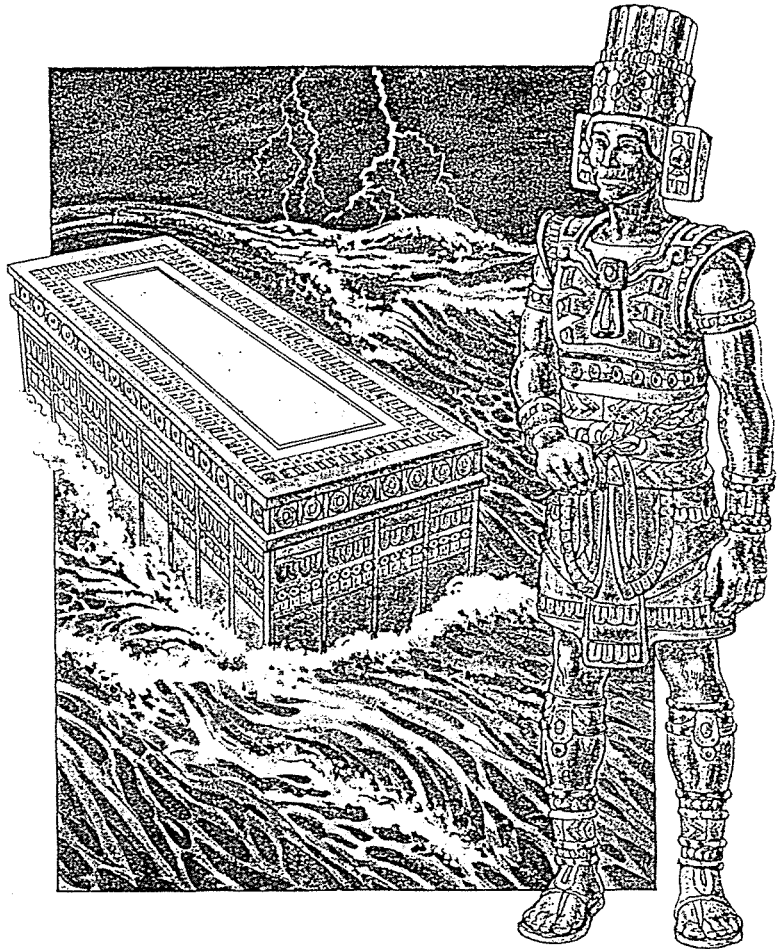

### Babylonia

Other than the record found in the Bible, the most ancient account of the Great Flood, also called the Deluge, is a tablet inscription found in Babylonia. The tablet referred to an older tablet from which this was copied, but only fragments have been found of that older copy, which was handed down from a previous king of Babylon. Because many people lived several hundred years at that time, the account of the Flood could easily have been reported by someone like King Amraphel (Genesis 14:1), who was one of the early kings of Babylonia after the Flood.

Another flood account was prevalent during the time of Alexander the Great, probably recorded by a Babylonian historian for the benefit of the Greeks. He wrote of the ante-diluvian (pre-flood) rulers and of the "great Deluge" that covered the earth.



## Time Periods of the Flood

John H. Walton, *Chronological and Background Charts of the OT*, 2d ed., 14

DATE	NUMBER OF DAYS	EVENT	GENESIS REFERENCE	
Month 2 Day 10	Waited 7	Entered the ark.	7:4, 10	
Water prevailed 150 days (7:24)	*Month 2 Day 17	Lasted 40	Rain began.	7:4-6, 11, 12
	Month 3 Day 26	End of 40	Rain stopped.	7:4, 11
	*Month 7 Day 17	End of 150	Ark rested on Ararat.	7:24; 8:4
Water receded 150 days (8:3)	*Month 10 Day 1	Waited 40	Tops of mountains visible.	8:5-6
	Month 11 Day 10	Waited 1	Raven sent.	8:7
	Month 11 Day 11	Waited 7	Dove sent; returns.	8:8-9
	Month 11 Day 19	Waited 7	Dove sent; returns with olive leaf.	8:10-11
	Month 11 Day 27		Dove sent; does not return.	8:12
	Month 12 Day 17	End of 150	Water fully receded.	8:3
Drying of earth	*Month 1 Day 1		Covering of ark removed.	8:13
	*Month 2 Day 27		Earth dry; left ark.	8:14-19
Statistics	<p style="text-align: center;">One month equals 30 days.                      Total time elapsed in the ark = 1 year, 17 days = 360 + 17 = 377 days                      7 days waiting + 150 days + 150 days + 70 days = 377 days                      water prevailing    water receding    earth drying</p>			

\*Date notation specifically mentioned in Scripture. (All others are derived.)



## Archaeology Supports Biblical Flood

"The Church Around the World" Newsletter 31 (Carol Stream, IL: Tyndale, December 2000), p. 2

### PRAYER . . .

This year 165,000 Christians will die because of their faith in Jesus Christ, estimates David Barrett, author of *Today's Martyr*. According to Barrett, 43 million Christians have been martyred since the crucifixion of Christ. Christians are the most persecuted religious community in history.

Despite a Supreme Court ruling last June that banned student-led prayer at high school football games, opening prayers led by citizens and students from within the bleachers continue: At the home opener for Reynolds High School in Asheville, N.C., most of the crowd remained standing in prayer after the national anthem was played. Many prayed the Lord's Prayer, but others prayed in various ways. After about a minute, the prayer time ended with cheers. Prayer was reported at many other school games, particularly in southern states, including Arkansas, Mississippi, North Carolina, South Carolina, and Texas.

### PRAISE . . .

#### Christian Colleges Growing

Conservative Christian colleges and universities across the country are experiencing an extraordinary increase in enrollment. The student population rose 24 percent from 1990 to 1996 at the 94 Christian schools that are members of the Council for Christian Colleges and Universities. Enrollment at secular and other religious schools is not keeping pace with the Christian schools. In the same time period, enrollment increased just 4 percent at public institutions, 5 percent at private institutions, and 11 percent at institutions with religious affiliations.

#### Survival Kits Encourage Spirituality

More than 200,000 Freshman Survival Kits (FSKs) were distributed to college freshmen this year. The kits, provided by Campus Crusade, provide attractive products and relevant messages to freshmen as they begin their college years. "We believe that it's important to communicate the gospel to every kind of student on every kind of campus," said Dan Hardaway, national coordinator for Freshman Survival Kits. "We see this as a pivotal point in a person's life." This year's FSKs will feature products designed to reach an increasingly diverse student population. "The innovations were driven by our

local ministry leaders who were talking about complex campuses—campuses where up to 86 percent of students were minorities." Some products included in the kits are three types of scripture resources, videos covering topics like alcohol and relationships, three distinctly Christian music CDs with culturally relevant music, and popular books addressing the relevance of Jesus Christ to a person's life. ✓

#### Archaeology Supports Biblical Flood

Underwater explorer Robert Ballard, famous for his discovery of the wreckage of the Titanic, has found evidence of human habitation 300 feet below the surface of the Black Sea. About 12 miles off the coast of Turkey, Ballard's team found the remains of a building composed of wooden beams, as well as stone tools, on the sea floor. Researchers estimate that the settlements are around 7,000 years old and are remarkably well preserved because of the unusually low oxygen content of the water. Ballard told the Associated Press that at some point in history the region experienced a "sudden and dramatic change from a freshwater lake to a saltwater sea." Biblical archaeologists claim that the recent discoveries on the floor of the Black Sea support the biblical account of the Noahic flood.

### THIS MONTH *You can...*

Inform your child's teacher about their religious rights in the public school. Gateways to Better Education has produced the Teacher Reacher Packet, which contains information that parents can pass along to teachers. Information cards for holidays will help teachers understand the law regarding teaching about religious aspects of holidays. The packet also includes the U.S. Department of Education's official guidelines, a parent-teacher conference checklist, a prayer request sheet, and thank-you cards to write an encouraging word to the teacher. For more information, or to order the Teacher Reacher Packet, call 1-800-A-FAMILY or order on-line at [www.family.org](http://www.family.org).

THE CHURCH AROUND THE WORLD (USPS 866-560) (ISSN 1062-2810), vol. 31, no. 1 is published monthly by Tyndale House Publishers, Inc., 351 Executive Drive, Carol Stream, IL 60188. ©2000 THE CHURCH AROUND THE WORLD. Printed in the USA. Periodicals postage paid at Carol Stream, IL 60188 and additional entry offices. Subscription \$9.00 per month per hundred copies. Canada: \$10.00 per month, payable in Canadian funds. Kenneth Taylor, publisher. James Kraus, editor. Luann Yarrow, assistant editor. POSTMASTER: Send address changes to The Church Around the World, Subscription Services, P.O. Box 464, Mt. Morris, IL 61054. Customer Service Number: 1-800-495-3265.



The Sunday Times, November 23, 1997

WORLD

# So, has the CIA finally found Noah's Ark?

By Louise Branson  
in Washington

DID the Central Intelligence Agency (CIA) find Noah's Ark? That was what several CIA officials believed after one of their spy planes flew over an icy mountain in northern Turkey near the Soviet border in 1949.

The satellite pictures taken by the plane appeared to show the outline of an ancient vessel on the side of a glacier.

It was an exciting find. But hardly one CIA chief wanted to disclose it. They were in the business of ferreting out the secrets of other countries — not religious artefacts.

They were focused on the Soviet Union — the spy planes' mission was to fly along its borders.

The last thing they wanted was to fling themselves into a religious controversy — and at the same time reveal the extent of their spying operations.

So the CIA created a secret file — The Ararat Anomaly.

It continued, clandestinely, for the next 40 years to gather information about what could be a spectacular biblical discovery.

But a single, determined pro-

## ENDURING MYSTERY THAT GOES BACK MORE THAN 5,000 YEARS

### The great flood

According to the Book of Genesis, God appeared to Noah and ordered him to make the ark. He was then supposed to take a male and a female of each species into the ark with him.

God then flooded the world for 40 days and nights.

After the flood was over, the ark came to rest on Mt Ararat.

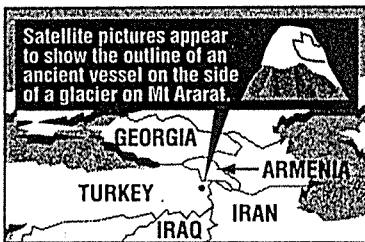

LEE CHEE CHEW

### It all adds up

The Old Testament gave precise measurements for Noah's Ark: 152 m long, 25 m wide, 15.2 m high — when the original cubits are converted.

The grainy photographs provided by the CIA showed something about that big. Scientists also knew there had been a tremendous flood in the region around 5,600 BC.

big. Scientists also knew there had been a tremendous flood in the region around 5,600 BC.

Respected theologians also reportedly supported the CIA belief, in yet more documents squirreled away in The Ararat Anomaly file.

According to the Book of Genesis, God appeared to Noah and ordered him to make the ark and take in a male and female of each species.

God then flooded the world for 40 days and nights. After the flood was over, the ark came to rest on Mount Ararat.

In the early 80s, a group of archaeologists scouring Mount Ararat, on the border of Armenia and Turkey, believed they had found the ark when they came across stones containing bolts, of the kind ancient ships dragged along as stabilisers, as well as some other debris.

But carbon-dating the material was inconclusive, and the wood had long since rotted away.

The excitement that find provoked is likely now to be rekindled.

Whether it recedes into similar disappointment remains to be seen.

fessor at the University of Richmond got wind of the file's existence and pressed for The Ararat Anomaly file to be released under the Freedom of Information Act.

Two years ago, Prof Porcher Taylor received some grainy photographs from the original 1949 flight.

Now, over the next few weeks, the spy agency is set to make public some of its hundreds of thousands of photographs, including those taken by U2 planes and which Prof Taylor

believes will show much more.

"My quest is simply scientific," the professor said. "We have to get this information into the public domain. I want secular scientists to evaluate it.

"If it's just a bunch of rocks, that's fine. But scientific evidence should be able to solve an enduring mystery that goes back more than 5,000 years."

Prof Taylor said the National Geographic Society and the Smithsonian Museum were preparing teams to help study the site, if the U2 photographs, taken

in the 70s, were more helpful.

The CIA has given the precise coordinates of the site, high up on Mt Ararat.

"Until now, people looking for the Ark never even dreamed of looking so high up," Prof Taylor said.

Even getting to the area would prove difficult. The Turkish government has closed down the area since 1991.

The mountain is surrounded by soldiers and tanks which are conducting operations against Kurdish rebels.

Those familiar with the file say the evidence gathered is persuasive. Everything seems to add up.

The Old Testament gave precise measurements for Noah's Ark: 152 m long, 25 m wide, 15.2 m high — when the original cubits are converted.

Noah's boat, according to the Bible, was "300 cubits long, 50 cubits wide and 30 cubits high".

The ancient cubit is around 20 inches or 50 cm.

The grainy photographs showed something about that

## Chronology of the Patriarchs (Gen. 5, 11)

Contrary to popular opinion, the dates on the next six pages are based upon a strict chronology in the genealogies of Genesis 5 and 11. There are several reasons for adhering to a genealogy without gaps:

1. These genealogies *state lengths of time* in contrast to other genealogies (as in Matt. 1:1-17) that are not strict genealogies but only show bloodlines. Genesis 5 and 11 give the age of each father when a son is born, which is useless data apart from a strict chronology. Also, Methuselah's death at the Flood fits perfectly.
2. The Genesis genealogies *deal with shorter lengths of time* (only from creation to Abraham) whereas later ones go from Abraham to Jesus (Matt. 1) or even Adam to Jesus (Luke 3).
3. A no-gaps sequence is the *most natural*, straightforward, objective method of interpretation.
4. The Genesis genealogies seem to *indicate a direct father-son relationship*. This is the natural usage of the term "begot" or "was the father of" (בָּרָא), especially when the Hebrew Hiphil (causative) tense is used as it is here. When a father-son relationship is *not* meant, either the Hebrew Qal tense (Gen. 36:10-12; 46:18, 25; Exod. 6:20) or the Hebrew Niphal tense is used (Deut. 23:8). Also, no one questions that Adam had a son named Seth who had Enosh (Gen. 4:25-26), or that Noah had Shem, or that Terah had Abraham.
5. Jude 14 says that Enoch was the 7th generation from Adam so there can be no gaps between these two men. Since the subsequent names have the same structure it is likely that they too lack gaps.
6. Ancient extra-biblical records support a strict chronology. The earliest European and Middle Eastern records verify the accuracy of the Table of Nations (Gen. 10-11) and the early date of creation (5200-4000 BC).<sup>35</sup>

Given this "no gap" strict chronology, exact dates can be established for many primeval events. Dates are first determined by starting at the zero year AH (Latin *anno Homo sapiens*) for "in the year of man's beginning." AH dates are then reckoned up to the substantiated date of 1845 BC and then BC dates counted backwards to creation.

<u>Event</u>	<u>Reference</u>	<u>AH</u>	<u>BC</u>
World created	"By the seventh day God had finished the work He had been doing..." (2:2a)	-6 days	4143
Adam created	"When God created man [ <i>Adam</i> ], he made him in the likeness of God" (5:1b)	0	4143
Seth born to Adam	"When Adam had lived 130 years, he had a son in his own likeness...and he named him Seth" (5:3)	130	4013
Enosh born to Seth	"When Seth had lived 105 years, he became the father of Enosh" (5:6)	235	3908
Kenan born to Enosh	"When Enosh had lived 90 years, he became the father of Kenan" (5:9)	325	3818
Mahalel born to Kenan	"When Kenan had lived 70 years, he became the father of Mahalel" (5:12)	395	3748
Jared born to Mahalel	"When Mahalel had lived 65 years, he became the father of Jared" (5:15)	460	3683
Enoch born to Jared	"When Jared had lived 162 years, he became the father of Enoch" (5:18)	622	3521

<sup>35</sup> Bill Cooper, *After the Flood* (Chichester, England: New Wine Press, 1995), 36-39, 121-29.

<u>Event</u>	<u>Reference</u>	<u>AH</u>	<u>BC</u>
Methuselah born to Enoch	"When Enoch had lived 65 years, he became the father of Methuselah" (5:21)	687	3456
Lamech born to Methuselah	"When Methuselah had lived 187 years, he became the father of Lamech" (5:25)	874	3269
Adam died	"Altogether, Adam lived 930 years..." (5:5a)	930	3213
God took Enoch away	"Altogether, Enoch lived 365 years..." (5:23-24)	987	3156
Seth died	"Altogether, Seth lived 912 years..." (5:8a)	1042	3101
Noah born to Lamech	"When Lamech had lived 182 years, he became the father of Noah" (5:28-29)	1056	3087
Enosh died	"Altogether, Enosh lived 905 years..." (5:11a)	1140	3003
Kenan died	"Altogether, Kenan lived 910 years..." (5:14a)	1235	2908
Mahalel died	"Altogether, Mahalel lived 895 years..." (5:17a)	1355	2788
Jared died	"Altogether, Jared lived 962 years..." (5:20a)	1422	2721
Shem, Ham, and Japheth all born to Noah	"After Noah was 500 years old, he became the father of Shem, Ham and Japheth" (5:32)	1558 <sup>+36</sup>	2585
Lamech died	"Altogether, Lamech lived 777 years..." (5:31a)	1651	2492
Methusaleh died	"Altogether, Methusaleh lived 969 years..." (5:27a)	1656	2487
The Flood	"Two years after the flood... Shem was 100 yrs. old" (11:10b)	1656	2487
Arphaxad born to Shem	"Two years after the flood, when Shem was 100 yrs. old, he became the father of Arphaxad" (11:10)	1658	2485
Shelah born to Arphaxad	"When Arphaxad had lived 35 years, he became the father of Shelah" (11:12)	1693	2450
Eber born to Shelah	"When Shelah had lived 30 years, he became the father of Eber" (11:14)	1723	2420
Peleg born to Eber	"When Eber had lived 34 years, he became the father of Peleg" (11:16)	1757	2386
Reu born to Peleg	"When Peleg had lived 30 years, he became the father of Reu" (11:18)	1787	2356

<sup>36</sup>The plus (+) means 5:32 says Noah's three sons were born *after* he was 500 years old but does not specify the time of Ham and Japheth's births. Since Methuselah was born in 687 AH (see 5:21 above) and lived 969 years (5:27), the 687 + 969 = 1656 AH (Scripture does not record Methuselah as having survived the Flood, so he must have died in the Flood or earlier). Since Shem was 98 years old at the Flood (Gen. 11:10), this Flood date of 1656 AH minus 98 years gives 1558 AH as the probable date of Shem's birth as the oldest son. However, it must be admitted that this chronology assumes that Shem was the oldest brother, whereas Genesis 10:21 may indicate either Shem *or* Japheth as the eldest.

<u>Event</u>	<u>Reference</u>	<u>AH</u>	<u>BC</u>
Serug born to Reu	"When Reu had lived 32 years, he became the father of Serug" (11:20)	1819	2324
Haran born to Terah	"After Terah had lived 70 years, he became the father of Abram, Nahor [II], and Haran <sup>37</sup> " (11:26)	1948	2195
Nahor II <sup>38</sup> born to Terah	"After Terah had lived 70 years, he became the father of Abram, Nahor [II], and Haran" (11:26)	1949- 2007 <sup>39</sup>	2194- 2136
Peleg died	"After he became the father of Reu, Peleg lived 209 years..." (11:17a)	1996	2147
Nahor I died	"After he became the father of Terah [1878 AH], Nahor [I] lived 119 years..." (11:25a)	1997	2146
Noah died	"Altogether, Noah lived 950 years..." (9:29)	2006	2137
Abram <sup>40</sup> born to Terah	"After Terah had lived 70 years, he became the father of Abram, Nahor [II], and Haran" (11:26)	2008	2135
Sarai born	Sarai was 10 years younger than Abram since he was 100 when she was 90 (17:1, 17)	2018	2125
Reu died	"And after he became the father of Serug, Reu lived 207 years..." (11:21a)	2026	2117
Serug died	"And after he became the father of Nahor [I], Serug lived 200 years..." (11:23a)	2049	2094
Shem died	"And after he became the father of Arphaxad, Shem lived 500 years..." (11:11a)	2058	2085
Terah died	"Terah lived 205 years, and he died in Haran" (11:32)	2083	2060
Abram left Haran	Abram went to Canaan at age 75 just after the Abrahamic Covenant was given in Haran (12:4-5)	2083	2060
Abram went to Egypt	"Now there was a famine in the land, and Abram went down to Egypt..." (12:10)	2085?	2058?
Abrahamic Covenant ratified	"Lift up your eyes... All the land you see I will give to you and your offspring forever" (13:14-15)	2089?	2054?
Ishmael born	"Abram was 86 years old when Hagar bore him Ishmael" (16:16)	2094	2049

<sup>37</sup>The text does not tell the time of the births of Abram, Nahor and Haran. However, Haran had a son (Lot) even before Abram and Nahor were married (11:27-28), so he was the oldest son and was born when Terah was 70 years old.

<sup>38</sup>Obviously, this Nahor is a different Nahor than his grandfather by the same name.

<sup>39</sup>Since Nahor was the middle son he must have been born between Haran (1948 AH) and Abram (2008 AH).

<sup>40</sup>Abram was 75 years old when he set out from Haran (2083 AH or 2060 BC; 12:4), which was immediately after Terah's death (Gen. 11:32; Acts 7:4), probably in the same year. Therefore, his birth 75 years earlier would have been 2008 AH or 2135 BC (2083 - 75 = 2008, or 2060 + 75 = 2135).

<u>Event</u>	<u>Reference</u>	<u>AH</u>	<u>BC</u>
Arphaxad died	"And after he became the father of Shelah, Arphaxad lived 403 years..." (11:13a)	2096	2047
Abrahamic Covenant reconfirmed	Abraham was circumcised at age 99 and Ishmael at age 13; "Sarah will bear [Isaac] to you by this time next year" (17:21, 24-25)	2107	2036
Destruction of Sodom	Cities of the Plain destroyed between Abraham's circumcision and Isaac's birth	2107	2036
Isaac born	"Abraham was 100 years old when his son Isaac was born to him" (21:5; cf. 17:17)	2108	2035
Isaac taken to Mt. Moriah	"Some time later... Do not lay a hand on the boy" (22:1, 12)—estimates Isaac to be 17 years old	2125?	2018?
Shelah died	"And after he became the father of Eber, Shelah lived 403 years..." (11:17a)	2126	2017
Sarah died	"Sarah was 127 years old" (23:1)	2144	1991
Isaac marries	"Isaac was 40 years old when he married Rebekah" (25:20)	2148	1995
Shem died	"After he became the father of Arphaxad, Shen lived 500 years..." (11:11) and died at 600 years (11:10)	2158	1985
Jacob and Esau born	"Isaac was 60 years old when Rebekah gave birth to them" (25:26)	2168	1975
Abraham died	"Altogether, Abraham lived 175 years" (25:7)	2183	1960
Eber died	"And after he became the father of Peleg, Eber lived 430 years..." (11:17a) for a total of 464 years	2187	1956
Esau marries	"When Esau was 40 years old, he married Judith... and also Basemath..." (26:34)	2208	1935
Ishmael died	"Altogether, Esau lived 137 years" (25:17)	2231	1912
Jacob fled to Laban	Jacob was 77 years old <sup>41</sup>	2245	1898
Jacob married both Leah and Rachel	So Jacob. . . loved Rachel more than Leah, and served Laban for another seven years (29:30)	2252	1891
Joseph born	Jacob was 91 at Joseph's birth (see footnote below)	2259	1884

<sup>41</sup> The logic for Jacob's age of 77 when he fled to Laban at Paddan Aram is such: "Joseph stood before Pharaoh, aged 30 (41:46). At the end of 7 years' of plenty Joseph was 37 (41:29-30). At the end of 2 years' famine, when Jacob came down into Egypt, Joseph was 39 (45:6). At the end of 2 years' famine, when Jacob came down into Egypt, Jacob was 130 (47:9). Therefore Jacob was 130 when Joseph was 39. Therefore Jacob was 91 when Joseph was born. Jacob had served Laban 14 years when Joseph was born (29:30; 30:25-26). Therefore Jacob was 91 - 14 = 77 when he left home for Paddan Aram" (Martin Anstey, *The Romance of Bible Chronology: An Exposition of the Meaning, and a Demonstration of the Truth, of Every Chronological Statement Contained in the Hebrew Text of the Old Testament*, 2 vols. [London, Edinburgh, and New York: Marshall Bros., 1913], 1:115); cited by Hoehner, 2).

<u>Event</u>	<u>Reference</u>	<u>AH</u>	<u>BC</u>
Jacob returned to Canaan	At age 97, Jacob returned to Canaan after 20 years and was restored with his brother Esau (31:38, 41)	2265	1878
Abrahamic Covenant confirmed to Jacob at Bethel	At age 100, God confirmed his covenant to Jacob one final time and changed his name to Israel (35:9-15); This is the beginning of the 430 years in Canaan and Egypt (Exod. 12:40). <sup>42</sup>	2268	1875
Joseph sold	"Joseph, a young man of 17, was tending his flocks..." (37:2, 28)	2276	1867
Joseph interpreted dreams of baker and cupbearer	"When 2 full years had passed, Pharaoh had a dream" (41:1); Since Joseph was 30 upon entering Pharaoh's service (41:46), his dream interpretations for the baker and cupbearer were at age 28.	2287	1856
Isaac died	"Isaac lived 180 years" (35:28); Jacob was 120 at Isaac's death since Isaac was 60 at Jacob's birth (25:26)	2288	1855
Joseph interpreted Pharaoh's dream	"Joseph was 30 years old when he entered the service of Pharaoh" (41:46)	2289	1854
Seven years of Abundance	Joseph was immediately appointed by Pharaoh to administer the food of Egypt (41:41, 46)	2289- 2296	1854- 1847
Seven years of Famine	These immediately followed the 7 years of abundance	2296- 3003	1847- 1840
Jacob and family go to Egypt	Jacob was 130 (47:9) while entering Egypt during the second year of the famine (45:6); this occurred 400 years before the Exodus in 1445 BC. <sup>43</sup> Joseph was 39.	2298	1845 <sup>44</sup>
Jacob died	Jacob died at 147 after living in Egypt 17 years (47:28), so Joseph was 56 years old.	2315	1828
Joseph died	Joseph died at 110 (50:26), so he lived another 71 years in Egypt after his family arrived there.	2369	1774

<sup>42</sup> Harold W. Hoehner, "The Duration of the Egyptian Bondage," *Bibliotheca Sacra* 126 (October-December 1969): 306-16). Note that many evangelical OT scholars believe that Jacob's family entered Egypt in 1875 BC (see these notes, 96, 108) since this is 430 years before the Exodus in 1445. In contrast, Hoehner's chronology followed here follows the LXX and Samaritan Pentateuch reading of Exodus 12:40 which cites the 430 years as applying to the time the Israelites lived in "Egypt and Canaan." This is preferred since they were not called Israelites until Jacob's name was changed to Israel in 1875. "The commencement of their sojourning would have been the last confirmation of the Abrahamic covenant as given in Genesis 35:9-15, if one notices that from Genesis 35 onwards the children of Israel never remained in one place in Canaan but were always travelling (cf. Gen 35:16,21,27; in 37:1 they dwelt in the land of Canaan with no specific location mentioned)... Therefore, it seems that if one will take the 430 years as the period from the last recorded confirmation of the Abrahamic covenant to Israel (Jacob) before going into Egypt (Gen 35:9-15) until the time of the Exodus, the 400 years would be that period of time when the nation Israel was in Egypt, that is, from the time when Jacob and his family entered Egypt (Gen 46) until the Exodus. The phrase 'about 450 years' (Acts 13:19-20) would consist of the 400 years of bondage plus the 40 years of wilderness wanderings plus the 7 years for conquering the land of Palestine which makes a total of 447 years or 'about 450 years'" (ibid., 315, 316).

<sup>43</sup> Ibid., 316.

<sup>44</sup> This 1845 BC date is actually the starting point of the BC dates on page 85. The year 1845 BC has been determined as the year Jacob entered Egypt (400 years before the early date for the Exodus in 1445 BC). The dates between Abram's birth and 1845 BC are adapted from Harold W. Hoehner, "From the Birth of Abram to the Death of Joseph" (class handout in Th.D. course "Bible Chronology," Dallas Theological Seminary, June 1988, 3 pp.).

Timeline of the Patriarchs

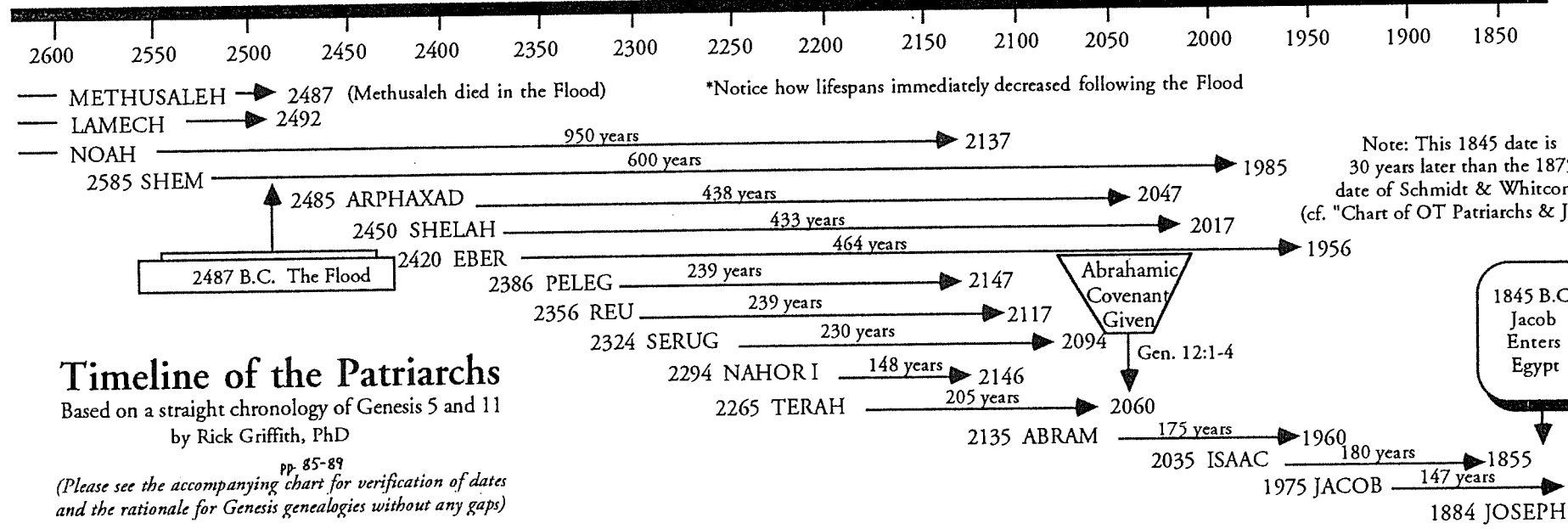
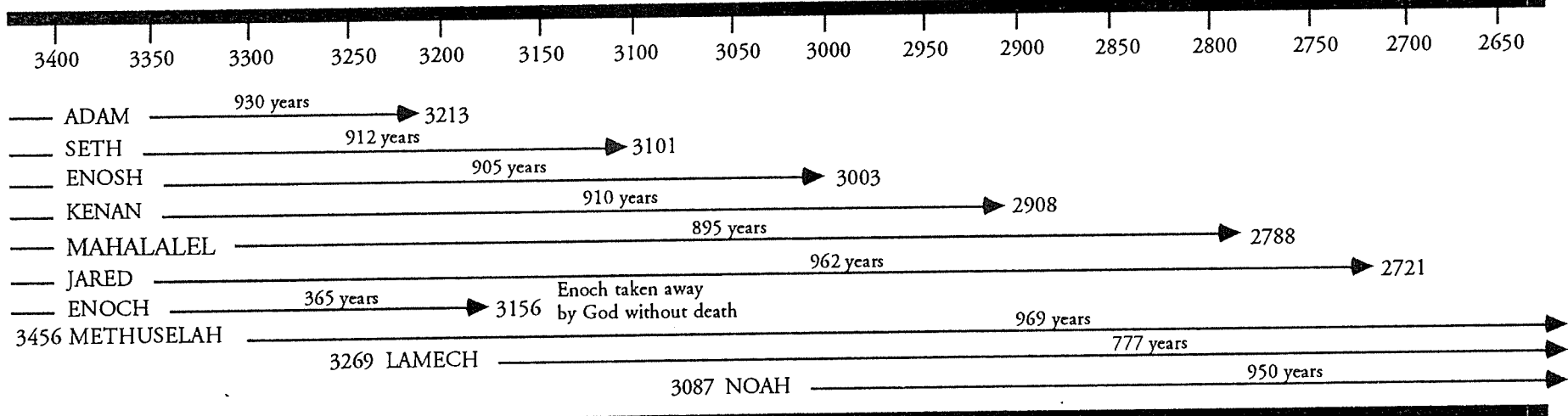
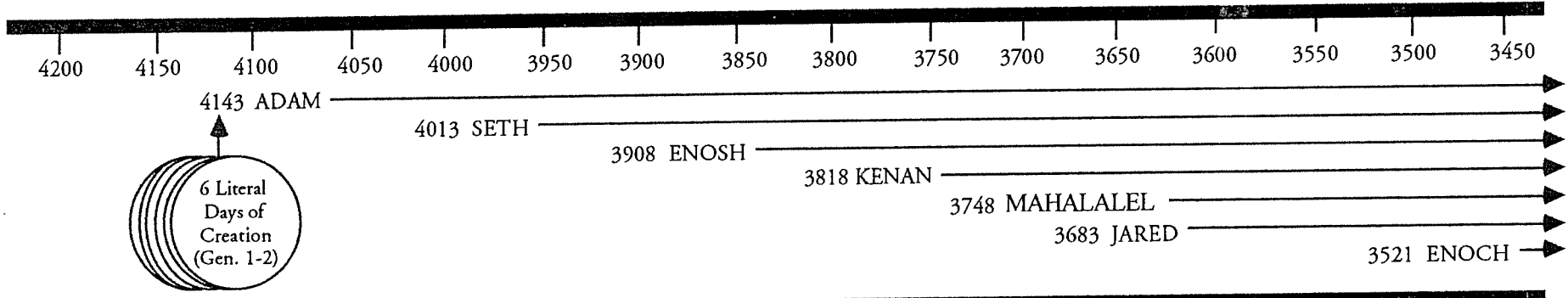

**Timeline of the Patriarchs**  
Based on a straight chronology of Genesis 5 and 11  
by Rick Griffith, PhD

pp. 85-89  
(Please see the accompanying chart for verification of dates and the rationale for Genesis genealogies without any gaps)

## Scientific Support for a Young Earth

Adapted from <http://www.answersingenesis.org/home/area/feedback/2006/0303.asp>

Dear Dr. Mortenson,

...What are the most compelling scientific evidences of a young earth?

With Joy in Jesus,

Tony

---

Tony,

...Regarding the impact of intelligent design arguments on intellectuals, this strategy of using design arguments which are divorced from Scripture was tried once before, in the early 19th century, and it failed to convert people or to overcome the growing skepticism in the once-Christian cultures of Britain and America. In fact, many of those who were arguing for design in this way were also leading the church to reject Genesis 1–11 and accept the geological theory of millions of years—50 years before Darwin published his famous book on evolution...

Scientific arguments for a young earth are numerous:

1. The old-earth idea was developed historically, not from letting the physical facts speak for themselves but by imposing anti-biblical philosophical assumptions onto the geological observations. See this [article](#) and this [DVD](#).
2. The radiometric dating methods are based on those same naturalistic, uniformitarian, anti-biblical assumptions and there is plenty of published evidence that they do not give valid dates. Besides the RATE research mentioned earlier, consider the well-researched arguments in *The Mythology of Modern Dating Methods* [by John Woodmorappe, 1999]. You cannot expect this icon of evolution to be overthrown in a few short paragraphs.
3. John Morris's book (*The Young Earth*) gives a good layman's summary (with documentation and plenty of pictures to illustrate) of some of the strongest evidences for a young-earth and global Flood. For more in-depth arguments see John Woodmorappe's book (*Studies in Flood Geology*). Excellent DVDs illustrating some of these points are on Mt. St. Helens (*Mount St. Helens: Explosive Evidence for Catastrophe*) and Grand Canyon (*The Grand Canyon: Monument to the Flood*). Creationist scientists (or any scientists, for that matter) don't have answers to everything and so are continuing to do research (and the number of qualified creationist geologists is increasing), but following is some of the evidence brought out in these resources:
  - a. The almost complete absence of evidence of erosion or soil layers or the activity of living things (plant roots, burrow marks, etc.) [is missing] at the upper surface of the various strata (showing that the stratum did not lay there for thousands or millions of years before the next layer was deposited).
  - b. Polystrate fossils (usually trees)... cut through more than one layer of rock (even different kinds of rock supposedly deposited over thousands if not millions of years). The trees would have rotted and left no fossil evidence if the deposition rate was that slow.
  - c. Soft-sediment deformation—that thousands of feet of sedimentary rocks (of various layers)—are bent (like a stack of thin pancakes over the edge of a plate), as we see at the mile-deep Kaibab Upwarp in the Grand Canyon. Clearly the whole, mile-deep deposit of various kinds of sediment was still relatively soft and probably wet (not like it is today) when the earthquake occurred that uplifted one part of the series of strata.



- d. Many fossils... show (require) very rapid burial and fossilization. For example, soft parts (jellyfish, animal feces, scales and fins of fish) or whole, large, fully-articulated skeletons (e.g., whales or large dinosaurs such as T-Rex) are preserved. Or we find many creatures' bodies contorted. All this evidence shows that these creatures were buried rapidly (in many cases even buried alive) and fossilized before scavengers, micro-decay organisms and erosional processes could erase the evidence. These are found all over the world and all through the various strata.
  - e. The rock record [screams] "Noah's Flood" and "young earth." The secular geologists can't hear or see the message because of their academic indoctrination in anti-biblical, naturalistic, uniformitarian assumptions. The reason that most Christian geologists can't see it is the same, plus the fact that they have believed the scientific establishment more than the Bible that they claim to believe is the inspired, inerrant Word of God. There are also thoroughly researched scientific refutations of skeptical objections to Noah's Ark and the Flood here, which strengthen one's faith in the biblical account of the Flood.
4. Creationists still have many challenges regarding the scientific evidence for a young universe, but distant starlight is no more of a problem for young-earth creationists than it is for big bang proponents, as this DVD by Dr. Jason Lisle (Ph.D. in astrophysics) shows: Distant Starlight.

Both God's Word and His creation are saying the same thing. And over the past 50 years, true science has been increasingly confirming Scripture. With more research by both evolutionists and creationists in the years ahead, we can fully expect that many questions that young-earth creationists cannot presently answer will later be answered and will be shown to confirm that God created the whole universe a few thousand years ago, then cursed His whole creation a few days later because of Adam's sin and then destroyed it with a global, catastrophic, year-long flood at the time of Noah, just as the Bible clearly teaches.

I hope that you will consider these resources and study Genesis 1–11 more carefully, and then submit to the authority of God's Word in all things.

God bless,

Dr. Terry Mortenson

Answers in Genesis—USA

---

Please look up this site and click on the underlined links above for further study in this vital subject:  
<http://www.answersingenesis.org/home/area/feedback/2006/0303.asp>

Q: How does carbon-14 confirm a young earth? ([http://www.answersingenesis.org/articles/am/v7/n4/carbon-14?utm\\_source=answers-weekly&utm\\_medium=email&utm\\_content=main-question&utm\\_campaign=aw11242012](http://www.answersingenesis.org/articles/am/v7/n4/carbon-14?utm_source=answers-weekly&utm_medium=email&utm_content=main-question&utm_campaign=aw11242012))

A: Carbon-14 (or radiocarbon) is a radioactive form of carbon that scientists use to date fossils. But it decays so quickly—with a half-life of only 5,730 years—that none is expected to remain in fossils after only a few hundred thousand years. Yet carbon-14 has been detected in "ancient" fossils—supposedly up to hundreds of millions of years old—ever since the earliest days of radiocarbon dating.

Even if every atom in the whole earth were carbon-14, they would decay so quickly that no carbon-14 would be left on earth after only 1 million years. Contrary to expectations, between 1984 and 1998 alone, the scientific literature reported carbon-14 in 70 samples that came from fossils, coal, oil, natural gas, and marble representing the fossil-bearing portion of the geologic record, supposedly spanning more than 500 million years. All contained radiocarbon.

## Patriarchal Family Tree

John H. Walton, *Chronological and Background Charts of the OT*, 2d ed., 16

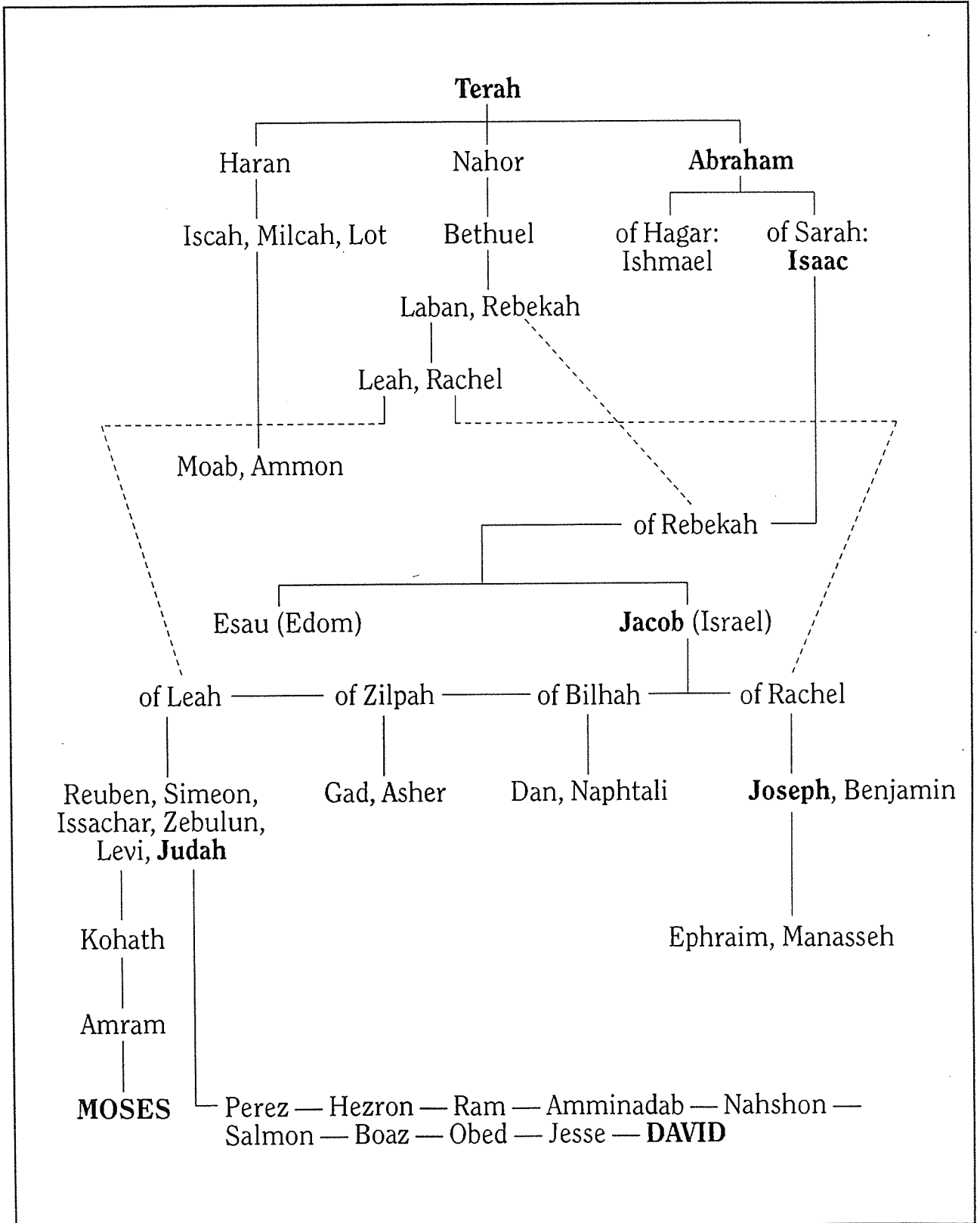

Dawn of Civilizations

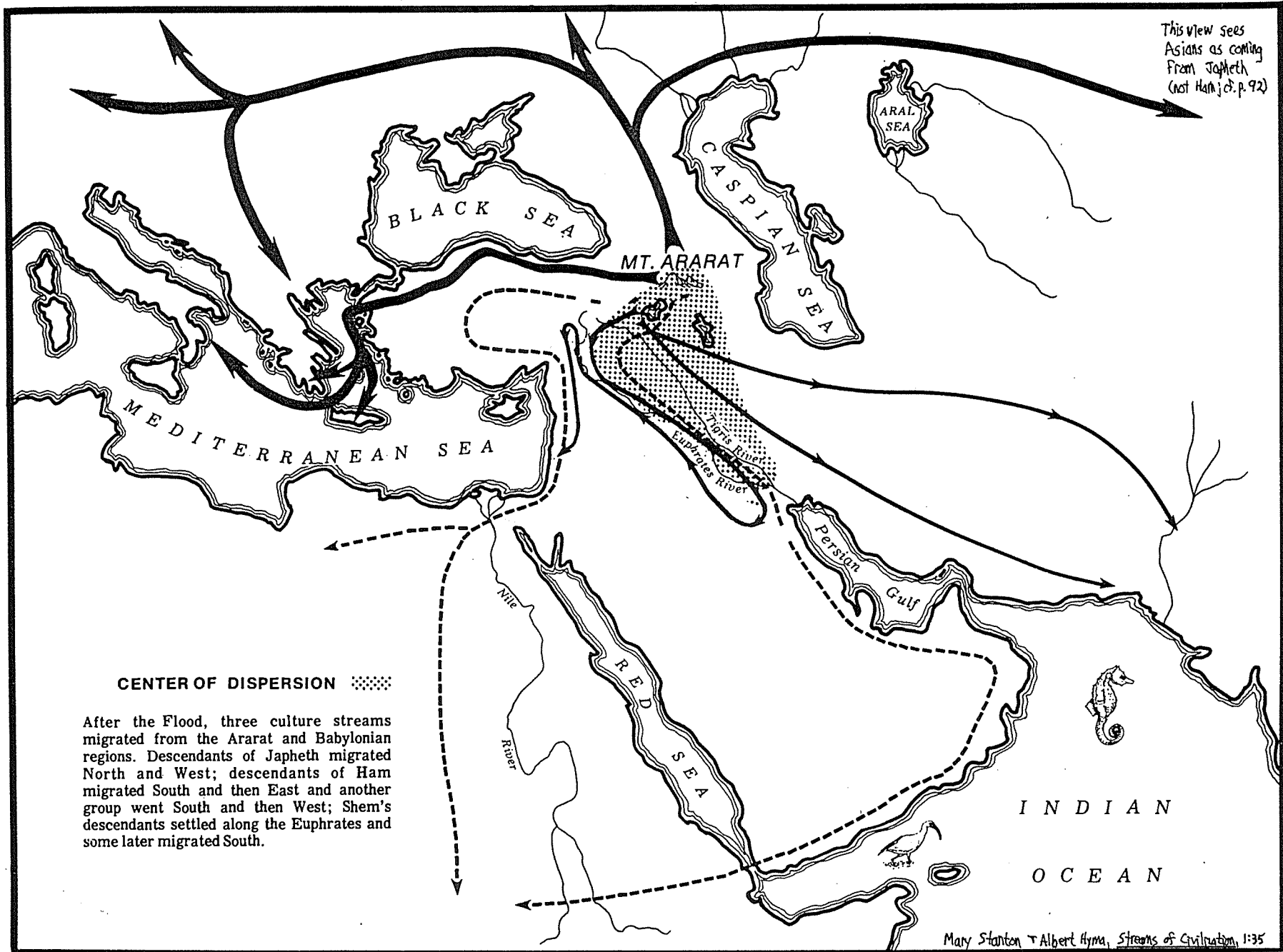

Mary Stanton & Albert Hyma, *Streams of Civilization*, 1:35  
Arlington Heights, IL: Creation-Life Pub., 1976, 1978

# Table of Nations

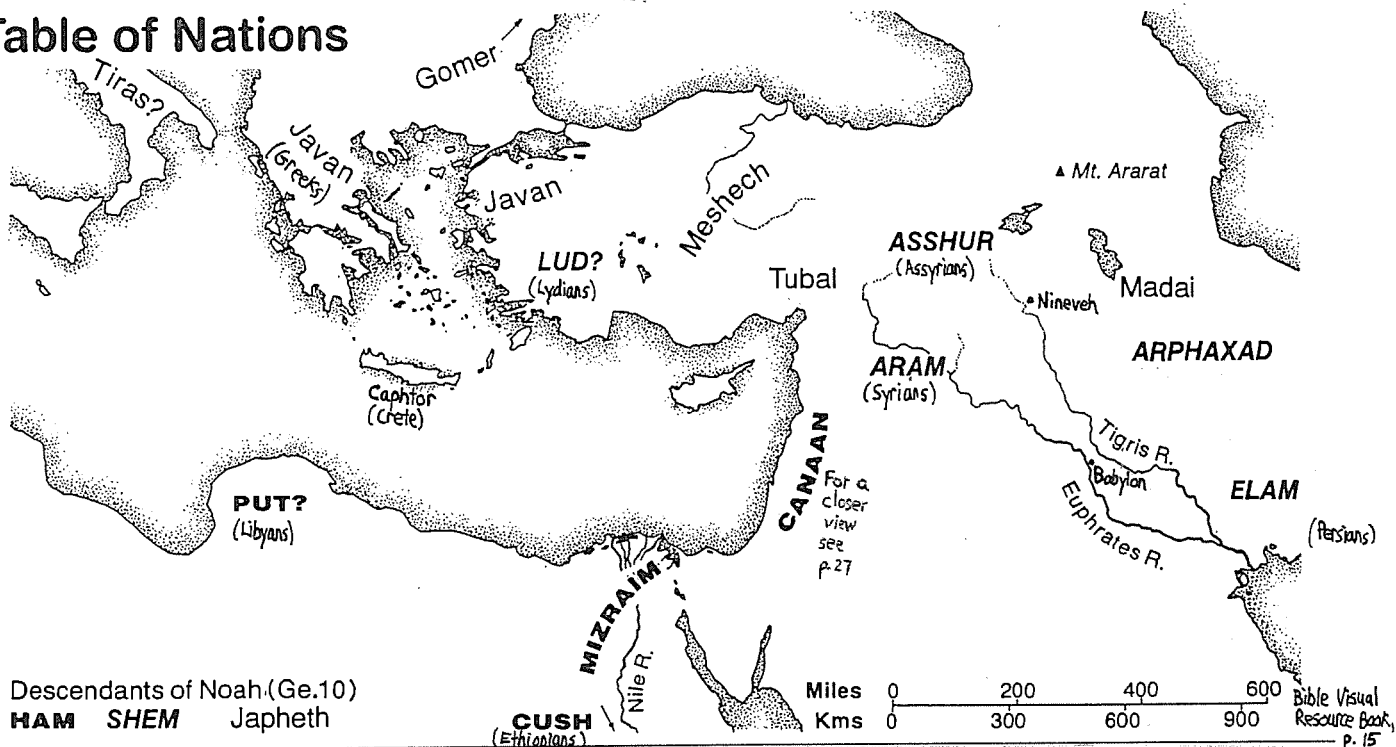

All people on earth trace their lineage from Noah, so there is really only one race—the *human* race! After a southward descent from Mt. Ararat, people tried to build a tower at Babel and were dispersed.

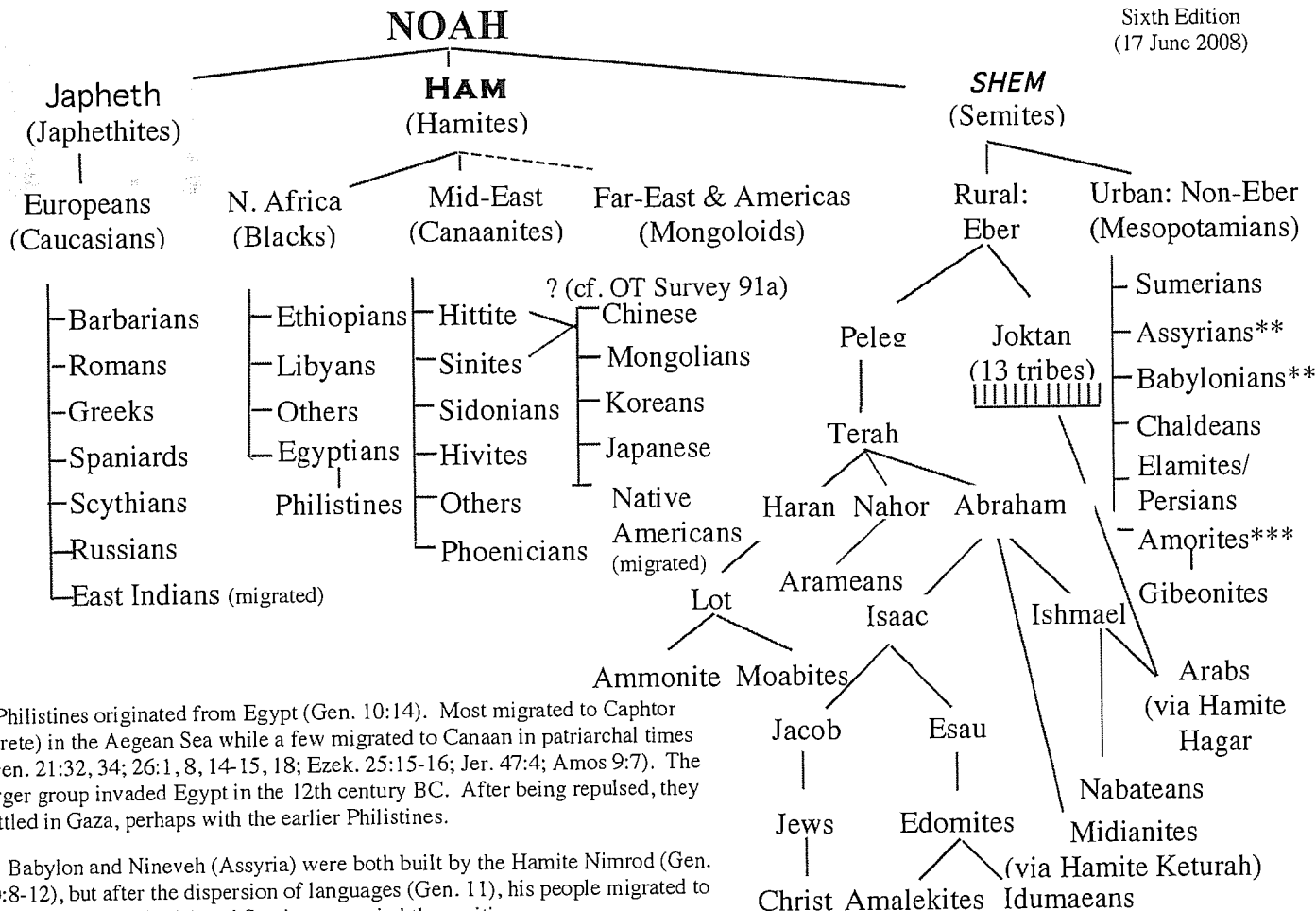

\* Philistines originated from Egypt (Gen. 10:14). Most migrated to Caphtor (Crete) in the Aegean Sea while a few migrated to Canaan in patriarchal times (Gen. 21:32, 34; 26:1, 8, 14-15, 18; Ezek. 25:15-16; Jer. 47:4; Amos 9:7). The larger group invaded Egypt in the 12th century BC. After being repulsed, they settled in Gaza, perhaps with the earlier Philistines.

\*\* Babylon and Nineveh (Assyria) were both built by the Hamite Nimrod (Gen. 10:8-12), but after the dispersion of languages (Gen. 11), his people migrated to Cush (modern Ethiopia) and Semites occupied these cities.

\*\*\* Amorites (Arameans) in Syria migrated SW (to Canaan) and SE (to Mesopotamia); cf. H. A. Hoeffner, "Amorites," ZPEB, 1:141.

Sources: Gen. 5; 10; 25:1-4; 36; 1 Chron. 1:19-23; Paul Benware, *Survey of the OT*, 264-74; Barry Beitzel, *The Moody Atlas of Bible Lands*, 76-79; Louis Hamada, *Understanding the Arab World*, 42, 51, 56; R. Laird Harris, "Genealogy," ZPEB, 2:673; Eugene Merrill, *Kingdom of Priests*, 25-32; Henry Morris, *The Genesis Record* (<http://www.csinfo.org>); NIV Study Bible, 21; John Whitcomb, *Chronological & Background Charts of the OT*, 2d ed., 71, 73 (OTS, 143-44); John Whitcomb & Henry Morris, *The Genesis Flood*, 45-54.

# The Land of Abraham

*The Bible Visual Resource Book, 15*

## Land of Abraham

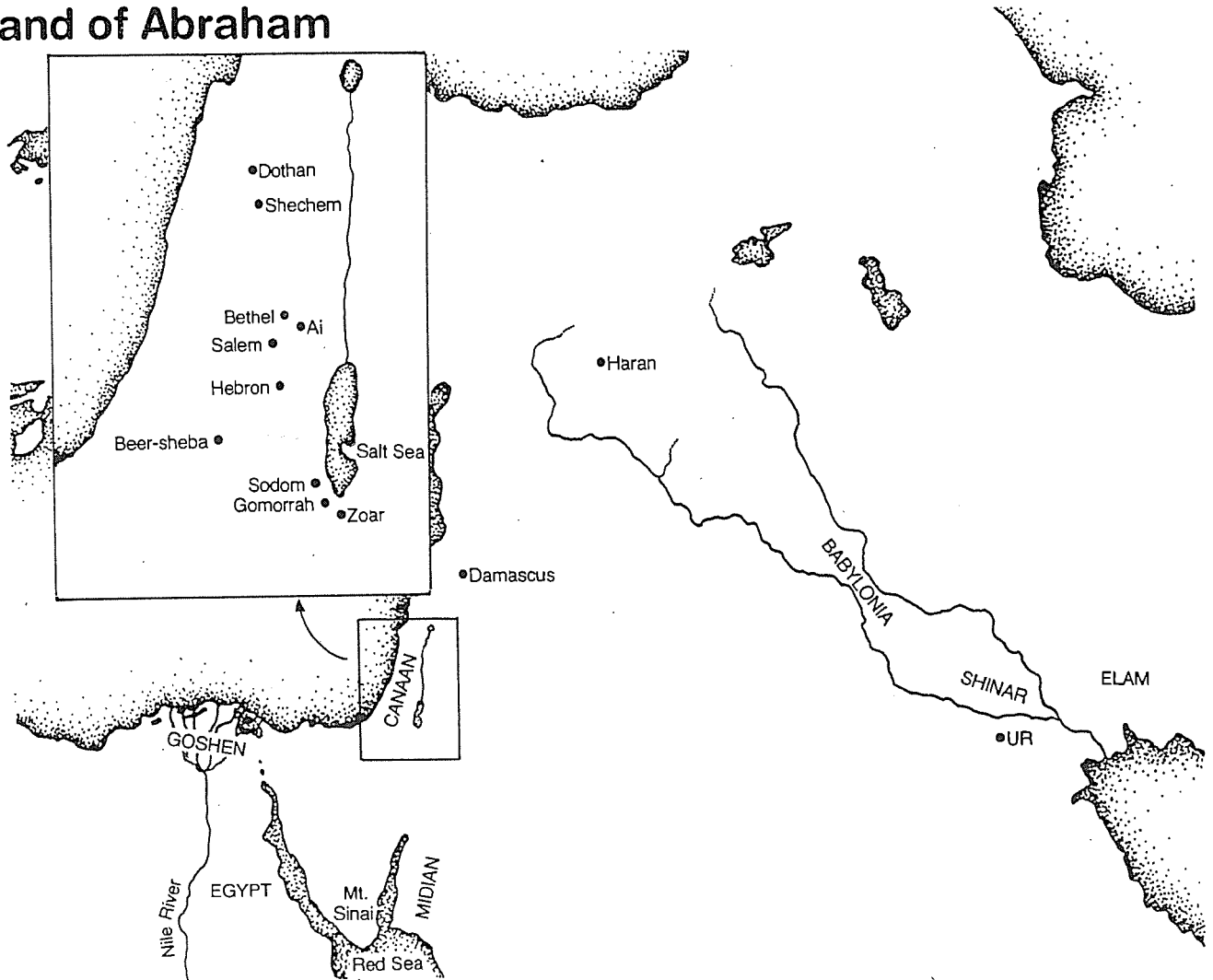

© 1989 by Gospel Light Publications. Permission granted to purchaser to reproduce this Sheet for class purposes only.

# Jacob's Journey and Tribes of Israel

Genesis

The Bible Visual Resource Book, 16

## Jacob's Journey

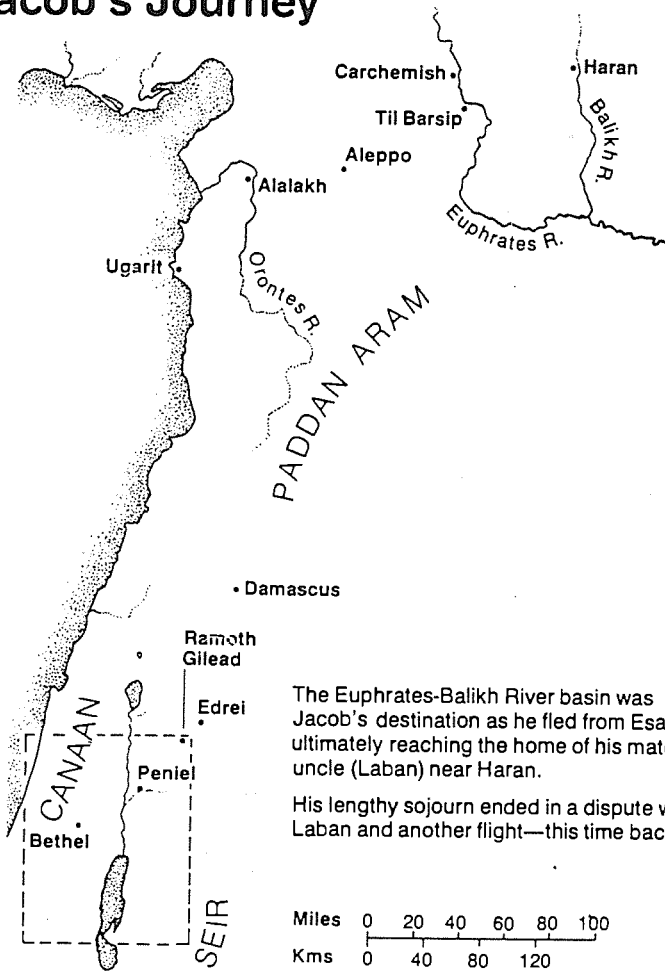

The Euphrates-Balikh River basin was Jacob's destination as he fled from Esau, ultimately reaching the home of his maternal uncle (Laban) near Haran.

His lengthy sojourn ended in a dispute with Laban and another flight—this time back to

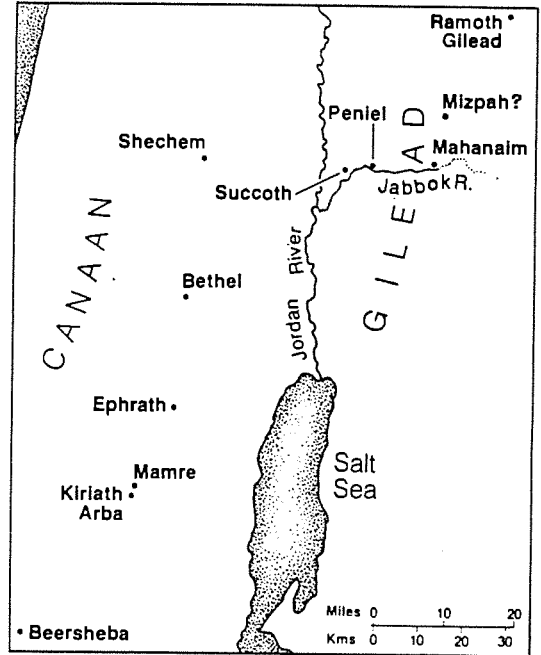
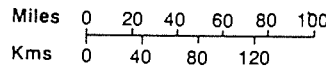

Canaan. His route likely took him toward Aleppo, then to Damascus and Edrei before reaching Peniel on the Jabbok River.

He and his dependents reached the hill country of Gilead before their caravan was overtaken by Laban. The covenant at Mizpah was celebrated on one of the hills later used as a border station between Aramean and Israelite territories.

Jacob tarried at Succoth, entered Canaan and proceeded to Shechem, where he erected an altar to the Lord.

## The Tribes of Israel

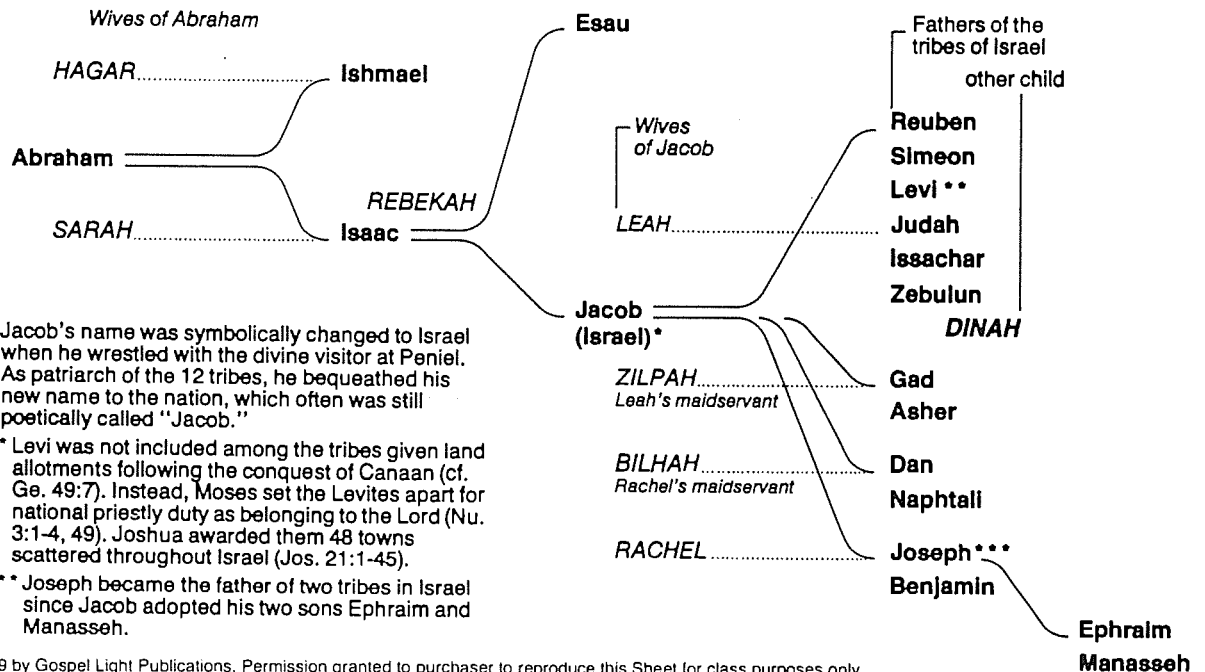

\* Jacob's name was symbolically changed to Israel when he wrestled with the divine visitor at Peniel. As patriarch of the 12 tribes, he bequeathed his new name to the nation, which often was still poetically called "Jacob."

\*\* Levi was not included among the tribes given land allotments following the conquest of Canaan (cf. Ge. 49:7). Instead, Moses set the Levites apart for national priestly duty as belonging to the Lord (Nu. 3:1-4, 49). Joshua awarded them 48 towns scattered throughout Israel (Jos. 21:1-45).

\*\*\* Joseph became the father of two tribes in Israel since Jacob adopted his two sons Ephraim and Manasseh.

## STUDY-GRAPH

Third Revised Edition

© 1965, 1968 by  
JOHN C. WHITCOMB, JR.

## Chart of Old Testament Patriarchs and Judges

Published by  
BMH BOOKSP. O. Box 544  
Winona Lake, IN 46590

JOHN C. WHITCOMB, Th.D.

Professor of Theology and Old Testament  
Grace Theological Seminary  
Winona Lake, Indiana

## INTRODUCTION

The chronological framework of biblical events from the time of Abraham to David rests upon two pivotal texts of Scripture. The first is I Kings 6:1, which dates the exodus from Egypt in the 480th year before the fourth year of Solomon. If we follow Edwin R. Thiele's date of 931 B.C. for the end of Solomon's 40-year reign (*The Mysterious Numbers of the Hebrew Kings*, 2d ed.; Grand Rapids: Eerdmans, 1965), the exodus must have occurred in 1445 B.C. by inclusive reckoning.

The second pivotal date for the biblical chronology of this period is Exodus 12:40 (Hebrew text), which dates the arrival of Jacob's family in Egypt 430 years before the exodus, or in the year 1875 B.C. The Apostle Paul's figure of "about 450 years" in Acts 13:19 (ASV; the AV incorrectly puts this phrase in the middle of verse 20), refers to 400 years "in the land of Egypt" (v. 17), using round numbers as in Genesis 15:13 and Acts 7:6; 40 years "in the wilderness" (v. 18); and 7 years conquering "seven nations in the land of Canaan" (v. 19). See F. F. Bruce, *Commentary on the Book of Acts* (Grand Rapids: Eerdmans, 1954), pp. 268, 272.

Since Jacob was 130 years old when he entered Egypt (Gen. 47:9, 28), and Joseph was 39 (Gen. 41:46-47; 45:8), Jacob must have been 91 when Joseph was born (Gen. 30:25; 31:41). Jacob himself was born in 2005 B.C. (130 years before he entered Egypt in 1875 B.C.). Isaac was 60 when Jacob was born (Gen. 25:26), and Abraham was 100 when Isaac was born (Gen. 21:5). Therefore, Abraham was born in the year 2165 B.C. For a recent discussion of the chronology of the period from Adam to Abraham, see "Genesis 11 and the Date of the Flood," Appendix II in *The Genesis Flood* by J. C. Whitcomb, Jr., and H. M. Morris (Nutley, N. J.: Presbyterian & Reformed, 1960).

In spite of the clear statement of I Kings 6:1 that the exodus occurred 480 years before the construction of Solomon's temple, as well as the impossibility of compressing the period of the judges into less than 350 years (cf. Judges 11:26), the early date of the exodus (1445 B.C.) has been generally repudiated by critical scholars. It is argued that the store-city of Raameses (Exodus 1:11) could only have been built during the reign of Rameses II (1301-1234 B.C.). But if this be so, then the birth of Moses must be dated still later to allow for the lengthy events of Exodus 1:12-22, and the exodus itself could not have occurred until 80 years after that (Exodus 7:7). This would allow little more than 100 years for the conquest of Canaan, the period of the judges, and the reign of Saul! Such a late date for the exodus not only contradicts the book of Judges, but also I Chronicles 6:33-37, which puts sixteen generations between Korah (who rebelled against Moses) and Heman (one of David's choir directors).

Recently, however, it has been pointed out that Rameses and other Pharaohs of the 19th Dynasty used names employed by the Hyksos kings in Egypt (c. 1720-1570 B.C.), and even worshiped gods honored by the Hyksos, so that Hyksos kings could have built a city named Raameses. Another objection to the early date of the exodus is that 18th Dynasty Pharaohs had their capital at Thebes, far to the south of Goshen where

the Hebrews lived. But both Thutmose III (Pharaoh of the oppression) and Amenhotep II (Pharaoh of the exodus) built extensively in the Delta and thus could have had a palace and court in the vicinity of the land of Goshen. For a recent presentation of biblical and archaeological evidence in support of a Middle Kingdom (c. 1900-1780 B.C.) date for the entrance of Joseph and Jacob into Egypt and for the early date of the exodus, see John Rea, "The Time of the Oppression and the Exodus" and "New Light on the Wilderness Journey and the Conquest," *Grace Journal* (Winona Lake, Ind.: Grace Theological Seminary), Winter and Spring, 1961. See also John Rea, "The Historical Setting of the Exodus and the Conquest" (unpublished doctoral dissertation, Grace Theological Seminary, 1958), and Gleason L. Archer, *A Survey of Old Testament Introduction* (Chicago: Moody, 1964).

Assuming that 1445 B.C. is the correct date for the exodus, we must now turn to the complex chronology of the Hebrew judges. Joseph Wesley Schmidt, "The Joshua-Judges Chronology" (unpublished doctoral dissertation, Central Baptist Theological Seminary, 1954), considers Jephthah's reference to 300 years of Israelite occupation of the Transjordan region preceding the Ammonite attack (Judges 11:26) to be of great chronological significance, because his statement was made in an official diplomatic parley. Since the Transjordan region was conquered 40 years after the exodus, the Ammonite oppression would have commenced in the year 1105 B.C. according to this reckoning. However, a simple totaling of the known periods from 1405 B.C. to 1105 B.C. (7 years of conquest, 53 years of oppressions, and 248 years of judgeships) gives a total of 308 years and still does not allow for the unknown period of Joshua and the elders which followed the 7-year conquest.

To solve this problem, Dr. Schmidt proposed an overlapping of Jabin's oppression with the last twenty years of Ehud's judgeship because (1) the 80-year period of rest which followed Ehud's victory was twice as long as any other, and it seems unlikely that Ehud would have lived throughout this period; (2) the beneficent effects of Ehud's victory over Moab could well have continued in the East and South while Jabin oppressed Israel in the North; (3) an overlapping of oppressions and victory "rests" is not entirely without precedent, for Shamgar smote Philistine oppressors and saved Israel between the victories of Ehud and Deborah (Judges 3:31; 5:6). This 20-year overlapping allows 7 years for the conquest, 11 years for Joshua and the elders between the year 1398 B.C. and the beginning of Cushan's oppression, and an additional six years may be gained by assuming a one-year adjustment for each pair of distinct periods from Cushan to the Ammonite oppression. Seventeen years, or even eleven, would seem to be adequate for this period immediately following the 7-year conquest, in view of the fact that C. F. Keil argued effectively for only ten years (*Biblical Commentary on the Old Testament: Joshua, Judges, Ruth*, Grand Rapids: Eerdmans, reprinted 1950, pp. 290-92).

Another important contribution of Schmidt's dissertation is his emphasis upon the 40-year Philistine oppression (Judges 13:1) as a connecting link between the

chronologies of the books of Judges and I Samuel. Schmidt points out (in opposition to Keil, *op. cit.*, pp. 279-82) that the Philistine oppression followed immediately after the Ammonite oppression: (1) The Ammonites are mentioned second in Judges 10:7 because their oppression is described in the passage immediately following. (2) The Philistines are not mentioned again until Judges 13:1 where the phraseology suggests an oppression subsequent to that of Ammon. (3) Judges 10:9 indicates an extension of Ammonite power west of the Jordan, which would be unlikely if the Philistines were occupying the west-Jordan region at the same time. (4) The loss of 42,000 men by Ephraim in their struggle with Jephthah following his defeat of Ammon (Judges 12:1-6) would certainly have invited the conquest of the west-Jordan region by the Philistines later that year.

Once the 40-year Philistine oppression is seen as following immediately upon the 18-year Ammonite oppression (rather than starting at the same time), an important chronological key is provided for the judgeships of Eli, Samuel and Samson. Since the end of the Philistine oppression coincides with Samuel's victory at Ebenezer (I Sam. 7:12-14), we may date this event at 1047 B.C. (18 plus 40 years after the beginning of the Ammonite oppression in 1105 B.C.). The ark remained at Kirjath-jearim for twenty years before this victory (I Sam. 7:2), so Eli's death must have occurred in 1067 B.C. when the ark was captured.

It seems highly probable that Samson's death occurred shortly before Samuel's victory at Ebenezer, and that the destruction of the Philistine nobility gathered in the temple of Dagon (Judges 16:27) gave Israel the opportunity it needed. Samson's entire life, including twenty years of judgeship, was lived within the 40-year Philistine oppression (cf. Judges 13:5), so he must have died shortly before its termination (cf. Keil, *op. cit.*, pp. 282-83). The nature of his life and work (like that of Shamgar) demands that another judge would be serving elsewhere in the west-Jordan region at the same time.

The date for the beginning of Saul's reign is determined by working back from Thiele's date of 931 B.C. for the division of the kingdom. We learn from Acts 13:21 that Saul's reign lasted 40 years; but this may be considered as the duration of his dynasty, which ended with the death of Ishbosheth seven years after his own death on Mt. Gilboa (cf. Hebrew text of I Sam. 13:1 with II Sam. 2:10). Even though Saul was the anointed king of Israel, however, Samuel continued to minister as judge in central Palestine until nearly the end of Saul's reign (I Sam. 7:15; 25:1).

For Egyptian chronology during the second millennium B.C., see George Steindorff and Keith C. Seele, *When Egypt Ruled the East* (Chicago: University of Chicago, 1957); Jack Finegan, *Light from the Ancient Past* (2d ed.; Princeton: Princeton University, 1959), pp. 89-122; William C. Hayes, *The Cambridge Ancient History* (Cambridge: Cambridge University, rev. ed., 1962).

Order the paper edition of this chart (18" x 25") from BMH Books, Box 544, Winona Lake, IN 46590; or Dr. John C. Whitcomb, Grace Seminary, Winona Lake, IN 46590.

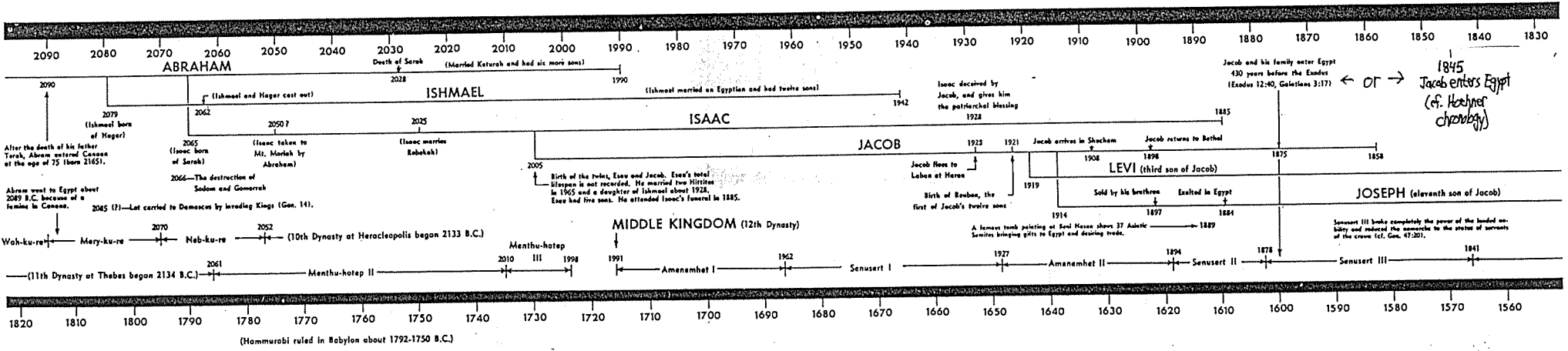

### OLD TESTAMENT PATRIARCHS and JUDGES

(Using Joseph W. Schmidt's chronology for the judges)

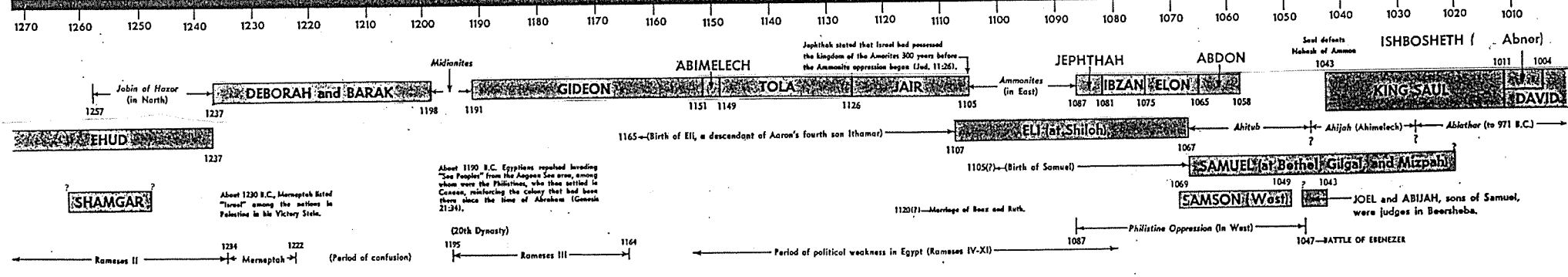
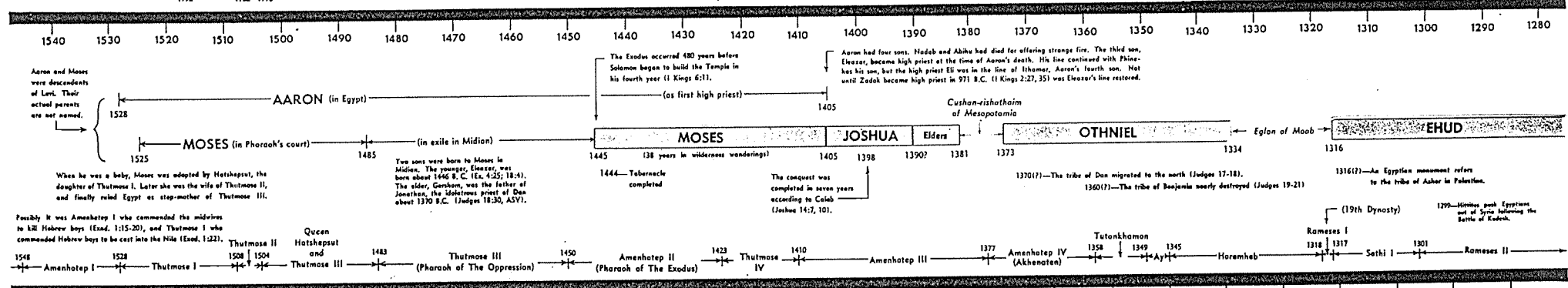
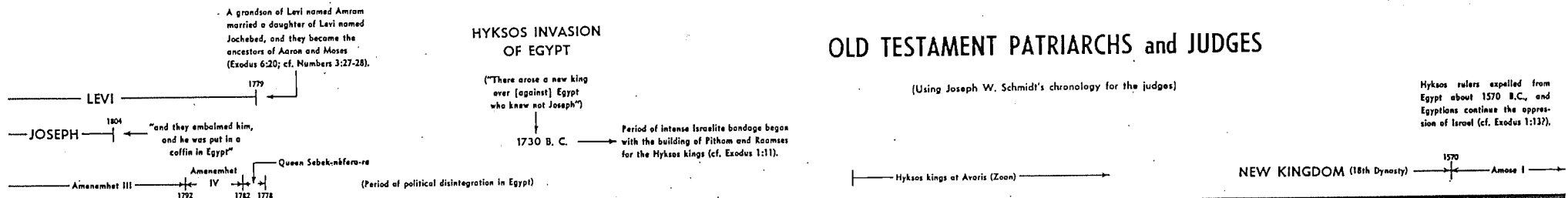



## Sons of Jacob

John H. Walton, *Chronological and Background Charts of the OT*, 2d ed., 18

MOTHER	SON	MEANING OF NAME	REFERENCE OF BIRTH (GENESIS)	ORDER OF BLESSING	SYMBOL OF BLESSING	REFERENCE OF BLESSING (GENESIS)
L E A H	Reuben	Behold, a son	29:32	1	Reckless	49:3-4
	Simeon	Hearing	29:33	2	Violence	49:5-7
	Levi	Attachment	29:34	3	Violence	49:5-7
	Judah	Praise	29:35	4	Lion	49:8-12
B I L H A H	Dan	Judgment	30:6	7	Serpent	49:16-18
	Naphtali	Wrestle	30:8	10	Doe	49:21
Z I L P A H	Gad	Good fortune	30:11	8	Raider	49:19
	Asher	Happy	30:13	9	Rich food	49:20
L E A H	Issachar	Reward	30:18	6	Donkey	49:14-15
	Zebulun	Abode	30:20	5	Ships	49:13
R A C H E L	Joseph	May he add	30:24	11	Fruitful	49:22-26
	Benjamin	Son of the right hand	35:18	12	Wolf	49:27

<b>GENESIS</b>	<b>EXODUS</b>
<b>Creation</b>	<b>Redemption</b>
<b>Begins with God</b>	<b>Begins with man</b>
<b>Ends with man</b>	<b>Ends with God</b>
<b>Hebrew family</b>	<b>Hebrew nation</b>
<b>Royal priest</b>	<b>Royal priest</b>
<b>Melchizedek</b>	<b>Aaron</b>
<b>Covenants</b>	<b>Commandments</b>
<b>Lamb is promised</b>	<b>Lamb is provided</b>
<b>Emphasis on Land</b>	<b>Emphasis on Law</b>
<b>God's promises</b>	<b>God's precepts</b>
<b>Grace</b>	<b>Government</b>

*by Huang Sabin, SBC (adapted)*

Ex: Additional Background

# Exodus

## Formation into a Nation Begun

Chapters 1—18				Chapters 19—40			
Receive Freedom from Slavery				Receive Law from God			
Getting Israel Out of Egypt				Getting Egypt Out of Israel			
Narration				Legislation			
Free People				Government			
Subjection		Deliverance		Instruction			
Egypt		Wilderness		Sinai			
400 Years		2 Months		10 Months			
Toil & Confrontation (1—11)		Redemption & Protection (12—18)		Covenant Revealed (19—31)		Covenant Ratified (32—40)	
Moses as Returned Fugitive		Moses as Wilderness Leader		Moses as Intermediary		Moses as Lawgiver	
Preparation (1:1—7:13)	Plagues (7:14—11:10)	Memorials (12:1—15:21)	Provisions (15:22—18:27)	Preparation (19)	3-Part Covenant (20—31)	Broken & Renewed (32—34)	Tabernacle Built/Filled (35—40)

**Key Word:** Formation

**Key Verse:** “Now if you obey me fully and keep my covenant, then out of all nations you will be my treasured possession. Although the whole earth is mine, you will be for me a kingdom of priests and a holy nation” (Exodus 19:5-6)

**Summary Statement:**

Israel's formation as a nation begins under God as King by a miraculous redemption from Egypt and revelation of the Mosaic Law to provide a kingdom over which a descendant of Judah could rule and to promote holiness and trust in God.

**Application:**

We as believers need to remember God's provisions to form us into a people of God (Christ's death) and to make us individual believers in Christ (specific events God has accomplished on your behalf).

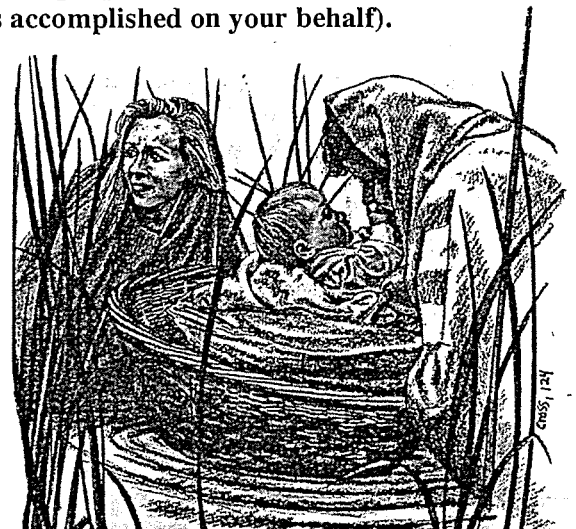
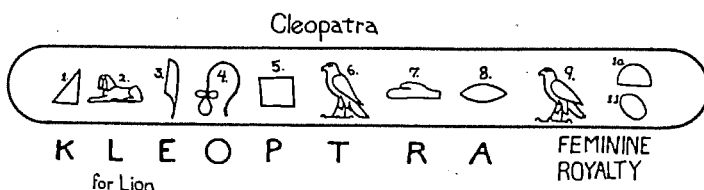

A cartouche is an oval area inscribed with the name of the country's ruler. This cartouche shows the hieroglyphics for Cleopatra's name and indicates she was a powerful ruler.

# Exodus

## Introduction

**I. Title** The Hebrew title for Exodus is "And These Are the Names" (וְאֵלֶּה שְׁמוֹת *we'elleshemoth*), taken from the first phrase which follows ancient custom for naming a text (LaSor, 131). The English title *Exodus* ("a going out") transliterates the Septuagint title *Exodus*, a compound word composed of ἐκ, "out," and ὁδός, "way," meaning an exit, departure, or going out. Although Israel's departure from Egypt constitutes only a few chapters, this is a major emphasis in the book and therefore is a fitting title.

## II. Authorship

- A. **External Evidence:** Both Scripture and tradition have attributed the authorship of Exodus to Moses since the time of Joshua (Josh. 8:30-32). Other persons in Scripture name Moses as author, including Malachi (Mal. 4:4), the disciples (John 1:45), Paul (Rom. 10:5) and, most importantly, Christ Himself (Mark 7:10 quotes Exod. 3:6; 12:26; cf. Luke 20:37; John 5:46-47; 7:19, 22-23). Jewish and Samaritan traditions held to Mosaic authorship as well, although early in the Christian era some theologians vacillated between Moses and Ezra as the author of the entire Pentateuch (Ross, *BKC*, 1:15).
- B. **Internal Evidence:** Portions of Exodus are directly attributed to Moses (ch. 15; 17:8-14; 20:1-17; 24:4, 7, 12; 31:18; 34:1-27). This makes sense since no one else could have been better qualified than Moses to write the book. "Moses was educated in all the wisdom of the Egyptians" (Acts 7:22) and had the literary skills necessary to compose such a work. The author definitely was an eyewitness of the Exodus as the book shows acquaintance with the customs and climate of Egypt as well as the plants, animals, and terrain of the wilderness (*TTTB*, 13). The book also evidences a consistency of style characteristic of a single author.

## III. Circumstances

- A. **Date:** Mosaic authorship of Exodus places the writing during his lifetime (1525-1405 BC). More specifically, Exodus covers Israel's history only up to the encampment at Mt. Sinai in 1444 BC, assuming the early date of the Exodus. It is logical that Moses would have recorded these incidents shortly after these events took place in 1444 BC.
- B. **Recipients:** Moses died before Israel entered the Promised Land so the original readers comprised the Jews in the wilderness with him.
- C. **Occasion:** Since Moses knew that he would be passing on while the nation of Israel continued for generations, he wisely and under the direction of the Spirit recorded the history of the birth of Israel as the nation that would bring God's rule on the earth (*TTTB*, 14). This historical work was written to provide the nation a lasting remembrance of God's work on its behalf, especially in its deliverance from Egypt.

## IV. Characteristics

- A. Many Bible students are fooled by the title of the book, thinking that Exodus records only the narrative of Israel's redemption from Egypt. The fuller understanding is that Exodus contains more information about the Passover, the Law, and the tabernacle than any book in Scripture. Exodus lays the foundation for the entire Mosaic Law.
- B. The date of the Exodus falls into two scholarly camps: late date advocates who postulate a 13th century BC Exodus (ca. 1290 BC, in the reign of Rameses II) and early date adherents who date it in the 15th century BC (ca. 1445 BC, in the reign of Amenhotep II). A comparison of the chronological systems supplements these Exodus notes (pp. 108-110), but the best evidence supports the early date (so more evangelicals advocate it):

1. Scriptural Evidence:
  - a. 1 Kings 6:1 claims that 480 years transpired between the beginning of Solomon's temple construction (966 BC in the fourth year of his reign) and the Exodus. This places the date at about 1446 BC.
  - b. Judges 11:26 records that Israel had been in the land for 300 years during the time of Jephthah (ca. 1100 BC). Adding the 40 year wilderness wanderings places the Exodus date in the middle of the 15th century BC.
2. Archaeological evidence from Egypt during the 15th century corresponds to the biblical record of the Exodus which includes use of bricks and huge building projects. Also, the best evidence indicates that Jericho, Ai, and Hazor were destroyed about 1400 BC.

## Argument

The Book of Exodus begins where Genesis concludes—Jacob's family in Egypt awaiting the fulfillment of God's promise initially given to Abraham. Exodus records how God intervenes to fulfill this promise by beginning to form Jacob's family into a nation which operates under God's own rule as a theocracy.

In order to become a nation Israel needed three things: (1) freedom, (2) a charter/government, and (3) land. Exodus records two of these three necessities. First, Israel must be free from foreign control to be under God's rulership, so Moses records the nation's miraculous redemption from Egyptian bondage in the Exodus (chs. 1—18). Second, the redeemed nation must have its own charter under which God may rule, so the latter half of the book reveals the Mosaic Covenant and the nation's agreement to its terms (chs. 19—40). The only characteristic of a nation lacking is a land, which is secured in the Book of Joshua. The final verses (40:34-38) demonstrate that God accepts the Covenant by agreeing to dwell among the people as King. Exodus does not simply record historical events, but does so with the purpose of revealing Israel's sin and motivating the people to trust in God who demonstrates His sovereignty over Egypt and faithfulness to His covenant given to Abraham.

## Synthesis

### Formation into a nation begun

### National Elements:

1–18

### Receive Freedom

People

1–11

Toil and Moses confronts Pharaoh

1

Redemption needed

2–4

Moses prepared

5–11

The LORD introduced in confrontation

5:1–6:12

Words - Work

6:13-27

Genealogy

6:28–7:13

Rods

7:14–11:10

Plagues

7:14-25

1 Blood

8:1-15

2 Frogs

8:16-19

3 Gnats

8:20-32

4 Flies

9:1-7

5 Livestock

9:8-12

6 Boils

9:13-35

7 Hail

10:1-20

8 Locusts

10:21-29

9 Darkness

11

10 Firstborn

12–18

Redemption and protection

12:1–15:21

Memorials

12

Passover

MOSES' LIFE			
Period	Reference	Dates	Location
40 years Prince	Exod 2:1-10	1525-1485 B.C.	Egypt
40 years Shepherd	Exod 2:11- 25	1485-1445 B.C.	Midian
40 years Leader	Exod 3:1- Deut 34:8	1445-1405 B.C.	Midian Egypt Wilderness

13:1-16	Consecration
13:17-14:31	Sea
15:1-21	Songs
15:22-18:27	Wilderness provisions
15:22-27	Marah/Elim water
16	Manna/Quail/Sabbath
17:1-7	Rock water
17:8-16	Amalekites
18	Jethro

19-40	Receive Law	Government
19-31	Covenant revealed	
19	Preparation	
20-31	Covenant in three parts:	
20:1-21	1 Decalogue	
20:22-24:18	2 Book of the Covenant—holiness	
25-31	3 Ceremonial regulations—worship via priests	
25-27	Tabernacle	
28-29	Priests	
30-31	Service/Sabbath	
32-40	Covenant ratified	
32	Israel breaks	
33-34	God renews	
35-40	Tabernacle built/filled	

## Outline

### Summary Statement for the Book

**Israel's formation as a nation begins under God as King by a miraculous redemption from Egypt and revelation of the Mosaic Law to provide a kingdom over which a descendant of Judah could rule and to promote holiness and trust in God.**

- I. (Chs. 1—18) Israel's miraculous redemption from Egypt and preservation in the wilderness begins Israel's formation as a nation over which a descendant of Judah can rule to provide an historical record of how the nation should trust in God.
  - A. (Chs. 1—11) Israel toils in Egyptian bondage but God prepares and uses Moses to confront Pharaoh with His plan to free Israel to introduce Yahweh to the nation as concerned for it, faithful to the Abrahamic Covenant, and sovereign over the gods of Egypt.
    1. (Ch. 1) The Egyptians' forced labor of Israelites and attempt to kill their newborn boys shows Israel's need for redemption from bondage to become a nation of promise in its own land to teach the Israelites that God motivates them to resolve their plight.
    2. (Chs. 2—4) God's preparing Moses as Israel's leader, despite his own feelings of inadequacy, pictures Israel's own need to trust in God's adequacy and faithfulness to the Abrahamic Covenant.
      - a. (Ch. 2) Moses is prepared to lead Israel through his upbringing by his mother and Pharaoh's household and his self-imposed forty-year desert exile as a shepherd to convey to the nation God's preparation for fulfilling the Abrahamic Covenant.
      - b. (3:1—4:17) God calls Moses back to Egypt to lead Israel out and he complains of his inadequacy to remind Israel that, due to its own inadequacy, Israel needs to trust in God's adequacy as it anticipates conquering the Promised Land.
      - c. (4:18-31) Moses returns to Egypt and is accepted by Israel as leader to recall for the nation God's concern for the suffering of His people.

3. (Chs. 5—11) Moses introduces Yahweh to Israel by confronting Pharaoh with words and miracles which assert God's plan to lead Israel from Egypt but Pharaoh refuses, which reminds Israel of God's sovereignty over Pharaoh and the gods of Egypt.
  - a. (5:1—6:12) Moses confronts Pharaoh with words alone but Israel receives an added workload and Moses despairs at being rejected by the Israelite foremen to teach Israel the cost sometimes involved in following the sovereign LORD.
  - b. (6:13-27) The genealogy of Moses and Aaron is provided to identify their prominent position before Pharaoh and to demonstrate to Israel their authority as representatives of the people.
  - c. (6:28—7:13) Moses confronts Pharaoh with the miracle of Aaron's rod turned into a snake, then Pharaoh's magicians duplicate it but their snakes are eaten by Aaron's to show the superior and sovereign power of the LORD.
  - d. (7:14—11:10) Moses confronts Pharaoh with ten plagues which demonstrate the sovereignty of the LORD over the gods of Egypt (cf. 12:12) as a reminder to Israel of the nation's need to rely upon God rather than its own strength.
    - 1) (7:14-25) The turning of all water in Egypt into blood proves God's sovereignty over Hapi (god of the Nile), Khnum (guardian of the river's source), Osiris (Nile was his bloodstream), Hapi (god of crocodiles), and various fish-deities.
    - 2) (8:1-15) The plague of frogs shows God sovereign over Heqet, goddess of birth (frog head).
    - 3) (8:16-19) The plague of gnats shows God sovereign over Set, god of the desert (earth).
    - 4) (8:20-32) The plague of flies shows God sovereign over Re, a sun god (or possibly the god Uatchit, possibly represented by the fly).
    - 5) (9:1-7) The death of only Egypt's livestock shows God sovereign over Hathor (goddess with a cow head), Apis (bull god and symbol of fertility), and other gods associated with bulls and cows.
    - 6) (9:8-12) The plague of boils shows God sovereign over Sekhmet (goddess of power over disease), Sunu (pestilence god), and Isis (goddess of healing).
    - 7) (9:13-35) The plague of hail, thunder and lightning shows God sovereign over Nut (sky-goddess), Osiris (god of crops and fertility), Set (god of storms), and Shu (god of the atmosphere).
    - 8) (10:1-20) The plague of locusts shows God sovereign over Serapia (protector of locusts), Nut (sky goddess), and Osiris (god of crops and fertility).
    - 9) (10:21-29) The plague of darkness shows God sovereign over Re, Amon-Re, Aten, Atum, Harakite, and Horus (sun-gods), Thoth (moon-god), Nut and Hathor (sky-goddesses).
    - 10) (Ch. 11) The announcement of death upon all firstborn men and animals shows God sovereign over all of Egypt's gods, but especially Min (god of reproduction), Heqet (goddess who attended women at childbirth), Isis (goddess who protected children) and Pharaoh's firstborn son, also considered a "god."
- B. (Chs. 12—18) Israel experiences redemption from Egypt and protection by God in the desert, recorded as a memorial of God's sovereignty, ability, and concern for His people shown in freeing them to have a kingdom of their own over which a Davidic descendant can rule.

1. (12:1—15:21) Israel's redemption from Egypt is celebrated in the first Passover, consecration of the firstborn, and songs of Moses and Miriam as memorials of the LORD's demonstration of His sovereignty and concern for Israel.
  - a. (Ch. 12) The Passover plague on the firstborn and freedom from bondage demonstrates God's sovereignty and unique concern for Israel, His covenant community.
    - 1) (12:1-30) The tenth plague kills the firstborn in Egypt while Israel is redeemed through the Passover to verify God's unique concern for His people.



- 2) (12:31-43) Pharaoh demands that Israel leave that very night—exactly 430 years of sojourning in Egypt and Canaan (1875-1445 BC; cf. Samaritan Pentateuch & LXX on 12:40)—to indicate God's sovereign control over His people.
  - 3) (12:43-51) God restricts future Passover observances only to Israelites and circumcised proselytes to teach Israel that those outside the covenant community have no reason to celebrate since they are not under the blood.
- b. (13:1-16) God commands the consecration of the firstborn sons of Israel as a perpetual reminder of their deliverance by God in the tenth plague.
  - c. (13:17—14:31) The miraculous crossing of the Red Sea and death of the pursuing Egyptians demonstrates God's sovereign redemption of Israel from their power.
  - d. (15:1-21) Moses and Miriam lead Israel in praising God through songs of redemption as a permanent musical remembrance of God's sovereign work in the Exodus.
2. (15:22—18:27) Israel experiences protection by God in the initial days of the wilderness wanderings en route to Mount Sinai as evidence of God's concern for and His ability to take care of the nation.
  - a. (15:22-27) Through the miraculous sweetening of the bitter water at Marah and provision of the waters of Elim, God shows His ability and concern to protect His people from thirst.
    - b. (Ch. 16) Through the miraculous provision of manna and quail God demonstrates His ability and concern to deliver His people from hunger.



- c. (17:1-7) Through the miraculous provision of water from a rock God demonstrates His ability and concern to protect His people from thirst again.
- d. (17:8-16) Through the miraculous defeat of the Amalekites God demonstrates His ability and concern to protect His people from destruction by enemies.
- e. (Ch. 18) Through the wise counsel of Jethro God demonstrates His ability and concern to protect His people from chaos resulting from an overburdened Moses.

**II. (Chs. 19—40) Israel receives the Law then rejects it, but after Israel repents God restates and renews the covenant by filling the new tabernacle to reveal sin and motivate holiness in a kingdom with God who dwells as King.**

- A. (Chs. 19—31) God reveals His covenant to His prepared people through Moses to condemn their sinfulness in contrast to God's holiness and to motivate them to holy living in a special covenantal relationship with God.
  - 1. (Ch. 19) The people prepare to receive God's covenant on Mount Sinai by agreeing to its terms and sanctifying themselves to remind Israel of its commitment to keep the Mosaic Law as a kingdom of priests (mediators for pagan nations).
  - 2. (Chs. 20—31) The covenant is received in three parts: the Decalogue, the Book of the Covenant, and the ceremonial regulations, to condemn the nation by revealing its sinfulness in contrast to God's holiness and righteousness.
    - a. (20:1-21) The Decalogue (Ten Commandments) is given to Israel to condemn the nation by revealing its sinfulness in contrast to God's holiness and righteousness.
      - 1) (20:1-2) God summarizes His redemption of Israel from Egypt as the basis for the following commandments.
      - 2) (20:3-17) Ten commandments relating to both vertical and horizontal relationships condemn the nation by revealing its sinfulness in contrast to God's holiness and righteousness.
      - 3) (20:18-21) The people remain at a distance for fear of God.
    - b. (20:22—24:11) The Book of the Covenant provides various stipulations to motivate Israel to holy living as a theocracy.
      - 1) (20:22—23:33) Social, moral, religious, and conquest stipulations are given to motivate Israel to holy living in a special covenantal relationship with God.
      - 2) (24:1-11) The covenant is confirmed by the people, thus making Israel a theocracy—a government ruled by God.
    - c. (24:12—31:18) The ceremonial regulations delineate for Israel that proper worship must be through divinely appointed priests who serve at the tabernacle.
      - 1) (24:12-18) Moses ascends Sinai to receive two stone tablets which contain the Decalogue and commands for Israel's worship (in chs. 25—31).
      - 2) (Chs. 25—27) Instructions for the tabernacle describe its various pieces and furniture which symbolize God's dwelling among His people.
      - 3) (Chs. 28—29) Instructions concerning the divinely appointed priests specify their clothing and consecration as representatives for the people before God in the nation's religious life.

- 4) (Chs. 30—31) Instructions concerning the tabernacle service convey the proper methods for using the tabernacle and the paramount importance of the sign of the covenant—the Sabbath.

Epilogue (31:18) After God finishes explaining all the various ceremonial regulations for Israel, Moses receives the two stone tablets as a witness of the strict conformance to the covenant that God prescribes.

- B. (Chs. 32—40) Israel breaks the covenant then repents, so God renews it, then Israel obeys by building the tabernacle and witnesses God's pleasure in filling it, these events demonstrating the gracious hand of God who dwells as King.
  1. (Ch. 32) Israel willingly breaks the covenant by worshipping a golden calf it makes only forty days after agreeing to follow the LORD's covenant (cf. 24:3) which includes not making idols (cf. 20:4-6), recorded to teach the nation not to revert to old ways.
  2. (Chs. 33—34) God renews the covenant after Israel repents and Moses prays for the nation to teach Israel that God is faithful to His promises.
    - a. (33:1-6) The people repent when they hear from Moses that God will not accompany them to the Promised Land.
    - b. (33:7-23) Moses prays for God's presence to attend the nation and even gets to see some of God's glory.
    - c. (Ch. 34) God renews the covenant on two new stone tablets that Moses chisels out and inscribes to teach Israel that God is faithful to His promises.
  3. (Chs. 35—40) Israel obeys the covenant by building the tabernacle exactly as God intends with the result that His very glory fills it as a sign of His guiding presence and rule as King.
    - a. (35:1—36:7) The people's obedience to the covenant is demonstrated in the abundance of offerings given to prepare for the tabernacle construction.
    - b. (36:8—40:33) The tabernacle and courtyard are built with their furnishings and priestly clothes, then inspected and erected exactly as God intends.
      - 1) (36:8-38) The tabernacle itself is constructed with its curtains, boards, and veils.
      - 2) (Ch. 37) The tabernacle furnishings are constructed: the ark, the table of showbread, the gold lampstand, and the altar of incense.
      - 3) (38:1-8) The courtyard furnishings are constructed: the altar of burnt offerings and the bronze basin.
      - 4) (38:9-20) The courtyard itself is constructed.
      - 5) (39:1-31) The priestly garments are fashioned for Aaron and his sons.
      - 6) (39:32-43) Moses inspects the tabernacle and blesses it as completed exactly as God desired.
      - 7) (40:1-33) The tabernacle is erected.
    - c. (40:34-38) God's very glory fills the tabernacle and remains in the form of a cloud as a sign of His guiding presence and rule as King.

# The Pyramids

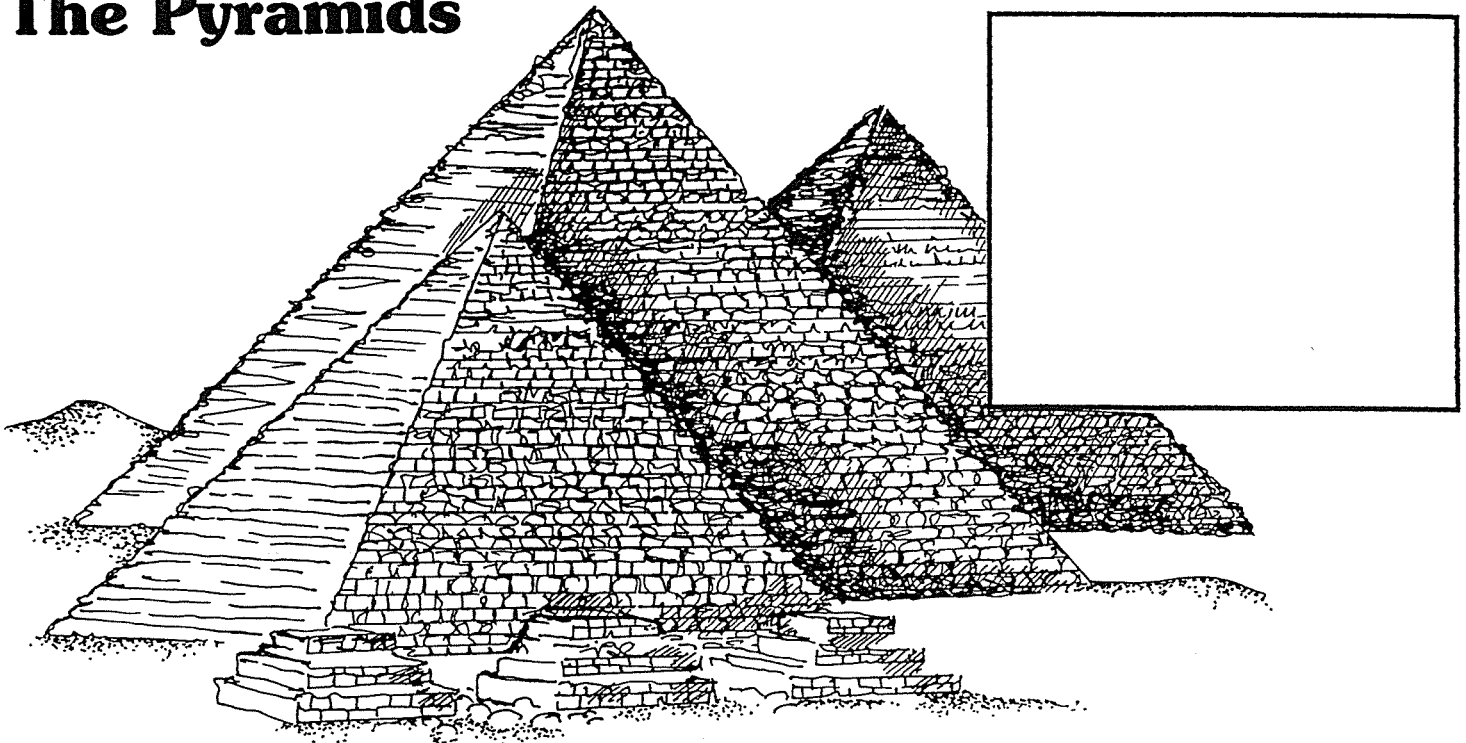

The great Egyptian pyramids served as elaborate tombs for the pharaohs. They are one of the seven wonders of the world.

1. The pyramids were built without machines. Peasant farmers built them in exchange for food, oil and cloth. Write why pyramids are a wonder of the world next to the title.
2. There are more than 30 pyramids in Egypt, but the most famous ones are located in Giza. Draw a map of ancient Egypt in the top right box. Draw a small pyramid where Giza is located.
3. The most famous pyramids were built for kings Khafre, Khufu and Menkaure. King Khufu's is known as the Great Pyramid. Label King Khufu's pyramid.
4. The chief queens of the three kings were buried in the small pyramids. Do you think if pyramids were still being built, that women's pyramids would be this size today? Write why on the back of this page.
5. King Khufu's pyramid is 147 meters high. Write how many feet this is at the bottom of his pyramid.
6. Each pyramid block weighed an average of 2,300 kilograms. Write how many pounds this is above the pyramids.
7. King Khafre's pyramid has about 2,300,000 blocks. Write how many pounds of rock this is under the number of pounds each block weighs.
8. The large blocks were dragged on sledges. Wheels were not used at all! Draw a sledge under the map.
9. There were so many blocks leftover from building the Great Pyramid, that the builders decided to build the Great Sphinx. Draw it to the left of the pyramids.
10. On the back of this paper, write why you think the U.S. has no pyramids.

# Hieroglyphics

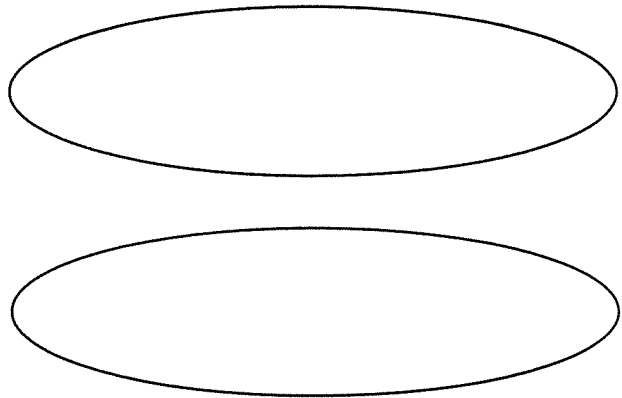
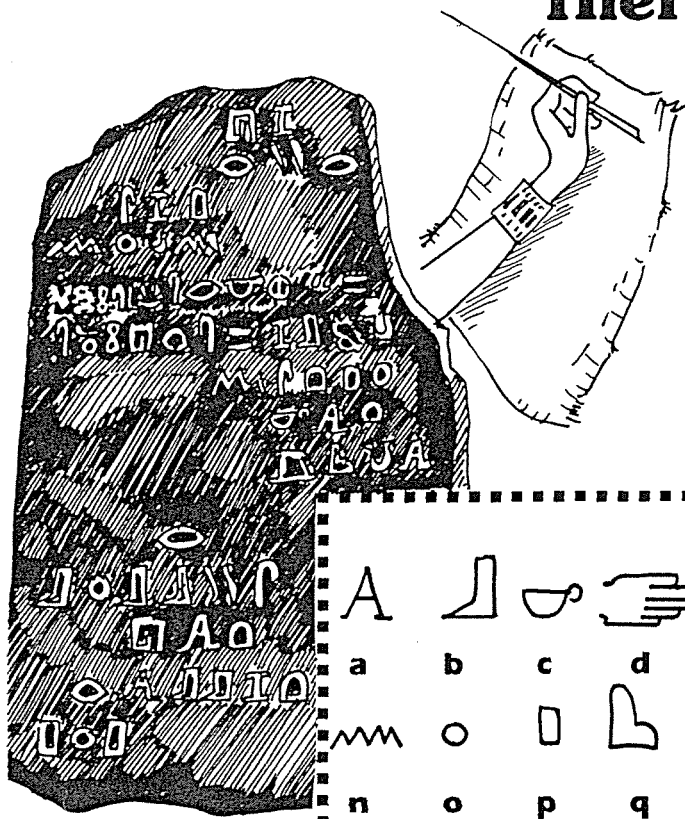

Hieroglyphics is a form of writing used by the ancient Egyptians in which picture symbols represent ideas and sounds. This type of writing was first done on stone.

1. The Rosetta Stone, a slab in which a decree is carved in hieroglyphics, gave the world the key to the understanding of this writing when it was found in 1799. Under the stone, write how many years ago this was found.
2. Egyptians also wrote on a type of paper made from the papyrus reed that grew along the Nile. Write the plural of papyrus under the title.
3. For legal documents and everyday records, the Egyptians invented demotic script. This was a simpler version of hieroglyphics. Next to the title, write why you think they wanted something simpler.
4. From about 3000 B.C. onward, each year in Egypt was named after an important event. Write what you would call the current year to the left of the title.
5. Use the hieroglyphics above to write your mother's name at the bottom of this page. Note: Capital letter vowels are represented as we know them since there were no vowels in hieroglyphics.
6. A cartouche was an oval frame enclosing the name of a ruler. Write your name in hieroglyphics in one of the ovals above.
7. Write the name of your best friend in hieroglyphics in the other oval.
8. Cartouches are often seen on monuments as nameplates of ancient rulers. On the back of this paper, design a monument including your cartouche.
9. Circle three proper nouns on this page.
10. On another piece of paper, write a letter to a classmate using hieroglyphics.

For a fun way to study this language purchase the kit and book by Catharine Roehrig, *Fun with Hieroglyphics* (New York: The Metropolitan Museum of New York and Viking, A Member of Penguin Putnam, Inc., 375 Hudson Street, New York, New York 10014, USA, ©1990). It has 24 rubber stamps, an ink pad, and a guidebook for US\$22.50.

## How Hieroglyphics Were Deciphered

P. Kyle, McCarter, Jr., *Ancient Inscriptions: Voices from the Biblical World* (Washington, DC: Biblical Archaeology Society, 1996), 35

### ROSETTA STONE

In July 1799, in the aftermath of the French invasion of Egypt, a detail of Napoleon Bonaparte's troops was dispatched to build a fort on the left bank of the western or Rosetta branch of the Nile. The site was not far from the town of Rosetta (Arabic Rashid, ancient Bolbetine), situated about nine miles south-southeast of the Rosetta mouth, where the Nile empties into the Mediterranean Sea. While digging foundation trenches for the fort, the soldiers uncovered an ancient wall containing a large, broken slab of black basalt inscribed with ancient writing. Though reused as a building block in the construction of the wall, the Rosetta Stone, as it is called, is a fragment of a commemorative stela, which once stood in an Egyptian temple. It records the text of a decree issued in 196 B.C.E. at Memphis by an assembly of Egyptian priests extolling the deeds and virtues of King Ptolemy V Epiphanes (210–180 B.C.E.) and prescribing that copies of the decree should be displayed in temples throughout Egypt. In its unbroken condition, the Rosetta Stone was probably more than 4 feet high, but what remains is approximately 3 feet 10 inches high, 2 feet 6 inches wide, and just under 1 foot thick; it weighs 1,676.5 pounds. After the defeat of Napoleon's army, the stone, along with other antiquities, was ceded to the British under the terms of the Treaty of Alexandria (1801). It was then shipped to England and found its way into the collection of the British Museum before the end of 1802.

The Rosetta Stone is a bilingual inscription, that is, it bears copies of the priestly decree in two languages, Egyptian and Greek. The Egyptian text, moreover, is written in two scripts, hieroglyphic and demotic, so that altogether there are three versions of the decree, which are arranged on the stone as follows: hieroglyphic at the top, demotic in the middle, and Greek at the bottom. French scholars immediately recognized that the document might be bilingual when they examined the stone in Cairo shortly after its discovery. They made and distributed copies to other scholars in Europe in the hope that comparison of the undeciphered hieroglyphic and demotic texts to the fully understood Greek version might shed light on the language and writing of ancient Egypt.

Early efforts to exploit the potential of the Rosetta Stone for the decipherment of Egyptian concentrated on comparison of the Greek text to its demotic, not hieroglyphic section. There was more than one reason for this. The middle part of the stone, where the demotic text is recorded, is nearly complete, whereas much of the upper part, which bears the hieroglyphic section, is broken away. In the early 19th century, moreover, hieroglyphic...

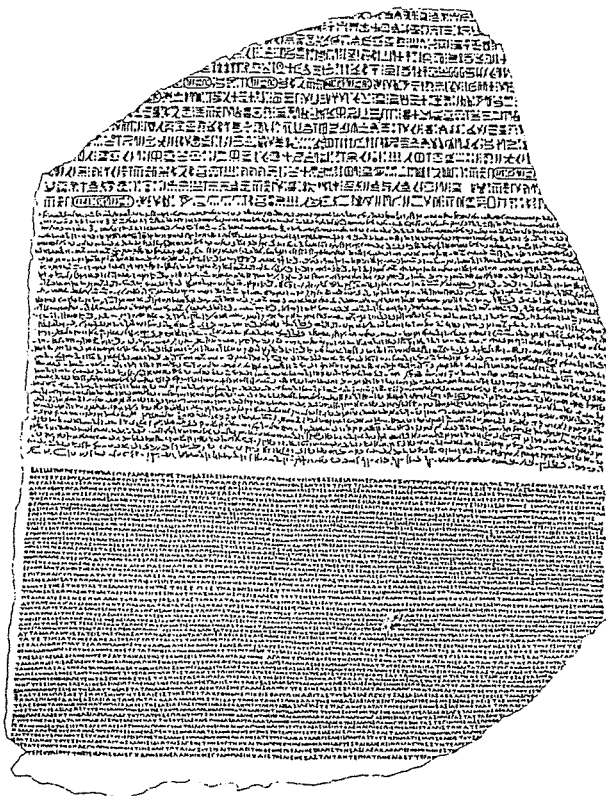

Rosetta Stone

## The Plagues and the Gods of Egypt

John H. Walton, *Chronological and Background Charts of the OT*, 2d ed., 85

PLAGUE	REFERENCE	POSSIBLE EGYPTIAN DEITY DIRECTED AGAINST
NILE TURNED TO BLOOD	Exodus 7:14-25	Khnum: guardian of the Nile Hapi: spirit of the Nile Osiris: Nile was bloodstream
FROGS	Exodus 8:1-15	Heqt: form of frog; god of resurrection
GNATS (MOSQUITOES)	Exodus 8:16-19	
FLIES	Exodus 8:20-32	
PLAGUE ON CATTLE	Exodus 9:1-7	Hathor: mother-goddess; form of cow Apis: bull of god Ptah; symbol of fertility Mnevis: sacred bull of Heliopolis
BOILS	Exodus 9:8-12	*Imhotep: god of medicine
HAIL	Exodus 9:13-35	Nut: sky goddess Isis: goddess of life Seth: protector of crops
LOCUSTS	Exodus 10:1-20	Isis: goddess of life Seth: protector of crops
DARKNESS	Exodus 10:21-29	Re, Aten, Atum, Horus: all sun gods of sorts
DEATH OF FIRSTBORN	Exodus 11:1-12:36	The deity of Pharaoh: Osiris, the giver of life

These are only some of the gods whom the plagues may have been directed against. It is not necessarily conclusive.

\*Perhaps too early for this deity to have been involved.

# Map of the Exodus

*The Bible Visual Resource Book, 23*

Exodus

## The Exodus

The exodus and conquest narratives form the classic historical and spiritual drama of OT times. Subsequent ages looked back to this period as one of obedient and victorious living under divine guidance. Close examination of the environment and circumstances also reveals the strenuous exertions, human sin and bloody conflicts of the era.

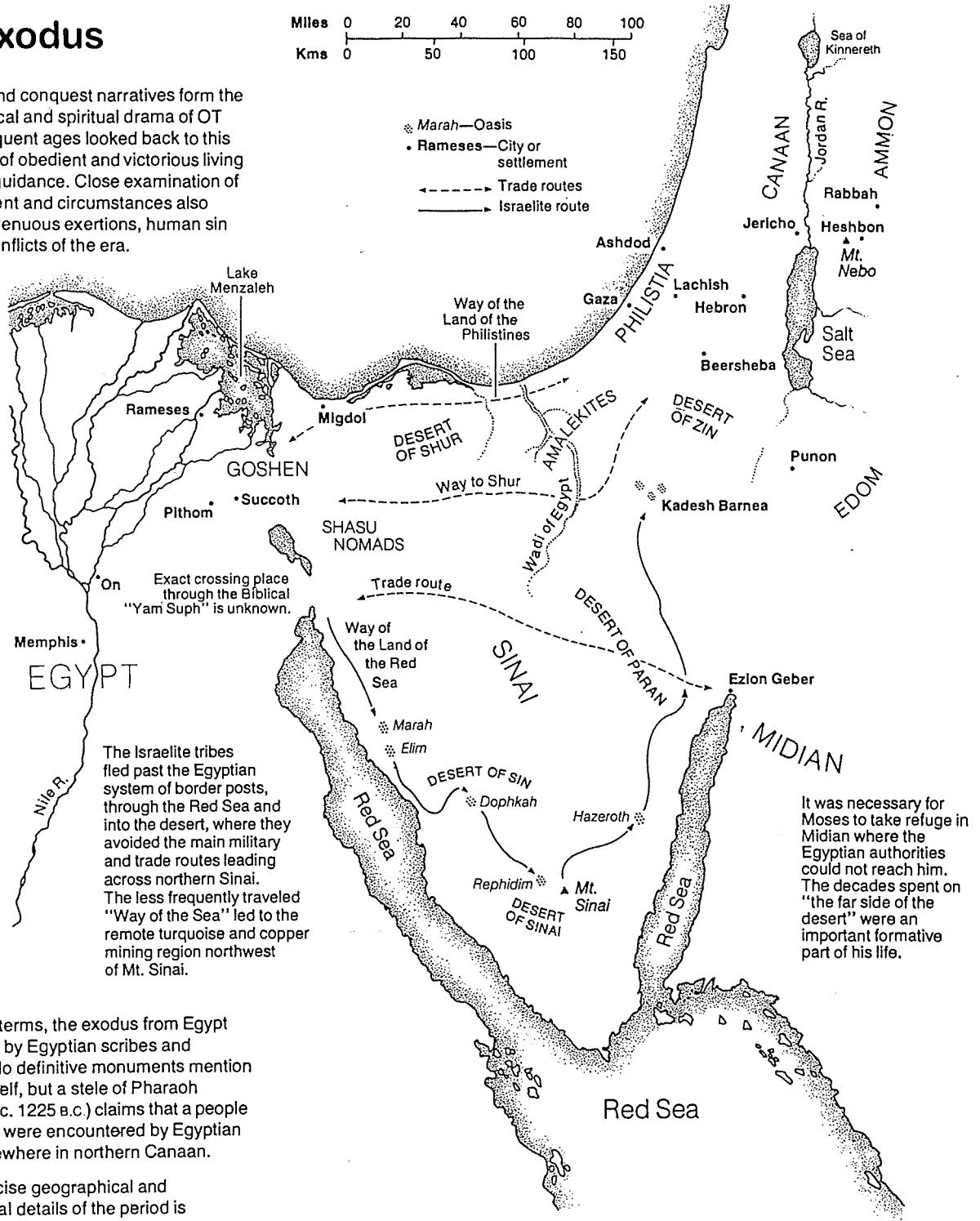

In historical terms, the exodus from Egypt was ignored by Egyptian scribes and recorders. No definitive monuments mention the event itself, but a stele of Pharaoh Merneptah (c. 1225 B.C.) claims that a people called Israel were encountered by Egyptian troops somewhere in northern Canaan.

Finding precise geographical and chronological details of the period is problematic, but new information has emerged from vast amounts of fragmentary archaeological and inscriptional evidence. Hittite cuneiform documents parallel the ancient covenant formula governing Israel's "national contract" with God at Mount Sinai.

The Late Bronze Age (c. 1550-1200 B.C.) was a time of major social migrations. Egyptian control over the Semites in the eastern Nile delta was harsh, with a system of brickmaking quotas imposed on the labor force, often the landless, low-class "Apiru." Numerous

Canaanite towns were violently destroyed. New populations, including the "Sea Peoples," made their presence felt in Anatolia, Egypt, Palestine, Transjordan, and elsewhere in the eastern Mediterranean.

Correspondence from Canaanite town rulers to the Egyptian court in the time of Akhenaten (c. 1375 B.C.) reveals a weak structure of alliances, with an intermittent Egyptian military presence and an ominous fear of people called "Habiru" ("Apiru").

Exodus 12:31—Deuteronomy 34:12  
 (Summary: Numbers 33:1-48)

# Egyptian Sojourn Chronologies Contrasted

Adapted (column 1 added) from John H. Walton, *Chronological and Background Charts of the OT*, 2d ed., 99 (cf. OTS, 108a-b)

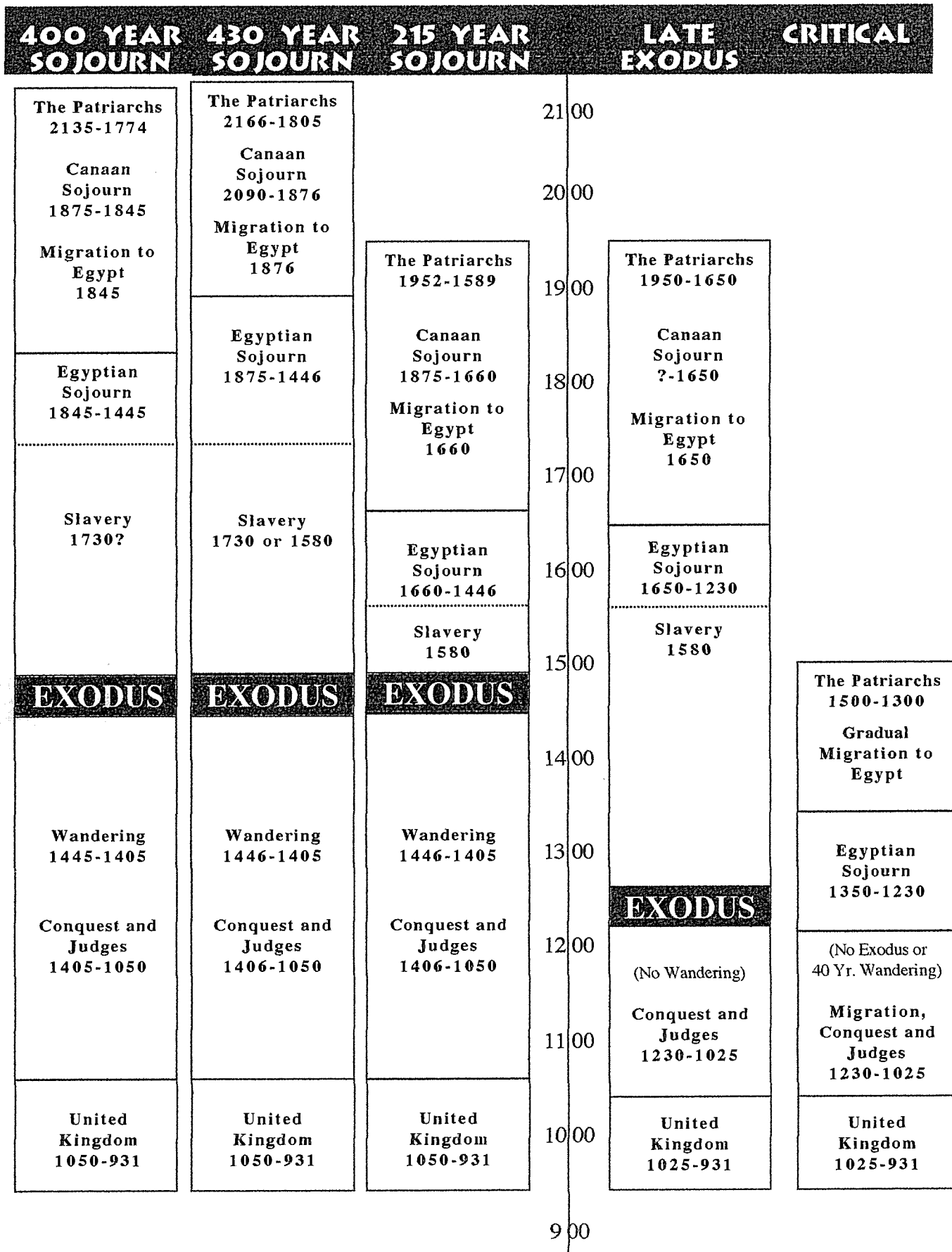



## Egyptian Sojourn Chronologies Evaluated

Correlate with my adaptation of John H. Walton, *Chronological and Background Charts of the OT*, 2d ed., 99 (cf. OTS, 108)

The following views are listed in order from the best to the worst perspective, in my opinion.

VIEW	400 YEAR SOJOURN	430 YEAR SOJOURN	215 YEAR SOJOURN	LATE EXODUS	CRITICAL
Exodus	Early	Early	Early	Late	Gradual Migration
Egyptian Sojourn	400	430	215	420	120
Years of Freedom	Unspecified	295 or 145	80	70	120
Years of Slavery	<400	135 or 285	135	350	none (a myth)
Exod. 12:40 Text	LXX & Samaritan Pentateuch	MT	LXX & Samaritan Pentateuch	MT	Unimportant
Exod. 12:40 Reading	"Now the length of time the Israelite people lived in Egypt and Canaan was 430 years"	"Now the length of time the Israelite people lived in Egypt was 430 years"	"Now the length of time the Israelite people lived in Egypt and Canaan was 430 years"	"Now the length of time the Israelite people lived in Egypt was 430 years"	Unimportant
Popularity	Few	Most common	Common	Few Evangelicals Many Liberals	Many Liberals
Support:	<ul style="list-style-type: none"> <li>• Gen. 15:13 (sojourn 400 yrs)</li> <li>• Acts 13:19-20 "about 450 years" = 400 + 40 + 7 = 447 yrs.</li> <li>• Exod. 12:40 "children of Israel" points to Gen. 35:10 (1875 BC) to begin 430 years since this is when nation called "Israel"</li> </ul>	<ul style="list-style-type: none"> <li>• Follows MT of Exod. 12:40</li> <li>• Scripture sometimes uses round numbers (See the next few pages for more early date arguments)</li> </ul>	<ul style="list-style-type: none"> <li>• Follows MT of Exod. 12:40</li> <li>• The new king of Exod. 1 was a native Egyptian who followed the Hyksos</li> <li>• Their later date for Abr. Cov. (1875 BC) to Jacob entering Egypt (1660 BC) is 215 yrs.</li> </ul>	<ul style="list-style-type: none"> <li>• Archaeology supports the destruction of some Canaanite cities in the 13th century (See the next few pages for more late date arguments)</li> </ul>	<ul style="list-style-type: none"> <li>• The city of Rameses (Exod. 1:11) must have been built after Rameses II (1300 BC) since it was named after him</li> </ul>

VIEW	400 YEAR SOJOURN	430 YEAR SOJOURN	215 YEAR SOJOURN	LATE EXODUS	CRITICAL
<b>Problems:</b>	<ul style="list-style-type: none"> <li>Gal. 3:17 notes Abr. Cov. as "established" (not "confirmed")</li> <li>Follows LXX of Exod. 12:40 (not normal practice to hold LXX over MT)</li> </ul>	<ul style="list-style-type: none"> <li>400 is not 430 rounded</li> <li>430 seen as yrs. of slavery, but Gal. 3:17 begins at Abr. Cov.</li> <li>Acts 13:19-20 "about 450 yrs" = 430 + 40 + 7 = 477 yrs. (not close enough)</li> </ul>	<ul style="list-style-type: none"> <li>A 215 year slavery conflicts with Gen. 15:13</li> <li>Hyksos rulers are not found in Exod. 1</li> <li>The Abr. Cov. was established in 2060 BC — not 1875 BC (cf. OTS, 87)</li> </ul>	<ul style="list-style-type: none"> <li>1 Kings 6:1 says the temple completion was 480 years after the Exodus</li> <li>Only Jericho, Ai, and Hazor were destroyed in the 15th century</li> <li>Archaeology better supports a 15th century destruction</li> </ul>	<ul style="list-style-type: none"> <li>Moses wasn't even born before Exod. 1:11 and yet was 80 years old at the Exodus</li> <li>The view denies that the Exodus ever occurred</li> <li>It ignores the numbers of Jud. 11:26; 1 Kings 6:1</li> </ul>
<b>Advocates:</b>	Hoehner <sup>1</sup> Rea <sup>2</sup> Griffith <sup>3</sup>	Benware <sup>4</sup> Whitcomb <sup>5</sup> Archer <sup>6</sup> Unger <sup>7</sup> Merrill <sup>8</sup>	Beitzel <sup>9</sup> Thiele <sup>10</sup> Anstey <sup>11</sup> English <sup>12</sup> Ozanne <sup>13</sup>	Albright <sup>14</sup> Kitchen <sup>15</sup>	Rowley <sup>16</sup> Bright <sup>17</sup>

<sup>1</sup> Harold W. Hoehner, "The Duration of the Egyptian Bondage," *Bibliotheca Sacra* 126 (October-December, 1969): 314.

<sup>2</sup> John Rea, "The Time of the Oppression and the Exodus," *Grace Journal* (Winter, 1961): 5, 80. He also notes that the oppression began just after 1730 BC (p. 8).

<sup>3</sup> See the study entitled "Chronology of the Patriarchs" on pages 85-89 of these notes (timeline on p. 90).

<sup>4</sup> Paul N. Benware, *Survey of the Old Testament*, rev. ed. (Chicago: Moody, 1993), 44.

<sup>5</sup> John C. Whitcomb, "Chart of Old Testament Patriarchs and Judges" 4th ed. Winona Lake, IN: BMH Books, 1968. (pp. 95-96 of these notes).

<sup>6</sup> Gleason L. Archer, Jr., *A Survey of Old Testament Introduction* (Chicago: Moody, 1974), 205, 211-12.

<sup>7</sup> Merrill F. Unger, *Archaeology and the Old Testament* (Grand Rapids: Zondervan, 1954), 106, 150.

<sup>8</sup> Eugene H. Merrill, *Kingdom of Priests* (Grand Rapids: Baker, 1987), 76.

<sup>9</sup> Barry J. Beitzel, *The Moody Bible Atlas of Bible Lands* (Chicago: Moody, 1985), 85.

<sup>10</sup> Edwin R. Thiele, *The Mysterious Numbers of the Hebrew Kings* (Chicago, 1951); S.v. "Chronology," *Zondervan Pictorial Encyclopedia of the Bible*, 1:166-67.

<sup>11</sup> Martin Anstey, *The Romance of Bible Chronology*, 2 vols. (New York: Marshall Brothers, 1913), 1:162.

<sup>12</sup> English, *New Scofield Reference Bible*, 86, n. 2.

<sup>13</sup> Ozanne, *The First 7000 Years*, 221-25.

<sup>14</sup> William Foxwell Albright, *From Stone Age to Christianity* (2d ed. with a new introduction; Doubleday Anchor Books; Garden City, NY: Doubleday & Co., 1957), 13, 223, 255-56.

<sup>15</sup> Kitchen ignores the explicit statement of the text by declaring that enough information about the chronology does not exist to verify the accuracy of 1 Kings 6:1 (Kitchen, *Ancient Orient and Old Testament* (Downers Grove: IVP, 1966), 72-75, 53-56). His assumption, of course, is that a biblical text without extra-biblical support is unreliable. See also s.v. "Chronology of the Old Testament" by K. A. Kitchen and T. C. Mitchell, 214-16, ed. J. D. Douglas, *The New Bible Dictionary*, Original © by Inter-Varsity Christian Fellowship, 1962; Reprint, Grand Rapids: Eerdmans, 1975.

<sup>16</sup> This kind of biblical inaccuracy is demonstrated by Rowley, who cites a seventy year bondage (c. 1300-1230 BC), followed by a two year wilderness wandering before entering Canaan. See Harold H. Rowley, *From Joseph to Joshua* (London: Published for the British Academy by the Oxford University Press, 1950), 164.

<sup>17</sup> John Bright, *A History of Israel* (Philadelphia: Westminster, 1959), 112-13.

# The Duration of The Egyptian Bondage = 400 years (1845 - 1445 B.C.)

Harold W. Hoehner

When one looks at the various passages of Scripture concerning the length of Israel's bondage in Egypt one immediately discovers that there are apparent disagreements in the biblical record. Various scholars have attempted to resolve the apparent discrepancies. The purpose of this article is to discuss and evaluate the various views and then attempt to present a solution to the problem.

## I. THE SCRIPTURES INVOLVED

Before discussing the various theories, a review of the Scripture passages concerning the duration of the bondage is in order. The passages are the author's own translation.

### PASSAGES MENTIONING 400 YEARS

*Genesis 15:13.* And he said to Abram: "Know with certainty that your descendents shall be strangers (sojourners) in a land that is not theirs and they shall serve them' and they shall oppress them for 400 years."

*Genesis 15:16.* And in the fourth generation they shall come back here again. . . .

*Acts 7:6.* And God spoke in this manner; that his [Abraham's] descendents shall be strangers in a land that is not theirs, and that they shall enslave them and maltreat (them) for 400 years.

### PASSAGES MENTIONING 430 YEARS

*Exodus 12:40-41.* Now the sojourning of the children of Israel, who dwelt in Egypt, was 430 years and it came to pass at the end of the 430 years, on that very day it came to

<sup>1</sup> The LXX adds here "and shall maltreat them." When this verse is quoted in Acts 7:6 this phrase is retained.

pass, all the hosts of the Lord went out from the land of Egypt.

*Galatians 3:17.* Now this I say: "The law which came 430 years afterward does not make void a covenant previously ratified by God' so as to invalidate the promise.

### PASSAGE MENTIONING 450 YEARS

*Acts 13:17-20.* The God of this people Israel chose our fathers, and exalted the people when they sojourned in Egypt and with a high arm he led them out of it, and for approximately forty years as a nursing father he bore' them in the wilderness. And when he destroyed seven nations in the land of Canaan he gave (them') their land as an inheritance for approximately 450 years. And after that' he gave them judges until Samuel the prophet.

## II. THE PROBLEM STATED

One sees immediately that there are three figures for the length of Israel's sojourn in Egypt. Was it 400, 430, or 450 years? Can these differences be resolved in a way which will satisfy the given data in all these passages?

<sup>1</sup> The Samaritan Pentateuch (hereafter designated as SP) as well as the Alexandrinus and Lagardiana codices of the LXX add "and their fathers." Since there is no other MS evidence for this additional reading, the Masoretic text (hereafter designated MT) should stand as is.

<sup>2</sup> The SP has: "in the land of Canaan and in the land of Egypt." The LXX has the same words but in inverted order. Again because of weak support, the MT should stand as is.

<sup>3</sup> Some MSS add the words "in Christ." Although the weightiest MSS omit the words, their inclusion or exclusion is of no significance for this study.

<sup>4</sup> The textual variant "cared for" has about equal weight as the reading used in the above translation. The same two variants are found in the LXX of Deut. 1:31, the passage to which Paul is alluding, but the MT has simply נָשָׂא which means "to bear."

<sup>5</sup> This word is inserted for clarity in English and is included in some MSS.

<sup>6</sup> The Textus Receptus which the AV follows has the phrase "and after that" preceding the words "approximately 450 years." This would mean that there was an approximate 450-year span between Joshua's conquering of the land and Samuel the prophet. Thus the period of the judges was about 450 years. The reading of the Nestle text is better because: (1) it is favored by the more weighty MSS (p7+ א B C 33 81 181 it-ar c vg arm geo), and (2) it fits better with I Kings 6:1 where there is a 480-year period from the Exodus to the fourth year of Solomon—otherwise if one accepts the Textus Receptus reading, one would have to squeeze into the 480-year period the 450 years of the judges period, the reigns of Joshua, Saul, David, and the first three or four years of Solomon's reign, and forty years of wilderness wanderings. Accepting the reading of the Nestle text, viz., the placing of the approximate 450 years from the commencement of the Egyptian bondage until Joshua's conquest of the land, will be discussed in the text below.

### Support for a 400-Year Egyptian Bondage

Harold W. Hoehner, "The Duration of the Egyptian Bondage," *Bibliotheca Sacra* 126 (October-December 1969): 315-16

This view is the one advocated on pages 85-90 of these notes.

### THE DURATION OF THE EGYPTIAN BONDAGE 315

whereas the AV translates it *who* which refers back to "the children of Israel." Since אִשְׂרָאֵל is indeclinable and its antecedent may be singular or plural and may be of either gender, it allows for great latitude in translation. However, here it seems best to have "the children of Israel" as its antecedent rather than the word "time." The reasons are twofold. Firstly, the phrase "the children of Israel" would be closer in position to אִשְׂרָאֵל. Secondly the noun מִשְׁכָּן which comes from שָׁכַן has the primary meaning *to sit, rest, dwell* and hence the noun is translated *dwelling-place, dwelling, dwellers, assembly, or seat.*" The ASV and RSV translation *time* is a derived and secondary meaning. In fact מִשְׁכָּן which occurs forty-four times in the Old Testament is never so rendered by the ASV and RSV translators in any other place except in Exodus 12:40. Even in Exodus 12:20 they translate it *habitations and dwellings* respectively. Thus the AV translation *sojourning* is an acceptable rendering. This would mean that the clause ("who dwelt in Egypt") would be nonrestrictive and only gives additional information concerning the sojourners." The commencement of their sojourning would have been the last confirmation of the Abrahamic covenant as given in Genesis 35:9-15, if one notices that from Genesis 35 onwards the children of Israel never remained in one place in Canaan but were always travelling (cf. Gen. 35:16, 21, 27; in 37:1 they dwelt in the land of Canaan with no specific location mentioned).

Thirdly, it is interesting to notice that whereas in Exodus 12:40 the MT has "now the sojourning of the children of Israel, who dwelt in Egypt, was 430 years. . . ." the SP and LXX has "now the sojourning of the children of Israel, who dwelt in the land of Canaan and in the land of Egypt (the LXX has it in inverted order), was 430 years. . . ." This indicates that the sojourning would include Canaan and Egypt. Although the present writer does not put much stock in the SP and the LXX as far as chronological matters, this inclusion may point back to some early tradition in the text. It is somewhat diffi-

cult to explain its inclusion except that there was some sort of early tradition for this reading.

Therefore, it seems that if one will take the 430 years as the period from the last recorded confirmation of the Abrahamic covenant to Israel (Jacob) before going into Egypt (Gen. 35:9-15) until the time of the Exodus, the 400 years would be that period of time when the nation Israel was in Egypt, that is, from the time when Jacob and his family entered Egypt (Gen. 46) until the Exodus. The phrase "about 450 years" (Acts 13:19-20) would consist of the 400 years of bondage plus the 40 years of wilderness wanderings plus the 7 years for conquering the land of Palestine which makes a total of 447 years or "about 450 years."

#### IV. THE CONCLUSION AND SUMMARY

After considering the two more well-known theories in the attempt to resolve the apparent discrepancies concerning the length of the Egyptian bondage, a third view was presented which takes into account and better explains all the biblical data. Assuming the 1445 B.C. date for the Exodus, it could be charted as follows:

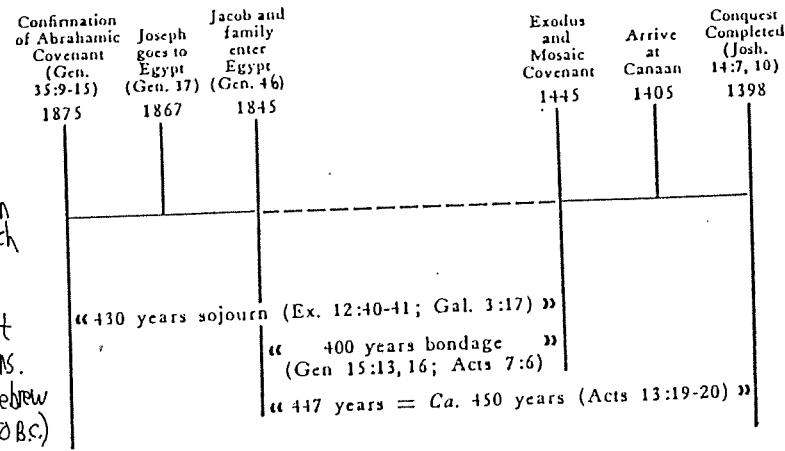

Samaitan Pentateuch

Septuagint (Greek Trans. of the Hebrew OT in 250 B.C.)

<sup>11</sup> Francis Brown, S. R. Driver, and Charles A. Briggs, *A Hebrew and English Lexicon of the Old Testament*, p. 444.

<sup>12</sup> Cf. Cooper, *op. cit.*, pp. 129-30. Notice in the first part of this article when translating Exodus 12:40-41, the clause "who dwelt in Egypt" is set off by commas. For clarity it could be rendered: "Now the sojourning of the children of Israel (who dwelt in Egypt) was 430 years. . . ."

## Date of the Exodus

John H. Walton, *Chronological and Background Charts of the OT*, 2d ed., 102-3 (1 of 2)

very weak arguments!  
↓

15th-CENTURY EVIDENCE	13th-CENTURY REBUTTAL
I Kings 6:1 designates 480 years from the Exodus to Solomon's dedication of the temple. The dedication was 966. That makes the Exodus 1446.	The 480 years is most likely 12 generations (12x40=480). In actuality, a generation was about 25 years, making the actual figure about 300.
The "Dream Stela" of Thutmose IV on the sphinx gives evidence that Thutmose was not legal heir to the throne. Would be logical that eldest son was killed in the 10th plague.	Only one of many other possibilities. No proof that the biblical plague was involved in the death of the rightful heir.
In Judges 11:26, Jephthah assigns 300 years between his day (c. 1100) and the Conquest. This would seem to indicate a 15th-century Exodus.	This was a generalization or a rough and slightly inaccurate guess by Jephthah who would have had no access to historical records.
To support the biblical chronology of Moses, Pharaoh must have reigned in excess of 40 years. Moses stayed in the wilderness until Pharaoh died. Only possibilities: Thutmose III, Rameses II.	Moses' 40 years with the Midianites is not really a chronological reference.
The Last Level at Hazor, wiped out by Barak and Deborah, contains Mycenaean IIIB Pottery; this requires, at the latest, a date in the late 13th century. This pushes Exodus much earlier.	The judges overlapped enough to accommodate this.
The Merneptah Stela (C. 1220) mentions Israel by name. They must have been there for a long time for the Egyptians to accept them as a nation.	Fifty years would have been sufficient time.
The Amarna Tablets (1400) tell of the upheaval caused by the "Habiru." This could have been the Hebrews, possibly classified under a general category.	The "Habiru" can in no way be identified with the Israelites.
The length of time assigned to the judges period in Scripture, even with overlapping, cannot be squeezed into the century and a half allowed by a 13th-century Exodus.	With overlaps and understanding of the symbolic nature of time spans, it can be fitted in.

**Date of the Exodus**

John H. Walton, *Chronological and Background Charts of the OT*, 2d ed., 102-3 (2 of 2)

↳ very weak arguments!

13th-CENTURY EVIDENCE	15th-CENTURY REBUTTAL
<p>The civilizations of Edom, Moab, and Ammon were not in existence in the 15th century. Since Israel had contact with them, the Exodus must be later.</p>	<p>Finds at the Timna temple indicate sedentary civilizations in Negev at least in early 14th century. Tribes were wandering earlier than that.</p>
<p>The destruction of Lachish, Debir, and Bethel were in the 13th century, as indicated by the layer of ash.</p>	<p>Lachish, Debir, and Bethel are not said to have been burned at the time of the Conquest. The layer of ash could be due to Egypt's conquests.</p>
<p>In Exodus 1:11, Israelites were said to have been building the city of Rameses. This must be in honor of Rameses II of 13th century.</p>	<p>(1) Name "Rameses" used much earlier than 13th century. (2) City was being built before birth of Moses; thus, before Rameses II, even with late Exodus. (3) This was a store city, not a capital.</p>
<p>The 430 years of Exodus 12:40 cannot fit in with the Hyksos period.</p>	<p>The Hebrews need not be related to the Hyksos. There is much evidence that Jacob went to Egypt almost 150 years before the Hyksos period began.</p>
<p>Thutmose III was not known as a great builder and therefore does not fit into the historical picture.</p>	<p>Though not known as a great builder, Thutmose III is known to have had some building projects in the delta region.</p>
<p>Scripture does not mention the Palestinian invasions of Seti I or Rameses II. Therefore, Exodus must have been in 13th century and Israel was not yet in Palestine.</p>	<p>It is very likely that the periods of "rest" during the Judges were the periods of tighter Egyptian control. The Egyptian invasions were against the Canaanites.</p>
<p>Pushing the Exodus back means pushing the patriarchs back, and the Patriarchs cannot go back any farther.</p>	<p>There is just as much evidence for putting the patriarchs in Middle Bronze I as there is for putting them in Middle Bronze II.</p>

# Hebrew Calendar and Selected Events

NUMBER of MONTH		HEBREW NAME	MODERN EQUIVALENT	BIBLICAL REFERENCES	AGRICULTURE	FEASTS
1	7 <small>Sacred sequence begins</small>	Abib; Nisan	MARCH—APRIL	Ex 12:2; 13:4; 23:15; 34:18; Dt 16:1; Ne 2:1; Est 3:7	Spring (later) rains; barley and flax harvest begins	Passover; Unleavened Bread; Firstfruits
2	8	Ziv (Iyyar)*	APRIL—MAY	1 Ki 6:1, 37	Barley harvest; dry season begins	
3	9	Sivan	MAY—JUNE	Est 8:9	Wheat harvest	Pentecost (Weeks)
4	10	(Tammuz)*	JUNE—JULY		Tending vines	
5	11	(Ab)*	JULY—AUGUST		Ripening of grapes, figs and olives	
6	12	Elul	AUGUST—SEPTEMBER	Ne 6:15	Processing grapes, figs and olives	
7	1 <small>Civil sequence</small>	Ethanim (Tishri)*	SEPTEMBER—OCTOBER	1 Ki 8:2	Autumn (early) rains begin; plowing	Trumpets; Atonement; Tabernacles (Booths)
8	2	Bul (Marcheshvan)*	OCTOBER—NOVEMBER	1 Ki 6:38	Sowing of wheat and barley	
9	3	Kislev	NOVEMBER—DECEMBER	Ne 1:1; Zec 7:1	Winter rains begin (snow in some areas)	Hanukkah ("Dedication")
10	4	Tebeth	DECEMBER—JANUARY	Est 2:16		
11	5	Shebat	JANUARY—FEBRUARY	Zec 1:7		
12	6	Adar	FEBRUARY—MARCH	Ezr 6:15; Est 3:7, 13; 8:12; 9:1, 15, 17, 19, 21	Almond trees bloom; citrus fruit harvest	Purim

(Adar Sheni)\*  
Second Adar

This intercalary month was added about every three years so the lunar calendar would correspond to the solar year.

\* Names in parentheses are not in the Bible

© 1989 by Gospel Light Publications. Permission granted to purchaser to reproduce this Sheet for class purposes only.

Hebrew Calendar and Selected Events  
 The Bible Visual Resource Book, 21; NIV Study Bible note on Exodus 12:2 (lower right)

Dr. Rick Griffith

Old Testament Survey: Exodus

12:2 *This month is ... the first month.* The inauguration of the religious calendar in Israel (see chart on "Hebrew Calendar," p. 101). In the ancient Near East, new year festivals normally coincided with the new season of life in nature. The designation of this month as Israel's religious New Year reminded Israel that her life as the people of God was grounded in God's redemptive act in the exodus. The Canaanite name for this month was Abib (see 13:4; 23:15; 34:18; Dt 16:1), which means "young head of grain." Later the Babylonian name Nisan was used (see Ne 2:1; Est 3:7). Israel's agricultural calendar began in the fall (see note on 23:16), and during the monarchy it dominated the nation's civil calendar. Both calendars (civil and religious) existed side by side until after the exile. Judaism today uses only the calendar that begins in the fall.

## The Location of Mount Sinai

Where is Mount Sinai? Interpreters have differed on this question through the centuries, but two major locations are discussed in this study—in the southern Sinai and in northwestern Saudi Arabia.<sup>1</sup>

### I. Southern Sinai Peninsula (Traditional View)

#### A. Support

##### 1. Historical

- a) Nearly all Bible atlases place Mt. Sinai at the traditional location known as Jebel al-Musa ("Mountain of Moses") in the southern Sinai Peninsula.<sup>2</sup>
- b) This site has been known since the fourth century AD by Saint Helena, the Emperor Constantine's mother, who built a chapel and tower at the foot of the altar to commemorate the place. Later St. Catherine's monastery was built to identify it in an even more permanent manner. Thus "the major strand of Christian tradition has been woven around J. Musa..."<sup>3</sup>

##### 2. Biblical

- a) Assuming that the Egyptians chased the Israelites the next morning after the exodus, there would not have been enough time for Israel to cross the entire Sinai Peninsula within a day (Exod. 13:17-22). The alternate view must assume they traveled this far in a day unless more time is allowed to travel farther across the Sinai to be poised for entrance into Arabia by crossing the Gulf of Aqaba.
- b) Biblical atlases note that the Desert of Sin lies in the southern portion of the Sinai Peninsula on the way to Mount Sinai (Exod. 16:1).

#### B. Problems

1. No archaeologists have found the ancient sites that Israel visited between Egypt and the southern Sinai (e.g., the bitter springs of Marah, the springs at Elim).
2. Egyptians could have easily gone around the Great Bitter Lake or Small Bitter Lake if Israel was hemmed between them and the sea.
3. Exodus 12 does not specifically say that Pharaoh chased Israel the day after the Exodus. Perhaps this occurred days later after his grieving for his own son and the other dead firstborn sons of Egypt. If this is true, enough time could have elapsed for the people to reach the Gulf of Aqaba.

---

<sup>1</sup> Barry J. Beitzel, *Moody Atlas of Bible Lands* (Chicago: Moody, 1985), 90-93 has an extensive treatment of the issue, including interaction with a third location in the northern Sinai. He holds to the southern Sinai view. It would not have taken Elijah 40 days to travel from Beersheba to a northern location (1 Kings 19:8) but the 250 miles to southern Sinai fits well. Also, other texts indicate a large distance from Kadesh Barnea to Sinai (Num. 33:16-36; Deut. 1:2).

<sup>2</sup> Atlases arguing for the traditional site include R. K. Harrison, "The Exodus and Conquest of Canaan," in *The Zondervan Pictorial Bible Atlas*, E. M. Blaiklock, ed. (Grand Rapids: Zondervan, 1969, 1972), 65; Joseph L. Gardner, ed., *Reader's Digest Atlas of the Bible* (Pleasantville, NY: Reader's Digest, 1987), 66-68; Beitzel, 92.

<sup>3</sup> Beitzel, 92.



## II. Saudi Arabia (Alternate View)

### A. Support

#### 1. Scripture

- a) Paul locates the mountain in his mention of "Mount Sinai in Arabia" (Gal. 4:25). Jebel al-Lawz is the tallest peak in Arabia and thus the likely spot, though others have been proposed.
- b) The path from Mt. Sinai to Kadesh Barnea follows the Mount Seir road (Deut. 1:2). Given the eastern location of Mount Seir, if the road was on the eastern side of the Jordan rift, then it would lead south into Arabia rather than into the Sinai.
- c) That the Israelites "fled" rather than simply "left" (Exod. 5:14) may indicate that their initial permission was only to worship the Lord for three days. Their fleeing may indicate that they continued on past what Pharaoh had granted.

#### 2. Logic

- a) It seems likely that Moses brought the Israelites back to the area of Midian where he had lived for 40 years. Midian lies on the eastern side of the Gulf of Aqaba.<sup>4</sup> Since Moses lived in Midian (Exod. 2:15) and the burning bush incident took place on Mount Sinai (Exod. 3:1), then Mount Sinai must have been in Midian since the text does not say that he left Midian to go to Mount Sinai. (The assumption is that the "far side of the desert" is still in Midian unless the text says it is not.)
- b) The Saudi government has outlawed visits to this alternate site known as Jebel al-Lawz. They also outlaw visits to the Caves of Moses en route to Jebel al-Lawz.
- c) Mount Sinai had much volcanic or earthquake activity (Exod. 19:18; 24:17; etc.), and Saudi Arabia has more volcanic activity than the Sinai. This was noted as far back as the third century BC by the Jewish historian Demetrius, who lived in Egypt.<sup>5</sup>

#### 3. Archaeology<sup>6</sup>

- a) A submerged land bridge extends from the SE Sinai to the Arabian side. By miraculously pushing away the water on either side, it would have allowed the Israelites

---

<sup>4</sup> Harvard professor Frank Moore Cross does not specifically identify Jebel al-Lawz as the Mount Sinai site but he does note that Midian is the land of Mount Sinai and that Midian is in northwestern Saudi Arabia (*BAR* July/August 1999, p. 54).

<sup>5</sup> See Roland de Vaux, *Ancient Israel: Its Life and Institutions*, translated by John McHugh (New York: McGraw-Hill, 1961), 435; cited by Beitzel, 90, n. 19.

<sup>6</sup> Most of these archaeological arguments come from a 1988 visit to Saudi Arabia chronicled in Bob Carnuke and Larry Williams, "The Search for the Real Mount Sinai," 46 minute video tape (Monument, CO: Reel Productions, 1998 and P.O. Box 1798, Colorado Springs, CO 80901-1798: Biblical Archaeology, Search and Exploration Institute, 1998; Tel. 1-800-680-3300), \$24.95). See also Larry Williams, *The Mountain of Moses* (140 Marine View, Office 204, Solana Beach, CA 92075: CTI Publishing, 1999; Tel. 1-800-748-5843) or Larry Williams, *The Mountain of Moses: The Discovery of Mount Sinai* (Wynwood Press, New York, 1990); Howard Blum, *The Gold of Exodus: The Discovery of the True Mount Sinai* (NY: Simon & Shuster, 1998), \$25.00 hb, 364 pp.; Ron Wyatt also has a sensationalistic video ("Presentation of Discoveries" \$30.00) as well as a web page (including many pictures) claiming a Saudi location (<http://www.ronwyatt.org/exodus/index.html>); Even Hershel Shanks, editor of *Biblical Archaeology Review*, says, "...all identifications of Mount Sinai are highly speculative. A good case has been made that it is somewhere in northwest Saudi Arabia, and Jebel al-Lawz is the highest point in this area" (*BAR*, Nov/Dec '99, p. 67). Brad Sparks documents the many errors in Williams' book at <http://www.ldolphin.org/sinai.html>.

to travel across the sea with no need to descend hundreds of feet downward to the bottom of the sea. Such a steep climb would have made it nearly impossible to climb up the other (eastern) side with their carts, women, children, and animals.

- b) There are bitter springs 33 kilometers from the crossing point (a three day journey) which are where one would expect the bitter springs of Marah (Exod. 15:22-26).
- c) Other springs follow on the route to Jebel al-Lawz which could be the 12 springs and 70 palms of Elim (Exod. 15:27). At this location are the "Caves of Moses." Bedouin attribute the petroglyphs (rock carvings) within the caves to Moses and their tradition identifies this site as the home of Jethro.
- d) The mountain of Jebel al-Lawz shows evidence of a major encampment.
  - (1) The Split Rock of Horeb is nearby. It is a large rock 47 feet tall with a 19 inch crack down the middle that has evidence of a large flow of water over the granite stone that empties into a lake area large enough to enable the two million Israelites to drink for a year (Exod. 17:1-7).
  - (2) The area of the mountain has two evidences of burning on it.
    - (a) The entire top of Jebel al-Lawz is blackened (Exod. 19:18).
    - (b) One small burn mark is close by which is potentially where God appeared next to the Split Rock of Horeb. It has melted stone!
  - (3) A two mile semicircle of boundary stones encircle the mountain at 400 foot intervals (Exod. 19:12).
  - (4) The mountain has a cave which could be the one Elijah visited (1 Kings 19:8-9). No such cave has ever been found on Jebel al-Musa.
  - (5) The base of the mountain has a 60 x 60 foot altar of uncut stone with ashes.
  - (6) Another altar with petroglyphs lays in front of the mountain with huge cut stones rising 30 feet, which is like one would expect at the golden calf incident (Exod. 32). This is unlike any altar in the area, especially since the animals depicted are Egyptian cows.
  - (7) An area near Mount Sinai is large enough for the battle between Israel and the Amalekites at Rephidim (Exod. 17:8-16).

## B. Problems

### 1. Scripture

- a) The reference to "Mount Sinai in Arabia" in Galatians 4:25 is unconvincing. It must first be established that "Arabia" in Paul's day referred *only* to the *east* side of the Gulf of Aqaba.

- (1) In Paul's time, "Arabia" covered a wide area that "included the Sinai Peninsula" as well as what we now call Saudi Arabia, according to Cambridge scholar Graham Davies.<sup>7</sup>
- (2) Midian and Mount Sinai were in separate places since Moses sent his Midianite father-in-law "back to his own country," referring to Midian (Exod. 18:27; cf. Num. 10:29-31).
  - b) The Mount Seir road may derive its name only from the road *ending* up at Mount Seir rather than the entire road extending only on the eastern Jordan Rift. It may have extended into the Sinai Peninsula as well.
  - c) The "fleeing" of the Israelites (Exod. 5:14) more naturally refers to their initial flight from Egypt rather than to a hastened pace after the third day. While earlier in the account they requested a three-day trip from Pharaoh, it is an argument from silence to say the king granted them only a three-day journey after the tenth plague.

## 2. Logic

- a) While Moses did live in Midian 40 years, Mount Sinai was on the "far side of the desert" (Exod. 3:1). Let's assume that the Midianites lived on the east side of the Gulf of Aqaba. If so, the natural reading of the "far side of the desert" would be the opposite side of the Gulf of Aqaba, or the western side (southern Sinai Peninsula), especially since Jethro's traditional home and Jebel al-Lawz would be in close proximity. Also, Midianites were a nomadic people who resided in many places: Moab (Gen. 36:35; 1 Chron. 1:46), the Mishor region of the Transjordan (Num. 25:6-7; Josh. 23:21), the wilderness east of Moab and Ammon (Jud. 7:25; 8:18-19), the northern Sinai (1 Kings 11:18), and even within Canaan itself (Jud. 6:1-6; 7:1). Thus, the location of Midian cannot help to determine the location of Mount Sinai with any certainty.
- b) The prohibitions of the Saudi government from people visiting Jebel al-Lawz could be due to their military establishment there as much as preventing archaeological exploration. Numerous sites in Saudi Arabia are off-limits to visitors, so Jebel al-Lawz is not at all unusual.
- c) The higher volcanic activity of the Saudi Peninsula over the Sinai Peninsula is not convincing in the case of the Exodus generation. The Bible does not speak in terms of general characteristics of the land but rather of a single instance. Besides, the Sinai Peninsula experienced a quake exceeding 6.0 on the Richter scale in 1982 that was centered in Nuweiba though felt on J. Musa.<sup>8</sup>

---

<sup>7</sup> Brad Sparks provides a convincing case against a Saudi location (<http://www.ldolphin.org/sinai.html>). Sparks cites evidence for "Arabia" including the Sinai Peninsula on his note 27 quoting Graham I. Davies, *The Way of the Wilderness* (Cambridge Univ. Press, London, 1979): "Davies, *Wilderness* (1979) pp. 30, 99 n. 1, emphasis added. In Herodotus ca. 450 BC, not only was the Sinai Peninsula considered PART OF ARABIA but, surprisingly, so was all of the eastern desert half of what WE now call EGYPT on the continent of AFRICA. In Greek and Roman Empire days, the bulk of the Sinai Peninsula was left to the Nabateans as "Arabia Petrea," until their conquest by the Romans in 106 AD The southern and central Sinai were then merged into the new Province of Arabia. Even in modern times, Wilhelm Gesenius listed both MT. SINAI and the Sinai Peninsula as PART OF "ARABIA," in his famous 1834 Hebrew Lexicon. (Herodotus II:8, 11, 158; Michael Avi-Yonah, "Sinai," *Encycl. Judaica*, vol. 14, p. 1595; Eckenstein, *Hist. Sinai*, p. 91; Davies, *Wilderness*, p. 30; Avraham Negev (ed.), *The Archaeological Encyclopedia of the Holy Land [AEHL]* (Thomas Nelson, Nashville, Tenn., 1986 rev.) pp. 65, 221-223, 276, 292, 351; Samuel P. Tregelles (trans.), *Gesenius...Hebrew and Chaldee Lexicon* (Baker, Grand Rapids, Mich., 1979 reprint [London, 1847, 1857]) p. 584 (Strong's no. 5514)."

<sup>8</sup> Noted by Beitzel, 91. This is not as convincing as it may sound, however, since Nuweiba lies on the Gulf of Aqaba closer to J. Lawz than to J. Musa.

### 3. Archaeology

- a) Since no one knows where Israel actually crossed the *Yam Suf* (Red Sea or Sea of Reeds), no one also knows that a submerged land bridge would be necessary as the depth of the sea would also be unknown. Since God could miraculously part the waters, we should assume that He could also help them across—no matter the incline!
- b) It is unlikely that Israel crossed the salt-water Gulf of Aqaba since *Yam Suf* can mean Sea of Reeds and reeds grow only in fresh water.
- c) Signs of an encampment need not refer only to the encampment by Israel.
  - (1) The water from the rock incident was at the town of Rephidim (Exod. 17) rather than in front of Mount Horeb. Also, one need not find the water source since this was a miraculous yet probably temporary water supply that was only for Israel. The rock need not be an imposing stone either.
  - (2) The blackened top of Jebel al-Lawz is due to manganese rock. Actually, many mountains in this region are dark for this reason. Besides, Scripture does not say that God blackened Mount Sinai. Also, the claim to have melted stone does not sound convincing. Jebel al-Lawz is in a volcanic zone, so melted stone here is not unusual.
  - (3) One must prove that rock piles at 400-foot intervals are indeed boundary stones before claiming that they are such markers.
  - (4) The lack of a cave at Jebel al-Musa now does not mean it did not have a cave during Elijah's time. An earthquake or shifting rocks could easily cover it after nearly 30 centuries.
  - (5) The altar at the base of Jebel al-Lawz is not of Israelite origin. God told Moses to make an altar of earth—not stone—on Mount Sinai (Exod. 20:24; 24:4), for burnt offerings and fellowship offerings.
  - (6) The discovery of petroglyphs (rock carvings) at Jebel al-Lawz only proves that someone wrote there—not that it was Moses.<sup>9</sup> The surrounding area is filled with numerous rock carvings over the ages. (And does an Egyptian cow drawing look significantly different from a non-Egyptian one?)
  - (7) Existence of an area large enough to fight the Amalekites does not prove that such a battle took place near Jebel al-Lawz. The area near Jebel al-Musa also has areas large enough for battles.

4. Perhaps the clearest argument favoring the traditional view is that the Desert of Sin (which included Mount Sinai) is located on all Bible atlases in the southern Sinai Peninsula. Since this desert is not in Arabia, the Mount Sinai within the desert would not be in Arabia either (cf. Gal. 4:25).

---

<sup>9</sup> See Ronald S. Hendel's review of Blum's book noted above and particularly of the video by Carnuke and Williams (*BAR* July/August 1999, p. 56).

### Conclusion

The debate continues whether Mount Sinai is located in the traditional location in the southern Sinai Peninsula (Jebel al-Musa) or east of this in northwestern Saudi Arabia (Jebel al-Lawz). While both views have supporting arguments and problems, the alternate view deserves a closer look. At present I have no explanation for the two springs in Saudi Arabia which lend support to the eastern view. At least tentative support from Frank Moore Cross and Hershel Shanks also adds support to the view.

On the other hand, until the Desert of Sin can be proven to be in [Saudi] Arabia, the traditional view should not be abandoned. The location of the Desert of Sin has been a long-standing problem that seemingly will not be answered decisively until more evidence is forthcoming.<sup>10</sup>

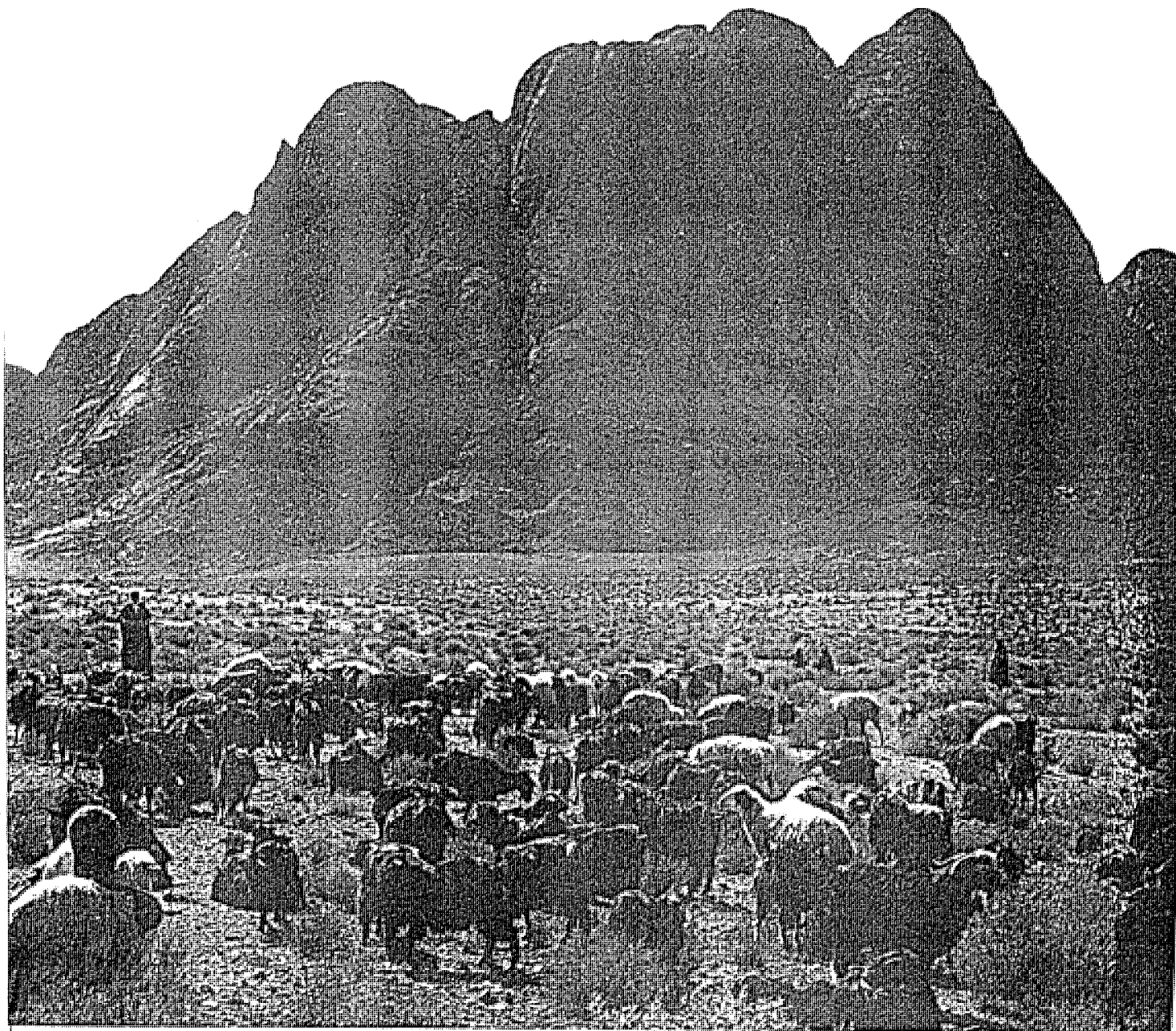

When Moses worked for Jethro, he tended sheep in the plains still used for pastureland near the traditional Mount Sinai (above).

---

<sup>10</sup> For further support of the traditional view, see Gordon Franz's newsletter for members of Associates for Biblical Research entitled "The Bible and Spade" (<http://www.ChristianAnswers.net/abr/abrhome.html>).

## Interpreting and Preaching Legal Literature

### A. A quick quiz to get you thinking...

1. T or F Christians should keep parts of the OT law which are not repeated in the NT.
2. T or F There are actually two laws: the moral (Ten Commandments) and ceremonial/civil.
3. T or F The Sabbath should still be obeyed by Christians.
4. T or F Believers today are obligated to keep all of the Ten Commandments.
5. T or F Tithing should be practiced by all followers of Christ.
6. T or F Christians today are prohibited from eating blood (e.g., yong tau foo, blood pudding, pig or duck blood at Chinese New Year).
7. T or F Believers must not charge other Christians interest based upon the Law (Deut. 23:19; Exod. 22:25; Lev. 25:36-37; Ezek. 18:8, 13, 17; 22:12; Prov. 15:5; 28:8).

### B. Defining the Meaning of Law (adapted from Fee/Stuart, 135-36)

1. Sometimes “Law” refers to the Pentateuch as a *single* book (e.g., Josh. 1:8).
2. Sometimes Christians refer to the “Law” as the *five* books of the Pentateuch, even though Genesis has no legal codes.
3. NT usage of the term “Law” sometimes refers to the Pentateuch and sometimes the entire OT (e.g., Luke 16:17).
4. Oftentimes “Law” refers to only the legal formation from Exodus 20–Deuteronomy 33. (It always refers to *at least* this portion of Scripture.)

### C. The Christian’s Relationship to the Law (adapted from Fee/Stuart, 136-39; these issues are addressed in detail in my ThD dissertation in the SBC library under Richard James Griffith, “The Eschatological Significance of the Sabbath,” Dallas Seminary, 1990, esp. pp. 144-56).

1. The OT law is a covenant between *Israel* and God—not between the *church* and God. The church and Israel must be kept distinct.
2. Our loyalty to God is shown in different ways than was Israel’s. In other words, God expected Israel to be loyal and He expects the same of us, but Israel’s loyalty was shown through observing the sacrificial system whereas our loyalty is shown by our obeying NT commands. (However, *faith* is what pleased God then and now—Heb. 11:6.)
3. Most OT stipulations are *not* repeated in the NT—especially the civil (penalties for crimes) and ritual (worship, especially sacrificial regulations) laws. Therefore, most of the OT does not directly apply to believers.
4. Some OT stipulations *are* repeated in the NT—including nine of the Ten Commandments, the exception being the Sabbath.
5. All of the OT law is still the *Word* of God for us even though it is not still the *command* of God for us. As such it is still useful for teaching and preaching, though applications must be made based upon the principles under girding the laws.
6. Only that which the NT explicitly *renews* from the OT law can be considered part of the NT “law of Christ” (Gal. 6:2). [Note: Fee/Stuart put *all* of the Ten Commandments in this category, which makes modern believers guilty of Sabbath breaking. I disagree that the Sabbath is binding in the present age. I worship corporately on Sunday, not Saturday!]

D. The Purposes of the Law (adapted from J. Dwight Pentecost, *BibSac* 128 [July 1971]: 227-33)

Paul's letter to the Galatians teaches sanctification not by the Law but by faith in Christ alone. This finds support in that Abraham was justified by faith centuries before the Law even came (Gal. 3:17). After that, the Law and the Promise (Gen. 12:1-3) co-existed for years, so there is no basic conflict between the Law and the Promise. This led Paul to ask, "What, then, was the purpose of the law?" (v. 19). Actually, there were at least ten purposes for the Law:

1. It revealed or exposed the *sinfulness of man* (Gal. 3:19).
2. It revealed the *holiness of God* (1 Pet. 1:15).
3. It revealed the standard of *holiness for people* in fellowship with God (Ps. 24:3-5).
4. It *supervised* the physical, mental, and spiritual development of the redeemed Israelite until he could come to maturity in Christ (Gal. 3:24).
5. It *unified* the people to establish the nation in voluntary submission to God's decrees (Exod. 19:5-8; Deut. 5:27-28).
6. It *separated* Israel among the nations as a kingdom of priests to mediate God's truth to these nations (Exod. 31:13).
7. It provided *forgiveness* of sins for individual Israelites to restore their fellowship with God, even though they already functioned as a redeemed people (Lev. 1-7).
8. It made provision for Israel to *worship* God as a redeemed people (Lev. 23).
9. It *tested* if one was in the kingdom or the theocracy over which God ruled (Deut. 28). Faith led to obedience and blessing; lack of faith led to disobedience and judgment.
10. It *revealed Jesus Christ* (typology in the sacrificial system; Luke 24:27).

Pentecost suggests that the *revelatory* aspect of the Law is permanent as it still reveals the holiness of God today (1 Tim. 1:8), but the *regulatory* aspect is temporary as it regulated the life and worship of the Israelite (Gal. 4:8-10; Col. 2:16-17). However, this view does not seem correct as the entire law has been abolished (see the next two pages, i.e., pp. 114-115). I feel that a better approach is the one below...

E. A Suggested Strategy for Expounding Old Testament Law

1. Interpretation: Study the *intent behind* the legal command, asking the question, "Why was this command given in Israel?" It is especially helpful to answer this question by showing how the law reveals the character of God. For example:

*"God told Israel in Leviticus 19:9-10 not to harvest the corners of the fields because He had compassion on the poor who could glean there for their food."*

2. Principlizing: State the intent of the law in the form of a *general principle*.

*"God wants His people to give the underprivileged the chance to earn a living."*

3. Application: Show how this principle relates to a contemporary parallel situation.

*"As an employer you should provide opportunities for the poor to support themselves."*

*By the way, you may be able to tell by now that I believe the answer to each question on the previous page's quiz is false.*

10 GREAT COMMANDMENTS

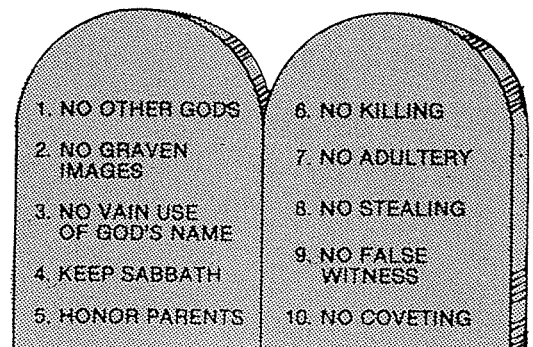



## The Ten Commandments

#	Old Testament Commands	New Testament Repetitions
1	And God spoke all these words: "I am the LORD your God, who brought you out of Egypt, out of the land of slavery. You shall have no other gods before me" (Exod. 20:1-3).	"Men, why are you doing this? We too are only men, human like you. We are bringing you good news, telling you to turn from these worthless things to the living God..." (Acts 14:15; mentioned at least 50 times).
2	"You shall not make for yourself an idol in the form of anything in heaven above or on the earth beneath or in the waters below... for I... am a jealous God, punishing the children for the sin of the fathers to the third and fourth generation ... but showing love to a thousand generations of those who love me..." (Exod. 20:4-6).	"Dear children, keep yourselves from idols" (1 John 5:21; cf. 1 Thess. 1:9; Rev. 2:14, 20; 9:20; mentioned in the NT 12 times = 12x).  * This chart is adapted and expanded from one by Lewis Sperry Chafer, <i>Systematic Theology</i> , 4:209-10
3	"You shall not misuse the name of the LORD your God, for the LORD will not hold anyone guiltless who misuses his name" (Exod. 20:7).	"Above all... do not swear—not by heaven or by earth or by anything else. Let your 'Yes' be yes, and your 'No,' no, or you will be condemned" (James 5:12; 4x).
4	"Remember the Sabbath day by keeping it holy. Six days you shall labor and do all your work, but the seventh day is a Sabbath to the LORD your God. On it you shall not do any work, neither you, nor your son or daughter, nor your manservant or maidservant, nor your animals, nor the alien within your gates. For in six days the LORD made the heavens and the earth... but he rested on the seventh day. Therefore the LORD blessed the Sabbath day and made it holy" (Exod. 20:8-11).	No NT text requires this of Christians.  However, one passage clearly <i>prohibits</i> the practice as required for believers: "Therefore do not let anyone judge you by what you eat or drink, or with regard to a religious festival, a New Moon celebration or a Sabbath day. These are a shadow of the things that were to come; the reality, however, is found in Christ" (Col. 2:16-17; 0x).
5	"Honor your father and your mother, so that you may live long in the land the LORD your God is giving you" (Exod. 20:12).	"Children, obey your parents in the Lord, for this is right. 'Honor your father and mother'—which is the first commandment with a promise—that it may go well with you and that you may enjoy long life on the earth" (Eph. 6:1-3; cf. Matt. 15:4-6; 19:19; Mark 7:10; 10:19; 6x).
6	"You shall not murder" (Exod. 20:13).	"Anyone who hates his brother is a murderer, and you know that no murderer has eternal life in him" (1 John 3:15; cf. Matt. 19:18; Mark 10:19; Luke 18:20; Rom. 13:9; James 2:11; 6x).
7	"You shall not commit adultery" (Exod. 20:14).	"Marriage should be honored by all, and the marriage bed kept pure, for God will judge the adulterer and all the sexually immoral" (Heb. 13:4; cf. Mark 10:19; 12x).
8	"You shall not steal" (Exod. 20:15).	"He who has been stealing must steal no longer, but must work, doing something useful with his own hands..." (Eph. 4:28; cf. Matt. 27:64; Mark 10:19; Luke 18:20; Rom. 13:9; Titus 2:10; 6x).
9	"You shall not give false testimony against your neighbor" (Exod. 20:16).	"Do not lie to each other, since you have taken off your old self with its practices" (Col. 3:9; cf. Eph. 4:25; 4x).
10	"You shall not covet your neighbor's house... wife, or his manservant or maidservant, his ox or donkey, or anything that belongs to your neighbor" (Exod. 20:17).	"Then he said to them, 'Watch out! Be on your guard against all kinds of greed; a man's life does not consist in the abundance of his possessions'" (Luke 12:15; Rom. 7:7; 13:9; Eph. 5:3; James 4:2; 2 Pet. 2:3, 14; 9x).



# Does the Law of Moses Apply to Me?

Summarizing the Five Main Views on the Law and the Christian\*

Should you as a Christian tithe? work on Saturday? charge interest to Jews? eat meat and drink milk in the same meal? The Pentateuch addresses these, but believers today debate whether the law applies to believers today. This chart summarizes five views on this crucial issue.

	<b>Theonomic</b> Greg Bahnsen	<b>Reformed</b> Willem VanGemen	<b>Weightier Issues</b> Walter C. Kaiser	<b>Modified Lutheran</b> Douglas J. Moo	<b>Dispensational</b> Wayne G. Strickland
What is the Law?	Same definition as the views 3-5	God's oral or written instructions since creation	The whole Mosaic law given in the Pentateuch (Genesis to Deuteronomy) but also amplified in the rest of the Old Testament		
Who is the Law for?	The Elect (Israel = Church)	All mankind (Israel = Church)	Believers (Israel and Church)	Believers (Israel and Church)	Israel only (Israel ≠ Church)
Which parts of the Law apply today?  • "Moral law" (i.e., Decalogue or 10 Commandments)	All moral laws apply to people of God only in every age; therefore, all elect persons since creation should observe either the Jewish Sabbath (Saturday, before Christ) or "Christian Sabbath," (Sunday, after Christ)	All moral laws apply to believers and unbelievers of every age (e.g., all persons—including unbelieving Gentiles since creation—should observe the Sabbath or "Christian Sabbath," being Sunday)	All moral laws that stem from God's character: • 10 Commandments • Leviticus 18-19 (sex) (i.e., Sabbath is required since Israel's nationhood and prohibited sexual practices still apply)	As with dispensationalists, the Mosaic law is abolished in its entirety; however, its moral content provides good guidelines for Christian living, though Christ holds the final say through the ministry of the Holy Spirit in believers today; Sabbath obedience is not consistently applied (?)	God's "moral law" before Moses is now called the "law of Christ" (Gal. 6:2) and governs believers through the Spirit's new covenant indwelling; The Law does not easily divide into "parts" and is done away with in its entirety (Rom. 7:1-6; 1 Cor. 9:19-21; Heb. 8:13), including the Sabbath (Col. 2:16-17)
• Civil laws? (i.e., judicial law)	All apply (e.g., laws today should require death for adultery)	Some apply (e.g., still tithe and don't charge believers interest)	Judicial <i>principles</i> (not laws) apply since moral laws underlie all judicial and ceremonial laws	Only principles apply now as the Mosaic law was given only to Israel	None apply as these regulated Israel alone (but principles such as love and compassion still apply)
• Ceremonial laws?	All five views agree that ceremonial aspects such as the sacrificial system and Jewish priesthood are now fulfilled in Jesus Christ				
What is the relationship of the Abrahamic Covenant to Mosaic Covenant?	Both are God's "covenant of grace." They consist of the same substance of God's saving relationship which makes the MC still apply today	MC was added to the AC; both still apply though they are similar in substance but different in form and purpose	MC was given specifically to Israel but its moral principles are still relevant to all believers under the AC	Like dispensationalists, MC was conditional but AC was not; MC as a temporary framework prescribed terms of obedience for Israel in Law period	MC regulated Israel's life so she could experience the blessings of the AC, but MC is no longer operative as it is fulfilled in Christ

\* This chart summarizes Stanley N. Gundry, ed. *Five Views on Law and Gospel* (Grand Rapids: Zondervan, 1996), where each author presents his view and responds to the other four views. Generally speaking, views 1-2 are similar as both are Reformed (stressing continuity between the NT and OT) and these stand against views 3-5 which are alike in stressing discontinuity. In my opinion, the dispensational view has the most to commend it as law in the NT is never broken into component parts and this view clearly distinguishes Israel from the church. Further, it is inconsistent to change the Sabbath (Saturday) to Sunday but not apply the OT penalties for Sabbath-breaking today (i.e., death by stoning; cf. Exod. 31:14-15; 35:2).

## Does the Law of Moses Apply to Me? (2 of 2)

*Evaluating the Five Main Views on the Law and the Christian*

	<b>Theonomic</b> Greg Bahnsen	<b>Reformed</b> Willem VanGemeren	<b>Weightier Issues</b> Walter C. Kaiser	<b>Modified Lutheran</b> Douglas J. Moo	<b>Dispensational</b> Wayne G. Strickland
<b>Strengths</b>	<ul style="list-style-type: none"> <li>• Continuity between the OT and NT upheld</li> <li>• Desires ethics to relate to all of life</li> <li>• Sees positive aspects of the law</li> </ul>	<ul style="list-style-type: none"> <li>• Continuity between the OT and NT upheld</li> <li>• Notes Mosaic law's foreshadowing of Christ</li> <li>• Sees a convicting role of the law today for unbelievers</li> </ul>	<ul style="list-style-type: none"> <li>• Biblical support for some law aspects (i.e., moral) being weightier than others (Matt. 23:23)</li> <li>• Holiness Code of Leviticus 18–19 stem from nature of God</li> </ul>	<ul style="list-style-type: none"> <li>• Accounts for new covenant emphases under the Law of Christ (Gal. 6:2)</li> <li>• Says OT laws repeated in the NT are applicable</li> <li>• Applies law principles today</li> </ul>	<ul style="list-style-type: none"> <li>• Biblical in that Mosaic law began at Sinai and ended with Christ's death as a temporary custodian or tutor (Gal. 3:19, 24-25)</li> <li>• Clearly distinguishes between Israel and church</li> <li>• Advocates continued guidance in law of Christ</li> </ul>
<b>Weaknesses</b>	<ul style="list-style-type: none"> <li>• Dividing law as moral, civil &amp; ceremonial not biblically supported</li> <li>• Misguided to apply godly commands to unregenerate man</li> <li>• All "law" need not be Mosaic (natural law and law of Christ also exist)</li> <li>• The NT never applies the OT to civil matters</li> <li>• Law condemned man (2 Cor. 3:9)</li> </ul>	<ul style="list-style-type: none"> <li>• Dividing law as moral, civil &amp; ceremonial not biblically supported</li> <li>• Use of "law" in differing ways inconsistent &amp; confusing</li> <li>• Requiring Sabbath for today contradicts NT (Col. 2:16-17)</li> <li>• Unclear if moral law became law of Christ</li> <li>• Merges Israel and church</li> </ul>	<ul style="list-style-type: none"> <li>• Dividing law as moral, civil &amp; ceremonial not biblically supported</li> <li>• Arbitrary to pick and choose which parts of the law are required</li> <li>• Choice of Decalogue and Lev. 18–19 too narrow for moral law</li> </ul>	<ul style="list-style-type: none"> <li>• Seeks to teach the indivisibility of the law while upholding its moral content</li> <li>• Too extreme to claim that the law has absolutely no purpose today</li> <li>• Fails to see the gospel in the OT by demarcating Law and Gospel into distinct, discontinuous eras</li> </ul>	<ul style="list-style-type: none"> <li>• Distinguishing law's revelatory aspects (eternal, revealing God's nature) from regulatory (temporary, ruled Israel) makes distinctions within an inseparable code—if the OT law is essentially a unity, then why divide it into two parts?</li> <li>• The law is not nullified but actually upheld by faith (Rom. 3:31)</li> </ul>

***Spectrum on Degree of Applicability\****

*Law as fully applicable in every sense*

**Theonomic**

**Reformed**

**Weightier Issues**

**Modified Lutheran**

**Dispensational**

*Law as fully abolished in every sense*

\* Adapted from Lee Hwee Chin, "The Applicability of the Law Today," unpublished research paper for the course "Old Testament Survey," Singapore: Singapore Bible College, 2001), 1.

## Should Christians Follow the Ten Commandments?

Adapted from my 1990 dissertation, "The Eschatological Significance of the Sabbath," Dallas Seminary, 148-53

Despite the popularity of the belief that the Law is presently valid for believers, the New Testament treats the entire law as abrogated.<sup>30</sup> This is a major tenant of the Book of Galatians, written in response to the error of supposing that some of the law was still in effect. Paul's readers were falsely lead into believing that *most* of the law was abrogated (e.g., the sacrificial system, dietary laws, etc.) but *certain* laws remained, circumcision in particular. Paul forcefully took issue with such teaching:

Mark my words! I, Paul, tell you that if you let yourselves be circumcised, Christ will be of no value to you at all. Again I declare to every man who lets himself be circumcised that he is obligated to obey the whole law (Gal. 5:2-3).

The issue to be emphasized here is Paul's view of the law as a whole. His point is that if one is required to keep *any* part of it, he is obligated to keep *all* of it. Conversely stated, if the believer is free from the law, he is free from *all* of it. This applies whether the part referred to is circumcision, the Sabbath, or any other part.<sup>31</sup>

The Pauline epistles uphold the abolishment of the *entire* law, not only part of it. Paul affirmed emphatically that believers are dead to the law (Rom. 7:1-6) and not under its rule (Rom. 6:14; Gal. 3:19, 23-29; 4:25, 31; 5:18). This is because Christ is the fulfillment (cf. Matt. 5:17-18) and termination or end of the law (Rom. 10:4) since His death abolished the law (Eph. 2:15). Further, Paul taught that the Mosaic Covenant has passed away (2 Cor. 3:6-11) and that the Abrahamic Covenant both preceded and followed the period of the law since the law served only temporarily (Gal. 3:14-25). The result is that "now that faith has come, we are no longer under the supervision of the law" (Gal. 3:25). Also, "the fact that God has (manifestly) accepted Gentiles as sons demonstrates that the period of the law is at an end; the custodian has finished his task and the son has become an heir (4:1-6)."<sup>32</sup> Finally, in 1 Corinthians 9:20 Paul very clearly declares himself free from the law:

To the Jews I became like a Jew, to win the Jews. To those under the law I became like one under the law (though I myself am not under the law), so as to win those under the law.

Paul could not have stated more clearly that he was not under the law. He makes the same claim for his Roman readers as well: "you are not under law, but under grace" (Rom. 6:14). The preceding verses represent only a select group of passages which indicate that the law has been abolished and thus has no jurisdiction over the believer. Indeed, when comparing the Mosaic dispensation with "the dispensation in Christ, Paul found the former, glorious as it had been, to be worthless."<sup>33</sup>

### Paul and the Decalogue

While many passages have been cited above to show the end of the law, those most pertinent to the present study are two texts specifically pointing to the end of the Ten Commandments in the present age. The first text is Romans 7. Here Paul emphatically states that the believer has died

<sup>30</sup>Douglas J. Moo, "Jesus and the Authority of the Mosaic Law," *JSNT* 20 (February 1984): 3-49; Roy L. Aldrich, "Causes for Confusion of Law and Grace," *BS* 116 (July-September 1959): 221-29; id., "Has the Mosaic Law Been Abolished?" 322-35; id., "The Mosaic Ten Commandments Compared to Their Restatements in the New Testament," *BS* 118 (July-September 1961): 251-58.

<sup>31</sup>One may object to this reasoning based upon that fact that Paul used circumcision (in the so-called ceremonial law) rather than the Sabbath (in the so-called moral law), but Paul's teaching on the present applicability of the Ten Commandments is noted later in this discussion.

<sup>32</sup>Douglas R. de Lacey, "The Sabbath/Sunday Question and the Law in the Pauline Corpus," in *From Sabbath to Lord's Day: A Biblical, Historical, and Theological Investigation.*, ed. D. A. Carson, 159-95 (Grand Rapids: Zondervan, 1982), 166.

<sup>33</sup>E. P. Sanders, *Paul, the Law, and the Jewish People* (Philadelphia: Fortress Press, 1983), 144.

to the law by being joined to Christ (v. 4) with the result that he is released from the law (v. 6). His following illustration specifies this "law" as the Decalogue by referring to the tenth commandment which prohibits coveting (vv. 7f.). The purpose of this prohibition was to reveal Israel's inability to obey the law of God. Specifically, Paul claims freedom from the law because it has already fulfilled its purpose in revealing sin. Further, since the Decalogue is an essential unity, the abolition of one of its commandments (coveting) shows the abolition of them all.<sup>34</sup> In other words, since his illustration denotes that believers are free from *one* of the Ten Commandments, and the Decalogue is a unity, it follows that believers are also free from *all* of the commandments, which includes the Sabbath.

Second Corinthians 3 is a second passage which even more clearly shows the believer's freedom from the Ten Commandments. In this chapter Paul contrasts his apostolic authority as a minister of the New Covenant with that of his opponents at Corinth who, by implication, were ministers of the Old Covenant (cf. 2:17; 3:14). One reason the New Covenant is more glorious than the Old is because this New Covenant is internal, written on men's hearts through the Person or activity of the Spirit (3:3b).<sup>35</sup> Conversely, the Old Covenant was engraved upon tablets of stone (3:3, 7). The crucial issue here is *what* was written on stone in the Old Testament. Was it the entire law? No, only the Ten Commandments were engraved upon the tablets at Sinai (Deut. 4:13; 5:22).<sup>36</sup> In other words, Paul equates the Old Covenant with the Decalogue.<sup>37</sup> This law had a fading glory (i.e., lacked permanent validity)<sup>38</sup> "because only in Christ is it taken away" (v. 14b). Therefore, since Paul contrasts his continuing ministry of blessing with the ministry of cursing in the Ten Commandments, he in effect teaches the abolishment of the Decalogue as a system by which one should live, including the Sabbath.<sup>39</sup> That the Sabbath is included within this abolished Decalogue also finds support in that the death penalty for disobeying the Ten Commandments is never enforced in the New Testament.<sup>40</sup> It is inconsistent to argue for the continuance of the Sabbath requirement in the present age without a continued penalty for neglecting it.

<sup>34</sup>This is certainly not to say that believers are now free to covet, for this is prohibited elsewhere in the New Testament (e.g., James 4:2). What Paul means is that the prohibition of coveting in the Decalogue revealed man's inability to follow God's commands.

<sup>35</sup>Bernardin Schneider, "The Meaning of St. Paul's Antithesis 'The Letter and the Spirit,'" *CBQ* 15 (1953): 193-207.

<sup>36</sup>Charles Hodge, *A Commentary on 1 & 2 Corinthians*, GCS, 428. See also Exodus 24:12; 31:18; 32:15-16 for other verses mentioning the tablets. Many argue that Paul's reference to "tablets of stone" serves as a figurative designation for the entire law or Old Covenant (e.g., Victor Paul Furnish, *II Corinthians*, AB, 200; Bultmann, 73-75; Frederick W. Danker, *II Corinthians*, ACNT, 54; Colin Kruse, *The Second Epistle of the Paul to the Corinthians*, TNTC, 91-93; Knofel Staton, *Second Corinthians*, SBS, 56-57). However, the passage compares in graphic terms the actual writing (content) on the cold, external tablets with that "written" on the warm, internal heart; thus, the comparison drawn is between the Decalogue and that which replaces it—the work of the Spirit in the inner man. However, even if the tablets represent the *entire* law (the Old Covenant is the implied contrast in verse 6 and specifically mentioned in verse 14), this still argues for the abolition of the Sabbath as part of that law.

<sup>37</sup>De Lacey, "The Sabbath/Sunday Question and the Law in the Pauline Corpus," 167.

<sup>38</sup>Ernest Best, *Second Corinthians*, Interp., 31.

<sup>39</sup>Even Paul's statement that circumcision is nothing but rather what matters is "keeping the commandments of God" (1 Cor. 7:19) is inadequate proof that believers are to keep the Ten Commandments. There is no evidence that ἐντολῶν θεοῦ ("commandments of God") refers exclusively or even primarily to the Decalogue (C. K. Barrett, *I Corinthians*, 169; de Lacey, "The Sabbath/Sunday Question and the Law in the Pauline Corpus," 176). Objection to the preceding presentation of Paul's view of the Decalogue may also be based upon his appeal to the fifth commandment in Ephesians 6:1-3. However, here the primary motive for children obeying their parents is not the Decalogue, but because this is part of one's calling in Christ (4:1) and is right (v. 1b). The appeal to the Ten Commandments is at best a third motivation (ibid., 176).

<sup>40</sup>For an evaluation of the penalties for each of the Ten Commandments, see Aldrich, "The Mosaic Ten Commandments Compared to Their Restatements in the New Testament," 251-58. He shows how the believer is not under the Decalogue, but instead "he is under the eternal moral law of God which demands far more than the Ten Commandments. It calls for nothing less than conformity to the character of God" (p. 257).

## Contrasting the Abrahamic & Mosaic Covenants

Distinguishing these covenants provides a foundation for interpreting the OT and NT, especially the prophets as they look back on covenants with both Abraham (e.g., Ezek. 36–37, p. 508) and Moses (e.g., Lam. 1:3, p. 496). Knowing the conditional and temporal nature of the Law prevents misapplying obsolete commands to the Church today (e.g., Sabbath, charging interest to believers, tithing). Also, God's faithfulness to sinners becomes clear due to Abraham.

	<b>Abrahamic Covenant</b>	<b>Mosaic Covenant</b>
<i>Recipient (Date &amp; Place)</i>	Abraham as mediator for all nations 2060 BC, Ur of the Chaldees	Moses as mediator for Israel 1445 BC, Mount Sinai
<i>Scripture</i>	Genesis 12:1-3 (but formalized into a covenant in Genesis 15)	Exodus 20—31 is the heart of the covenant
<i>Between God &amp;</i>	A person (for a future nation)	A nation
<i>Scope</i>	Universal ("all peoples will be blessed through you")	Only Israel received the Law (Deut. 4:8; Ps. 147:20)
<i>Character &amp; Significance</i>	Grace (promises) —primary (what God will do)	Works (laws) —secondary (how God will do it)
<i>Promises</i>	Land, seed, and blessing (without indication of time of fulfillment)	Blessing for obedience and cursing for disobedience (Lev. 26; Deut. 28)
<i>Conditions</i>	Unconditional: "I will..."	Conditional: "If you will...then I will..."
<i>Participation</i>	Abraham asleep (Gen. 15:17)	Israel agreed to obey (Exod. 19:8)
<i>Analogy</i>	Father to son (royal grant)	Suzerain (superior king) to vassal (servant nation)
<i>Purpose</i>	Clarified Israel's blessings in general terms to motivate the nation towards righteousness by faith in God's provision of a wonderful future (Gen. 12:1; 15:1, 6)	Clarified how Israel could be blessed in the Abrahamic Covenant as soon and full as possible; didn't restate or expand the Abrahamic Covenant but revealed sin (Rom. 5:20; Gal. 3:19, 24)
<i>Form</i>	Oral (no written stipulations)	Written on tablets of stone & Pentateuch
<i>Emphasis</i>	Blessing over discipline/judgment (five "blessings" in Gen. 12:1-3)	Judgment/discipline over blessing (contrast Deut. 28:1-14 & vv. 15-68)
<i>Christology</i>	Ultimate seed (Gen. 12:3)	Typified in tabernacle (Heb. 8–10)
<i>Sign</i>	Circumcision (Gen. 17:11)	Sabbath (Exod. 31:13, 17)
<i>End</i>	Never been terminated (deemed an eternal covenant in Gen. 17:8)	Ended at Christ's death (Rom. 7:6; 10:4; 2 Cor. 3:7-11; Gal. 5:1; Heb. 7:11-12)

While most of the above is original, some is based on Thomas L. Constable, "A Theology of Joshua, Judges, and Ruth," in *A Theology of the Old Testament*, ed. Roy B. Zuck (Chicago: Moody, 1991), 100-101. For a more complete evangelical picture of the relevance of the OT law to the Christian, see *Five Views on Law and Gospel* (Zondervan), including modified Lutheran (Douglas J. Moo), Dispensational (Wayne G. Strickland), "weightier issues" apply (Walter C. Kaiser), Non-theonomic Reformed (Willem VanGemeren), and Theonomic Reformed (Greg Bahnsen).

## Israel & the Church: Continuity & Discontinuity

One issue over which a lot of scholarly ink flows is the extent to which Israel relates to the Church. Some (especially amillennialists, postmillennialists, and covenant premillennialists) argue that the Church is the “new Israel” with complete continuity between the two entities. Thus, the Church is seen to have simply replaced Israel and assumed her promises and covenants.

The other side of the spectrum of views is classical and revised dispensationalism which advocates the discontinuity model. In this scheme there are two separate peoples of God: Israel and the Church. The only overlap is that the believers today participate in some of the aspects of the Abrahamic and New Covenants (see p. 116 and supplements to the Jeremiah notes).

I have held both views, but now hold to a third model similar to progressive dispensationalism. This newer system (since 1987) emphasizes both continuity and discontinuity yet still maintains the dispensational distinctive that the Church is *not* the “new Israel.” Rather, it is a continuation of God’s covenant plan begun with Israel and continuing with a believing remnant of Israel today, along with Gentile believers who have been grafted into the Abrahamic Covenant (see Romans 9–11; Galatians 3). Here are some points of difference and contact between these two entities:

### Discontinuity

	Israel	Church
<i>Identity</i>	Physical seed of Abraham (Gal. 6:12-16)	Spiritual seed of Abraham (Gal. 3:7, 29)
<i>Land Covenant</i>	Still outstanding (Deut. 30:1-10) but partly fulfilled since 1948 (Ezek. 37:1-7)	No land promise (Land Covenant) can be claimed by present believers
<i>Law</i>	Required to obey the law (Exod. 19–20)	Freedom from the law (Rom. 7; Gal. 3)
<i>Duration</i>	Abraham (Gen. 12:1-3) to eternity (Jer. 31:35-37)	Pentecost (Acts 2) to Rapture (1 Thess. 4:13-18) or even later (?)
<i>Wrath</i>	Experienced in Tribulation (Jer. 30:7)	Free from wrath (1 Thess. 5:9; Rev. 3:10)
<i>Faith</i>	Shown in offering sacrifices	Shown in trusting Christ’s sacrifice
<i>Priesthood</i>	<i>Has</i> one: a special class by heredity	<i>Is</i> one: all are priests (1 Pet. 2:5)
<i>Activity</i>	Set aside between 69th & 70th “Weeks” (Dan. 9:24-27)—a part of the “times of the Gentiles” (Luke 21:24)	Between 69th & 70th “Weeks” the church is a mystery unforeseen in the OT (Eph. 3:1-9; Col. 1:26)
<i>Qualification</i>	Ethnic—descendants of Abraham or Gentile proselytes who became Jews through circumcision as blessing is through Israel (1 Kings 8:41-43; Isa. 2:2-3; 19:19-25; 49:6; 51:4; 56:6-8; Zech. 14:16-19)	Nonethnic—“Neither Jew nor Gentile” (Gal. 3:28) means a combination of Jews and Gentiles without need to become Jewish proselytes (Acts 15; Eph. 3:3, 6)

# Continuity

	Israel	Church
<i>Abrahamic Covenant</i>	Origin in Abraham as the father of the nation (Gen. 12:1-3)	Believers today are grafted into this same covenant (Rom. 11:17-21; cf. Gal. 3:29)
<i>Davidic Covenant</i>	Promise of a literal temple (2 Sam. 7:13) fulfilled by Solomon (1 Kings)	Functions now as a spiritual temple (Eph. 2:19-22; 1 Pet. 2:4-10)
<i>New Covenant</i>	Promised forgiveness of sins, indwelling Spirit, new heart, reunification of Israel and Judah, and knowledge of God throughout the earth (Jer. 31:31-34)	The first three aspects (forgiveness of sins, indwelling Spirit, new heart) true today in a progressive fulfillment of the covenant (Luke 22:20)
<i>Law</i>	Required to obey the Mosaic law (Exod. 19-20)	Required to obey the "law of Christ" (Gal. 6:2) or "law that gives freedom" (James 1:25; 2:12)
<i>Salvation by</i>	God's grace through faith (Gen. 15:6)	God's grace through faith (Rom. 4:3)
<i>Basis of Salvation</i>	Sacrificial lamb	Sacrificial Lamb
<i>Spirit</i>	Filling on leaders	Indwelling of all believers (Rom. 8:9)
<i>Prophets</i>	Provided revelation of God's word	Foundation of the church (Eph. 2:20)
<i>Election</i>	Based on grace (Mal. 1:2)	Based on grace (Eph. 1:4-6, 11)
<i>Disobedience</i>	Lead to God's discipline	Leads to God's discipline (1 Cor. 11:30)
<i>Leadership</i>	Elders (Exod. 3:16, 18; 4:29, 31; 12:21; Num. 11:16-17; Josh. 24:31; 1 Sam. 15:30; 2 Sam. 17:4, 15; 1 Kings 21:8, 11 and many other texts)	Elders (Acts 11:30; 14:23-24; 15:1-6; 16:4; 20:17-38; 21:17-26; 1 Thess. 5:12-13; Phil. 1:1; 1 Tim. 3:1-7; 4:14; 5:17-25; Tit. 1:5-9; Jas. 5:14; 1 Pet. 5:1-5; Heb. 13:17)
<i>God's Presence</i>	In a cloud at day and a pillar of fire at night (Exod. 40:34-38)	In the indwelling ministry of the Holy Spirit (1 Cor. 6:19)
<i>Witness</i>	"light for the Gentiles" (Isa. 49:3-6) "kingdom of priests" (Exod. 19:6) "holy nation" (Exod. 19:6)	"light of the world" (Matt. 5:14-16) "holy...royal priesthood" (1 Pet. 2:5, 9) "holy nation" (1 Pet. 5:9)

# The Tabernacle and Furnishings

*The Bible Visual Resource Book, 25*

Exodus

## The Tabernacle

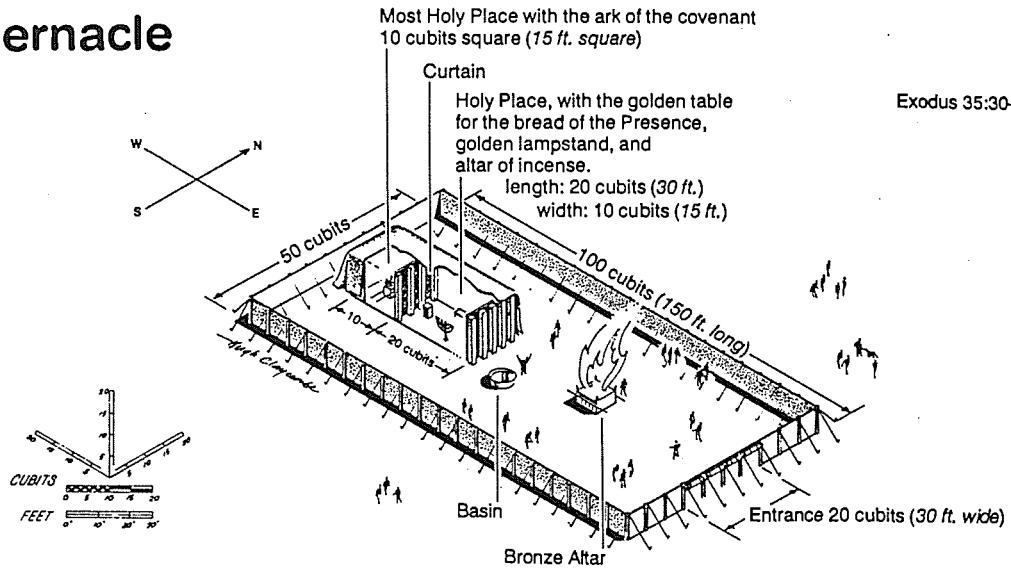

Exodus 35:30–36:38; 39:9–40:38

The new religious observances taught by Moses in the desert centered on rituals connected with the tabernacle, and amplified Israel's sense of separateness, purity and oneness under the Lordship of Yahweh.

A few desert shrines have been found in Sinai, notably at Serabit el-Khadem and at Timnah in the Negev, and show marked Egyptian influence.

Specific cultural antecedents to portable shrines carried on poles and covered with thin sheets of gold can be found in

ancient Egypt as early as the Old Kingdom (2800-2250 B.C.), but were especially prominent in the 18th and 19th dynasties (1570-1180). The best examples come from the fabulous tomb of Tutankhamun, c. 1350.

Comparisons of construction details in the text of Ex 25-40 with the frames, shrines, poles, sheathing, draped fabric covers, gilt rosettes, and winged protective figures from the shrine of Tutankhamun are instructive. The period, the Late Bronze Age, is equivalent in all dating systems to the era of Moses and the exodus.

© Hugh Claycombe 1981

## The Tabernacle Furnishings

Exodus 37–38:8

The symbolism of God's redemptive covenant was preserved in the tabernacle, making each element an object lesson for the worshiper. The Levitical priests, including some with Egyptian names and perhaps Egyptian training, gave meticulous attention to facts about the shrine. Reconstruction of the furnishings is possible because of extremely detailed descriptions and precise measurements recorded in Ex 25-40.

ARK OF THE COVENANT

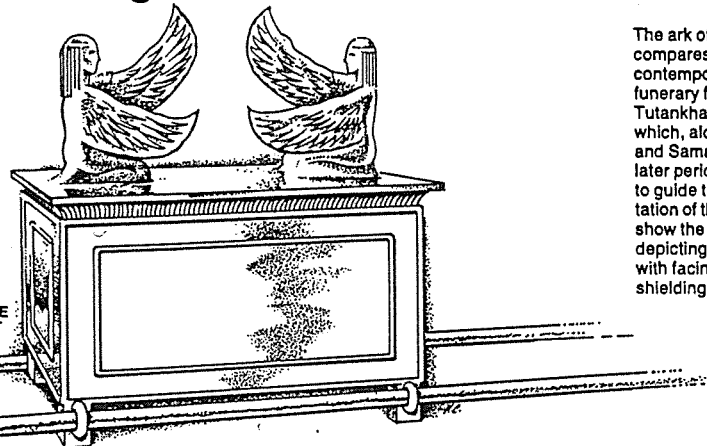

The ark of the Testimony compares with the roughly contemporary shrine and funerary furniture of King Tutankhamun (c. 1350 B.C.), which, along with the Nimrud and Samaria ivories from a later period, have been used to guide the graphic interpretation of the text. Both sources show the conventional way of depicting extreme reverence, with facing winged guardians shielding a sacred place.

### The Altar of Incense

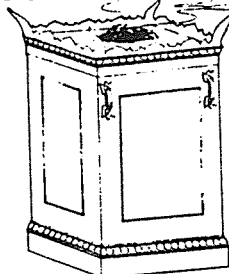

- Source Unknown

Exodus 30: 1-10 Read the description and purpose of the altar of incense.

The altar of incense was 1½ feet square and 3 feet high. Made of acacia wood overlaid with pure gold, it had rings on the corners in which to place long staves for carrying. The priests burned incense on the altar twice daily as an act of worship to the Lord (vv. 7-8). Elsewhere in Scripture, incense speaks of the worship of the saints (Rev. 5: 8; 8: 3-4).

- Source Unknown



## The Tabernacle Furnishings

Source Unknown

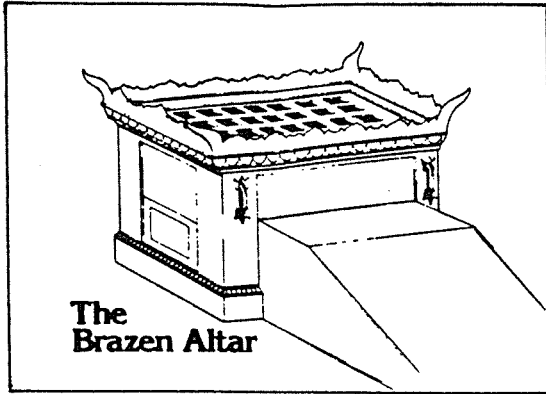

Exodus 27: 1-8. the dimensions (7½ feet square and 4½ feet high)

Note that it stood just inside the main gate of the court. Teach that the word altar means "slaughter place," and it was to this altar that the Israelites were directed to bring their animal sacrifices.

Note that when an Israelite presented a sacrifice he first placed his hands on the head of the animal and confessed his sins. He was thereafter identified with that animal. He then had to kill the animal, thereby indicating that the penalty of sin is death. The priest then took blood from the sacrifice and applied it in the proper place. At this point the animal was put on the altar. The altar pictures the cross where Jesus Christ poured out His blood as an atoning sacrifice for all mankind.

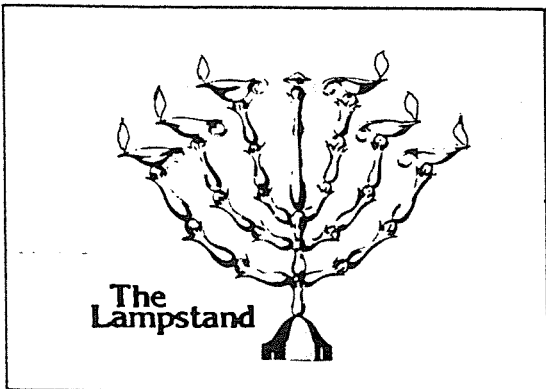

we are moving through the door and into the Holy Place. The next article is the golden lampstand, located against the south wall.

Exodus 25: 31-40. Note the ornate craftsmanship that went into its construction.

The purpose of the lampstand was to give the light needed by the priests as they went about their duties and worship in the Holy Place. Again, no dimensions are given, but we know it was formed of pure gold. The lampstand suggests the church, the body of Christ. Although Christ is the source of spiritual light (John 8: 12), He said we are the light of the world (Matt. 5: 14). As we allow His light to shine through us, we become His candlesticks. Placed by Him in sin's dark places, we reflect His glorious light (John 12: 36). The oil needed for fuel is representative of the Holy Spirit who provides means and power for the Christian today.

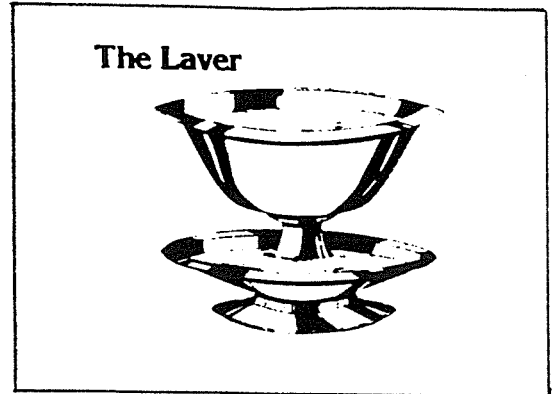

(Exod. 38: 8). the word *laver* literally means "lavatory," or a "place for washing."

Before entering the tent, the priests washed their hands and feet at the laver. Although no dimensions are given in Scripture, the laver was certainly large enough to accommodate them. The laver represents our being cleansed from sin before entering into fellowship with God. For the Christian it means applying 1 John 1: 9, that is, confessing our sin and claiming the forgiveness and cleansing that God promises through the shed blood of Jesus Christ.

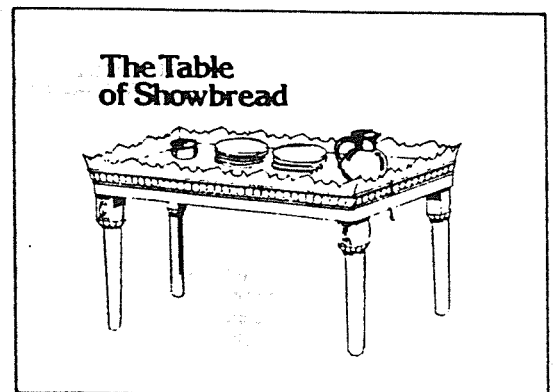

Exodus 25: 23-30.

The table of showbread was constructed from acacia wood and overlaid with pure gold. It was rather low (only 2½ feet high) and its outside dimensions were one foot by three feet. On it were placed twelve small cakes of bread and the utensils, which were made of pure gold.

The bread, after it had been displayed, served as food for the priests. Actually, the consumption itself was an act of worship.

The application for the Christian is two-fold. First, Christ is the Bread of Life (John 6: 35), that is, He is our portion, our eternal provision. Second, "man shall not live by bread alone, but by every word of God" (Luke 4: 4). We are to partake daily of our spiritual food, the Bible God's Word.

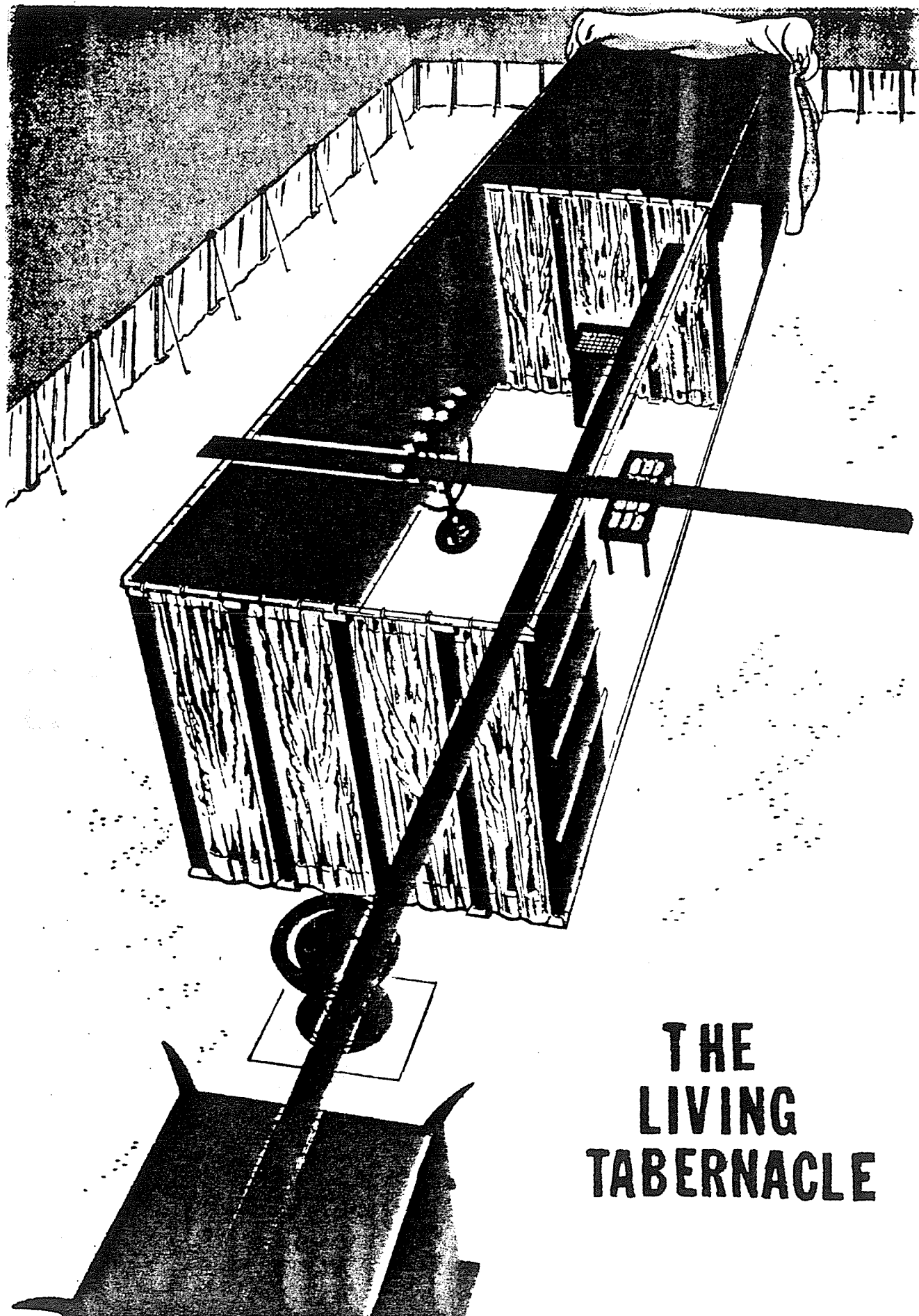

**THE  
LIVING  
TABERNACLE**

# ◀ THE TABERNACLE IN THE WILDERNESS ▶

A FIGURE      A SHADOW

HEB. 9: 8,9 & 24

HEB. 10: 1

Source Unknown

## EXAMPLES ~ PATTERN

HEB. 8:5

I COR. 10:11

### THE HIGH PRIEST

EX 28:1 ~ HEB 8:1, 2

HEB 7:24, 25 ~ I JOHN 2:12

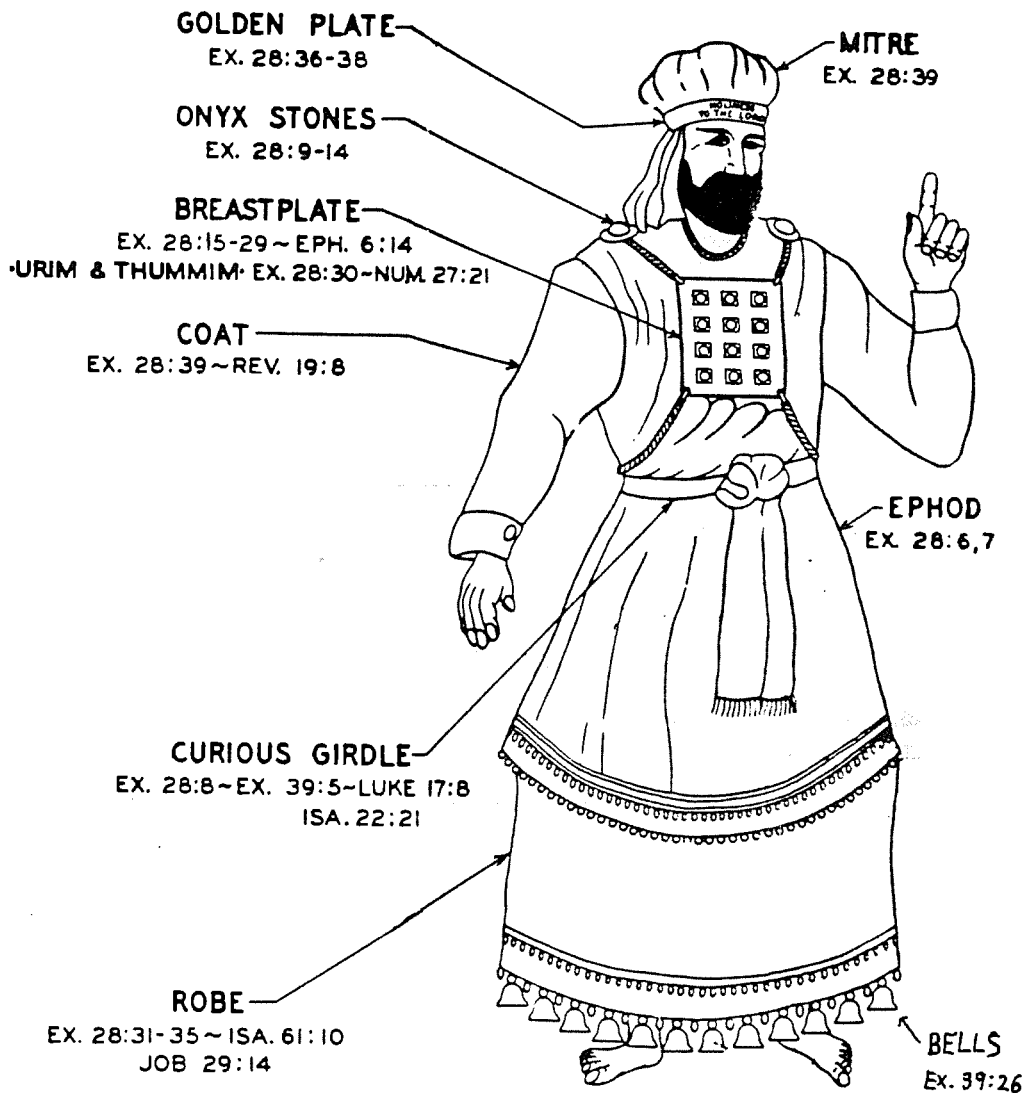

## The Tabernacle & Creation

The typological significance of the tabernacle has been widely taught, for truly the tabernacle looked *forward* to the finished work of Christ (see previous pages). However, a little-discussed topic is how the tabernacle looked *back*—specifically to the creation event.

John H. Sailhamer, *The Pentateuch as Narrative: A Biblical-Theological Commentary* (Grand Rapids: Zondervan, 1992): 298-300 shows many interesting parallels between these two events:

	Creation	Tabernacle
<i>Text</i>	Genesis 1-2	Exodus 25-31
<i>Content</i>	Creation of the heavens and earth	Building of the tabernacle
<i>Significance</i>	Arena in which God would have fellowship with humans	Means of restoring man's lost fellowship with God
<i>Structure</i>	Seven acts marked by divine speech: "And God said" (Gen. 1:3, 6, 9, 14, 20, 24, 26; cf. vv. 11, 28, 29)	Seven acts marked by divine speech: "And the LORD said" (Exod. 25:1; 30:11, 17, 22, 34; 31:1, 12)
<i>Contents</i>	Pure gold (Gen. 2:12a) and precious jewels (Gen. 2:12b)	Pure gold (Exod. 25:3) and precious jewels (Exod. 25:7)
<i>Final Inspection &amp; Blessing</i>	"And God saw all he had made, and behold, it was very good" (Gen. 1:31); God blessed man (Gen. 1:28)	"And Moses saw all the work, and behold, they had done it just as the LORD had commanded" (Exod. 39:43a) and Moses blessed them (Exod. 39:43b)
<i>Closing</i>	Reminder that God rested on the sabbath (Gen. 2:1-3)	Reminder to observe the sabbath (Exod. 31:12-18)
<i>Patterns</i>	Man and woman made in God's image (Gen. 1:26-27)	Tabernacle made based on the pattern God showed Moses (Exod. 25:9)
<i>Sequel</i>	Fall of man into the sin of eating the forbidden fruit (Gen. 3)	Fall of Israel into the worship of the golden calf (Exod. 32)

What, then, is the significance of these parallels?

1. The tabernacle was intended as a *model of God's heavenly abode* in that God's presence would dwell with His people.
2. As the tabernacle followed the "pattern" of something in heaven, it had a *symbolic as well as practical purpose*. The physical forms also had spiritual meaning or sense to them (typology).

However, the text gives no hints as to their typology, leaving their meanings a mystery. We have to wait until we get to the NT to see it as a picture of the work of Christ (John 2:19-21; Heb. 8:2; 9:11-12), the individual believer (1 Cor. 6:19), and the church (1 Tim. 3:15; Heb. 3:6; 10:21).

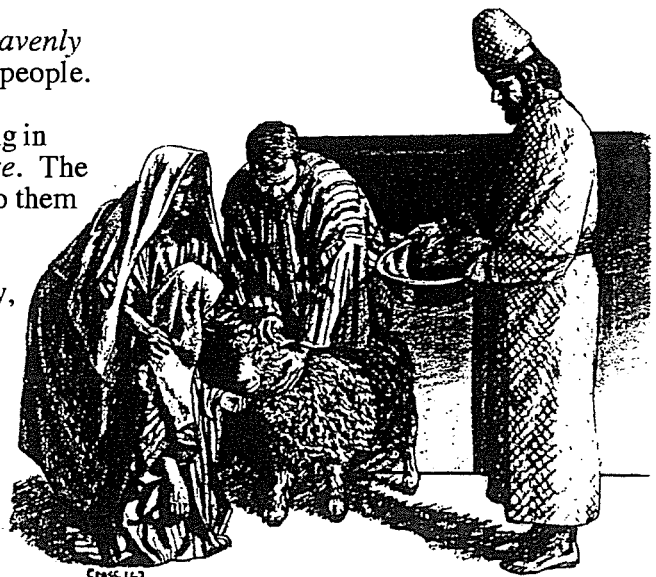

## Salvation in the Old Testament

How were people saved during Old Testament times? Were only Jews saved? How? Was it through the tabernacle and temple sacrifices? Did killing these animals actually forgive sin? These questions will naturally arise in a thinking person’s mind when encountering the OT.

First, salvation has always been by faith and not by works of the Law. This is Paul’s key point in Galatians and Romans and it applies to all times. Paul gives Genesis 15:6 as support: “Abraham believed God, and it was credited to him as righteousness” (Rom. 4:3; cf. vv. 11, 16-24; Heb. 11). Salvation in all ages is based in God’s grace, not our works (Eph. 2:8-9). The ways He has shown His grace has changed over the ages, but His method of salvation by grace through faith is constant.

OT believers expressed their faith in many ways: worshipping God, offering sacrifices, or doing good deeds, but it was their *faith* that saved—not their sacrifices or worship or deeds. Their faith was placed in God’s provision of a coming Saviour (1 Pet. 1:10-12), though they did not realise that this Redeemer specifically was Jesus Christ. Further, there is no hint that their salvation could be lost.

One may ask, “But doesn’t the OT say sacrifices forgave people?” Leviticus promises Israelites that they “will be forgiven” by sin offerings and guilt offerings (4:20, 26, 31, 35; 5:10, 13, 16, 18; 6:7; 19:22; cf. Heb. 9:13). However, these refer to any *specific* sin rather than forgiveness from *all* sin for salvation; also, ritual without repentant faith was useless (Ps. 40:6-8; Isa. 1:11-20; Jer. 7:21-26).

This parallels our experience some. We are saved from the penalty of sin by faith, just like Jews (and Gentiles identifying with Israel) in the OT—but we show faith by trusting Christ as our past sacrifice rather look forward to a future sacrifice. We still sin, but 1 John 1:9 promises, “If we confess our sins, he is faithful and just and will forgive us our sins and purify us from all unrighteousness.” We have *positional* forgiveness for all sins (past, present, and future) and a secure relationship with God. However, confession helps us experience *practical* forgiveness and restoration of our fellowship with Him. In like manner, Job sacrificed for cleansing and restored fellowship while saved (Job 42:7-9).

But why can’t the “blood of bulls and goats...take away sins” (Heb. 10:4)? Sacrifices forgave and cleansed only from external ceremonial impurity (Heb. 9:13), but Christ *removed* all sin and cleansed *internally*. A clear treatment of OT sacrifices is John S. Feinberg, “Salvation in the Old Testament,” *Tradition and Testament*, eds. John S. and Paul D. Feinberg (Chicago: Moody, 1981), 39-77 (adapted below into chart form). Issues 1-3 are the same for OT and NT but 4-5 are different:

	OT Times (Moses to Christ’s Death)	NT Times (Christ’s Death to Today)
<b>Basis of Salvation</b>	God’s gracious provision of the death of Christ since “it is the blood that makes atonement for one’s life” (Lev. 17:11b)	God’s gracious provision of the death of Christ (“without the shedding of blood there is no forgiveness” Heb. 9:22)
<b>Requirement of Salvation</b>	Faith in the provision that God has revealed—as a gift (Ps. 51:16-17)	Faith in the provision that God has revealed—as a gift (Gal. 2:16)
<b>Ultimate Content of Salvation</b>	Object of faith is God Himself—prophets exhorted repentance, not sacrifices (Jer. 3:12; Joel 2:12)	Object of faith is God Himself—heroes of faith are cited to exhort faith in God (Heb. 11)
<b>Specific Revealed Content of Salvation</b>	Cumulative content of faith involved sacrifices & promises: animals (Gen. 3:21); Abel’s sacrifice (Gen. 4:4); Abrahamic covenant (Gen. 15), etc.	New content of faith is the shed blood of Jesus Christ (1 Pet. 1:18-21) which removes sin while OT sacrifices merely covered sin
<b>Believer’s Expression of Salvation</b>	Obey moral law, offer animal sacrifices, obey Mosaic law (civil and ceremonial aspects)	Obey moral law, observe Lord’s Supper and baptism, etc. through the Spirit’s enabling (Rom. 8:9)

## Israel versus Pagan Culture

Summarized and expanded from Homer Heater, Jr., "Ancient Middle Eastern Culture and the Bible"  
(Professor's unpublished paper in doctoral seminar, Dallas Theological Seminary, 1989)

When comparing Scripture with the many archaeological finds present today, two dangers must be avoided. First, one must not assume that Israel took all of its beliefs from the nations surrounding it so that the nation had nothing different about it. Many unique elements do exist in the Old Testament.

The second danger is at the opposite extreme: to assume that since Israel's religion had a divine origin, *none* of the elements find parallels in the Ancient Near East. God's institution of Israel at Mount Sinai had several points of contact with other religions of that time.

In summary, Israel's relationship with pagan cultures had both similarities and differences:

Similarities	Differences (Uniquenesses)
<p><u>Mesopotamian Filial Adoption</u>: A childless couple could adopt an adult outside the family to take care of them in their old age and perform religious rites in exchange for an inheritance (Gen. 15:2-4; cf. Kenneth Kitchen, <i>The Bible and Its World</i>, 70).</p>	<p><u>Monotheism</u>: Whereas all Ancient Near East cultures worshipped more than one god (polytheism), Israel worshiped Yahweh alone (monotheism). While many scholars advocate that monotheism began with Moses, the Bible <i>begins</i> with one Creator God (Gen. 1:1).</p>
<p><u>Mesopotamian Birthright</u>: The oldest (or principal) son received a double share of the inheritance (Deut. 21:15ff.).</p>	<p><u>Unconditional Covenants</u>: God called Abraham and made a unique covenant with him in that Abraham need not fulfill any requirements (Gen. 12:1-3). This is seen in particular in the Mesopotamian ceremony in which Abraham did not accompany God between the animal halves (Gen. 15:17).</p>
<p><u>Law-Code Form</u>: The Bible uses the suzerain-vassal treaty form common during the 15th century (Book of Deut.). This included many of the same elements due to common institutions (marriage, government, private ownership) and common problems (death, murder, theft, slavery, etc.).</p>	<p><u>Law-Code Basis</u>: Israel was commanded not to sin because the LORD so willed it, which is a moral-ethical element lacking in all other law codes of antiquity.</p> <p>Also, whereas other codes were based upon a civil government, Israel's was divinely instituted under a theocratic government.</p>
<p><u>Canaanite Language</u>: The Canaanites (northwest Semitic people of western Syria and Palestine before 12th century BC) shared a similar Semitic language as Israel, making borrowing possible, as seen in the Psalms. However, Canaanites had two alphabetic writing systems: at Ugarit and one also influencing later Phoenician. In this respect they surpassed Israel linguistically.</p>	<p><u>Canaanite Technology</u>: Canaanites were also more technologically advanced than Israel, especially in working with metals. Thus their iron chariots controlled the western plains and Valley of Jezreel in Palestine. The Phoenicians were the same people as the Canaanites, but after the 12th century. Forced out of Palestine in the 13-12 centuries, they became the greatest mariners and traders of all times. They spread the Canaanite culture, religion, language, and alphabet all over the Mediterranean area.</p>

<p><u>Animal Sacrifice</u> was part of all ancient religious systems. Conservative scholars assume that God instituted sacrifice to Adam and his descendants (Gen. 3:21), but after Noah it was perverted.</p>	<p><u>Demoralizing Canaanite Cultic Practices</u> held them back from being a truly great culture. These practices were the worst in the entire near east, including human sacrifice, sacred prostitution, eunuch priests, serpent worship, and brutal mythology with gods against gods. Canaanite sexual religion with its high god El, wife Asherah, and offspring in Baal and Dagon are related to the pagan “Queen of Heaven” (Jer. 7:18; 44:17), Roman sexual deities (Venus, Diana, Aphrodite) and Catholic Mariology. All these were part of the virgin cult which originated from earliest times in Babylonian mystery religion.</p>
<p><u>The Tabernacle</u> instituted and built at Mt. Sinai had many similarities with those of pagan religions: portability, inner and outer courts, use of gold, sacrificial altars, priesthood, etc. (cf. p. 119 of these notes).</p>	<p><u>The Tabernacle</u> of Judaism was also unique in some respects. For one, its specifics were designed by God Himself (Exod. 25—27) though it was built by men (Exod. 36:8—40:33). Also, it had God’s very presence in the form of a pillar of fire at night and a pillar of cloud at daytime (Exod. 40:34-38).</p>
<p><u>Prophets</u>: Men who delivered “messages” from Dagon or other deities to pagan kings such as to the king at Mari appear in societies other than Israel.</p>	<p><u>Prophecy</u>: Pagan prophets gave briefer messages which were always in the king’s political or military interests and sometimes with promise or threat, depending upon the king’s response (Kitchen, 54-55). In contrast, Israel’s prophets such as Nathan, Amos, Hosea, or Isaiah reprovved and admonished even kings on issues of personal morality, social justice, or obedience to God. For a contrast between pagan and Israelite prophets, consult 1 Kings 22.</p>

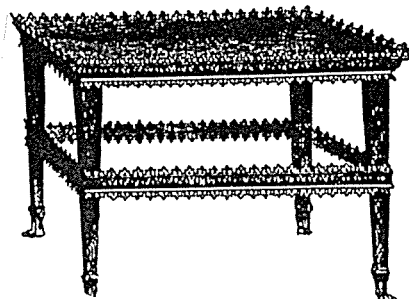
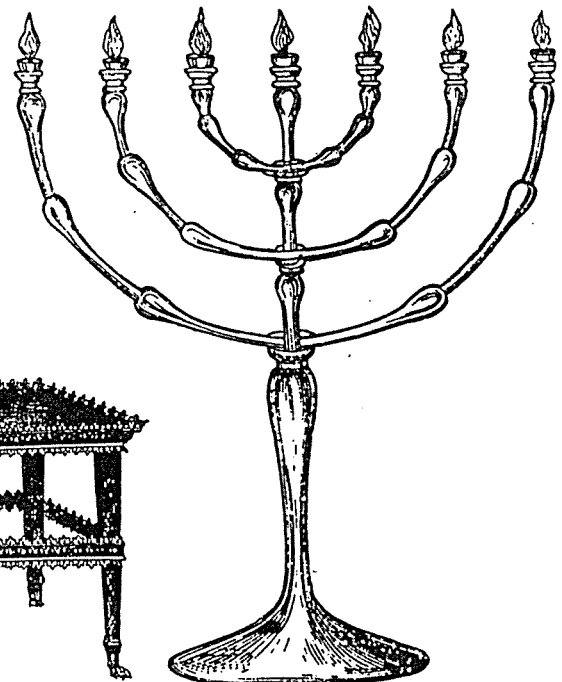
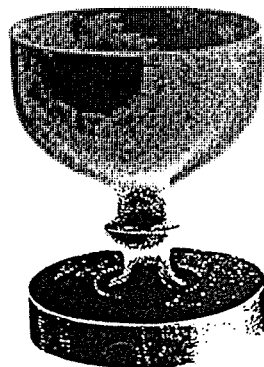

**HERE'S AN ISSUE FOR YOUR SMALL GROUP...**

**Which is the most accurate depiction of salvation in the OT and NT?**

*Salvation by...*

<b>OT</b>	Works	Faith + Works	Faith Alone	Faith + Works
<b>NT</b>	Faith	Faith Alone	Faith Alone	Faith + Works

**Which verses in the Bible support your answer?**

**DISTINGUISHING SALVATION AND SANCTIFICATION**

	<b>Man's Role</b>	<b>God's Response</b>	<b>Life of Faith</b>	<b>Restored Fellowship</b>
<b>OT</b>				
<b>NT</b>				



# Leviticus

## Sanctification through Sacrifice and Separation

**Purpose:** that the LORD might be able to remain with the nation

**Place:** Mount Sinai

**Time:** One Month

**Chapters 1–10**

**Chapters 11–27**

**Sacrifice**

**Separation**

**Worshipping a Holy God**

**Walking with a Holy God**

**Securing Fellowship with God**

**Continuing Fellowship with God**

**Approaching God**

**Appeasing God**

**Perfect Sacrifices**  
(1–7)

**Perfect Priests**  
(8–10)

**Laws of Sanctification for...**  
(11–27)

Uncleanness (11–15)	Unintentional Sin (16)	Tabernacle (17)	Crimes (18–20)	Priests (21–22)	Worship (23–24)	Canaan (25–26)	Vows (27)
------------------------	---------------------------	--------------------	-------------------	--------------------	--------------------	-------------------	--------------

**Key Word:** Sanctification (Holiness)

**Key Verse:** “I am the LORD your God; consecrate yourselves and be holy, because I am holy... I am the LORD who brought you up out of Egypt to be your God; therefore be holy, because I am holy” (Leviticus 11:44-45; repeated in 19:2; 20:7, 26)

**Summary Statement:**

Leviticus teaches sanctification through sacrifice and separation that Israel might obey the laws demanded by God for His presence to remain with the nation.

**Application:**

We as believers need to continually separate (sanctify) ourselves by confessing our sin and walking in holiness before God in order to experience His presence with us.

**For Further Study:**

John S. Feinberg defends the issue of how OT sacrifices actually forgave sin in his chapter “Salvation in the Old Testament,” in *Tradition and Testament: Essays in Honor of Charles Lee Feinberg*, eds. John S. and Paul D. Feinberg (Chicago: Moody, 1981), 39-77 (esp. 59-75). See also my OTS, 119e summary of this chapter.

# Leviticus

## Introduction

**I. Title** Leviticus may be deemed a strange title since the book primarily concerns the *priestly* ceremonies and institutions, whereas the Levites are mentioned only once (25:32). However, since Aaronic priests were from the tribe of Levi and the sacrificial system which they administered is commonly called Levitical, this title is justified (Lindsey, *BKC*, 1:163). The Hebrew title is simply "And He Called" (וַיִּקְרָא *wayyiqra*) from the first word (1:1).

## II. Authorship

- A. External Evidence: The ancient testimony uniformly attributes the authorship of Leviticus to Moses. Christ Himself held to this tradition as He referred to the leprosy law of cleansing (Lev. 14:2-32) as written by Moses (Matt. 8:4; Mark 1:44).
- B. Internal Evidence: Leviticus does not specifically designate its author, but the first word continues the account from Exodus, which does claim Mosaic authorship (Exod. 17:14; 24:4, 7; 34:27-28; cf. Deut. 31:9, 24). Also, as its contents were revealed to Moses at Sinai (7:37-38; 26:46; 27:34) it makes sense that he is the one who recorded them here. The book also evidences a consistency of style characteristic of a single author.

## III. Circumstances

- A. Date: Mosaic authorship places the writing in his lifetime (1525-1405 BC). Since the tabernacle was set up exactly one year after the Exodus (Exod. 40:17) and the Book of Numbers resumes one month later (Num. 1:1), the intervening Book of Leviticus must cover only one month (in 1444 BC). Moses probably recorded these laws shortly after they were given in 1444 BC.
- B. Recipients: Moses died before Israel entered the Promised Land so the original readers comprised the Jews in the wilderness with him.
- C. Occasion: Exodus 25–27; 35–40 records how the tabernacle was constructed for use in the worship of Israel. However, while the people had all the equipment they still did not know *how* this tabernacle worship should be conducted. Leviticus fills in this gap. Moses knew that he would be passing on while the nation of Israel continued for generations, so he wisely and under the direction of the Spirit recorded the specific regulations in Leviticus as a written record of God's will concerning the worship and walk of the new nation.

## IV. Characteristics

- A. "The Book of Leviticus was the first book to be studied by a Jewish child; yet it is often among the last books of the Bible to be studied by a Christian. However, a book referred to about 40 times in the New Testament should be of great significance to every Christian" (*BKC*, 1:163).
- B. Leviticus reveals more information about the sacrificial system under the Law of Moses than any book in Scripture and provides the necessary background for a proper understanding of the Book of Hebrews in the New Testament.

## Argument

Leviticus teaches two general means of sanctification for the new-nation of Israel so that the people might be holy as God is holy (11:45). These two means appear in both major parts of the book, but sacrifices are more prominent in the first half (chs. 1–10) and separation from the pagan practices of Israel's neighbors occupy the major thrust in the latter half (chs. 11–27). The reason the nation needs to be sanctified is because God's presence cannot dwell with a wicked people.

## Synthesis

### Sanctification through sacrifice and separation

<b>1—10</b>	<b>Sacrifice (worshipping God)</b>
1—7	Five offerings
1:1—6:7	General instructions for the people
1—3	Consecration/voluntary: burnt, grain, fellowship
4:1—6:7	Cleansing/obligatory: sin, guilt
6:8—7:38	Specific instructions for the priests
8—10	Proper priestly service
8	Ordination of Aaron
9	Sacrifices begin
10	Unauthorized practice—death
<b>11—27</b>	<b>Separation (walking with God)</b>
11—15	Uncleanness
11	Animals
12	Childbirth
13—14	Leprosy (skin/mildew)
15	Discharges
16	Day of Atonement
17	Tabernacle/Blood
18—20	Crimes
18	Sexual
19	Social
20	Capital
21—22	Priestly restrictions
21	Personal
22	Sacrificial
23—24	Worship
23	Feasts
24:1-9	Daily oil/weekly bread
24:10-23	Death for blasphemer/murderer
25—26	Canaan
25	Special years (Sabbatical, Jubilee)
26	Blessings and curses
27	Vows

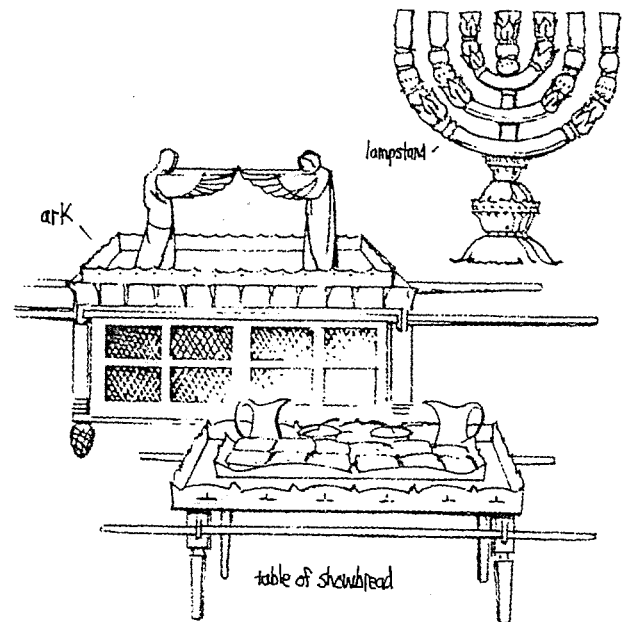

## Outline

### Summary Statement for the Book

Leviticus teaches sanctification through sacrifice and separation that Israel might obey the laws demanded by God for His presence to remain with the nation.

- I. (Chs. 1—10) Laws of sanctification by *sacrifice* through priestly mediation teach Israel how to maintain fellowship with God so that His presence might remain with the nation.
  - A. (Chs. 1—7) Instruction concerning sacrifices is given to both the people and priests to instruct Israel in sanctification by sacrifice so that God's presence might remain with the nation.
    1. (1:1—6:7) General sacrificial information is provided for the people to know how to offer sacrifices when both in and out of fellowship with God.
      - a. (Chs. 1—3) Sacrificial regulations for consecration are detailed to instruct the people how to approach God when in fellowship.

- 1) (Ch. 1) The burnt offering is a voluntary sacrifice which totally consumes the animal for a worshipper to draw near to God in total dedication.
  - 2) (Ch. 2) The grain (meal) offering is a voluntary, auxiliary, bloodless offering for a worshipper to show thanks to God for His provisional care.
  - 3) (Ch. 3) The fellowship (peace) offering is a voluntary communal sacrifice for a worshipper to express thanksgiving, a vow, or devotion to God (cf. 7:12-16).
- b. (4:1—6:7) Sacrificial regulations for cleansing are detailed to instruct the people how to approach God when out of fellowship.
- 1) (4:1—5:13) The sin offering is an obligatory sacrifice for a worshipper to make atonement (i.e., appease God's wrath) for unintentional sins.
  - 2) (5:14—6:7) The guilt (trespass) offering is an obligatory sacrifice for a worshipper to make restitution for withholding proper due from God or man.
2. (6:8—7:38) Specific sacrificial information is provided for the priests to know the administrative details of how to offer the foregoing offerings acceptably before God by identifying which persons, places, and portions were acceptable to God.
- B. (Chs. 8—10) The ordination of the priests, inauguration of the sacrifices, and deaths of Nadab and Abihu are given to demonstrate divine approval of proper priestly service and disapproval of unauthorized practices so that God's presence might remain with the nation.
1. (Ch. 8) The ordination of Aaron and his sons is performed to consecrate them as representatives of God for the people.
  2. (Ch. 9) The sacrificial system is inaugurated with God's blessing upon the beginning of the priests' ministry to acknowledge divine authority for the institution.
  3. (Ch. 10) Nadab and Abihu die from an unauthorized ceremonial practice to teach the nation the severe consequences of deviating from God's sacrificial pattern.

**II. (Chs. 11—27) Laws of sanctification by *separation* show the new nation how to live holy before God rather than identify with pagan neighbors so that His presence might remain with the nation.**

- A. (Chs. 11—15) Instruction concerning uncleanness is given to separate Israel from the practices of pagan neighbors as a holy people of God who can worship Him acceptably so that His presence might remain with the nation.

For some amazing ways that God protected Israel from diseases by obeying these precepts, see S. I. McMillen, *None of These Diseases* (Old Tappan, NJ: Revell, 1963, 1984; revised, updated & expanded, Singapore: Aeon Int'l & ValuPrint, 1997) and p. 131 of these notes.

1. (Ch. 11) Clean and unclean animals are designated to separate Israel from the practices of pagan neighbors as a holy people of God so that His presence might remain with the nation.
2. (Ch. 12) Childbirth regulations note that postnatal discharges render a woman unclean for bringing a sinner into the world, so she must wait a period of time before worshipping acceptably.
3. (Chs. 13—14) Infectious skin disease and mildew regulations are addressed as unclean to prevent advanced leprosy so that the nation's worship of God might not be disrupted.
4. (Ch. 15) Human discharges for men and women are designated unclean as they indicate a lack of wholeness required for acceptable worship.

- B. (Ch. 16) The Day of Atonement is given to cleanse the sanctuary from the pollution of the nation's unintentional sin to make possible God's continued presence among His people.
- C. (Ch. 17) Sacrifice is limited to the tabernacle and eating blood is forbidden so that Israel will not identify with the practices of pagan neighbors.
- D. (Chs. 18—20) Laws of sanctification for crimes in the sexual and social order are detailed with capital crimes to prevent Israel from imitating pagan practices in order that God's presence might abide with the people.
1. (Ch. 18) Laws restricting sexual relations are given to protect marriage and family life in Israel in contrast to the destructive practices of Egypt and Canaan.
  2. (Ch. 19) Laws of the social order are provided to promote practical holiness within Israel so that God's sovereign and holy presence might abide with the people.
  3. (Ch. 20) Laws requiring capital punishment (except vv. 19-21) denote the gravest religious and family sins to rid the community of pagan influences.
- E. (Chs. 21—22) Laws of sanctification in priestly restrictions are delineated to uphold a higher standard as leaders that God's name not be profaned.
1. (Ch. 21) Personal restrictions for priests concerning mourning, marriage, and physical defects hold a higher standard of holiness for them as Israel's leaders.
  2. (Ch. 22) Sacrificial restrictions for the priests' eating of sacred offerings and offering of unacceptable sacrifices holds them accountable not to profane God's name by misusing offerings.
- F. (Chs. 23—24) Laws of sanctification in worship are commanded for Israel to fulfill conditions for God's presence to remain with the nation.
1. (Ch. 23) Laws of the annual sanctified feasts are explained in the order they occur during the year to enable Israelites to worship God together as a nation and recall His mighty deeds on their behalf.
  2. (24:1-9) Laws of daily oil and weekly bread for Israel's worship is commanded to fulfill conditions for God's presence to remain with the nation.
  3. (24:10-23) Capital punishment for a blasphemer (and murderers) is commanded by God to illustrate how Levitical laws need to be applied to specific historical situations.
- G. (Chs. 25—26) Laws of sanctification in Canaan through special years and punishment for disobedience are addressed to encourage the nation to obey the covenant rather than bear the consequences of disobedience.
1. (Ch. 25) Laws of special years place all Israelites on equal social level in food and land usage to remind them that they serve as tenants of a land which is really God's.
    - a. (25:1-7) The Sabbatical Year prohibits organized farming every seventh year to place landowners and those who own no land on equal level by allowing all to eat any produce.
    - b. (25:8-55) The Year of Jubilee allows reacquisition of land formerly deeded away to remind Israel that the nation serves as tenants of land which is really God's.
  2. (Ch. 26) Blessings for obedience and curses for disobedience spell out the requirements for Israel to either prosper or fail in the land to encourage the people to obey the covenant rather than bear the consequences of disobedience.

- a. (26:1-13) Blessings for obedience detail the requirements for Israel to prosper in the land to encourage the people to obey the covenant.
- b. (26:14-46) Curses for disobedience detail how Israel could fail in the land to encourage the people to obey the covenant rather than bear these consequences.

H. (Ch. 27) Laws of sanctification through vows cite allowable and prohibited things to dedicate to the LORD in order to caution Israel against making rash vows.

- a. (27:1-25) The consecration of allowable things include persons, animals, houses, and lands at extremely expensive prices to discourage rash vows.
- b. (27:26-33) The prohibition of firstborn animals, devoted things, and tithes from being consecrated cautions Israel from trying to "give" God what is already His.

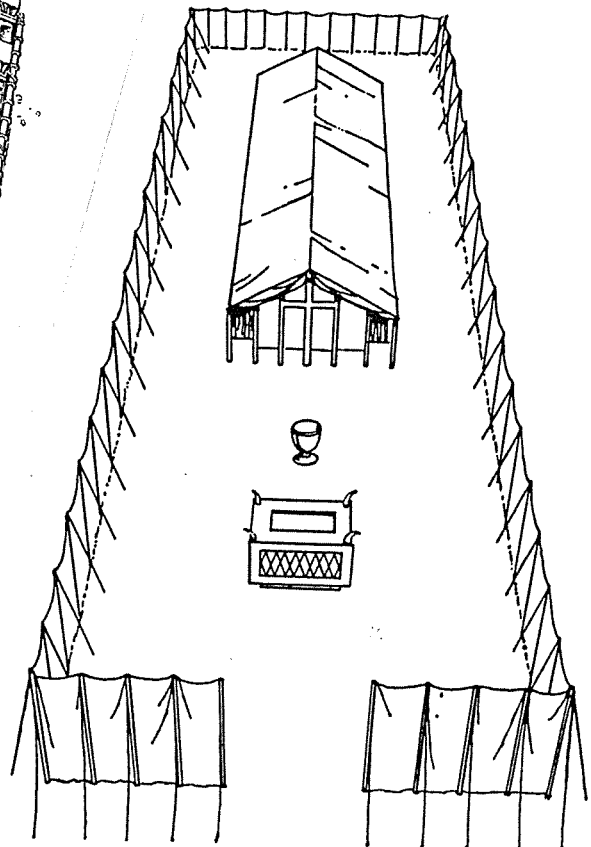
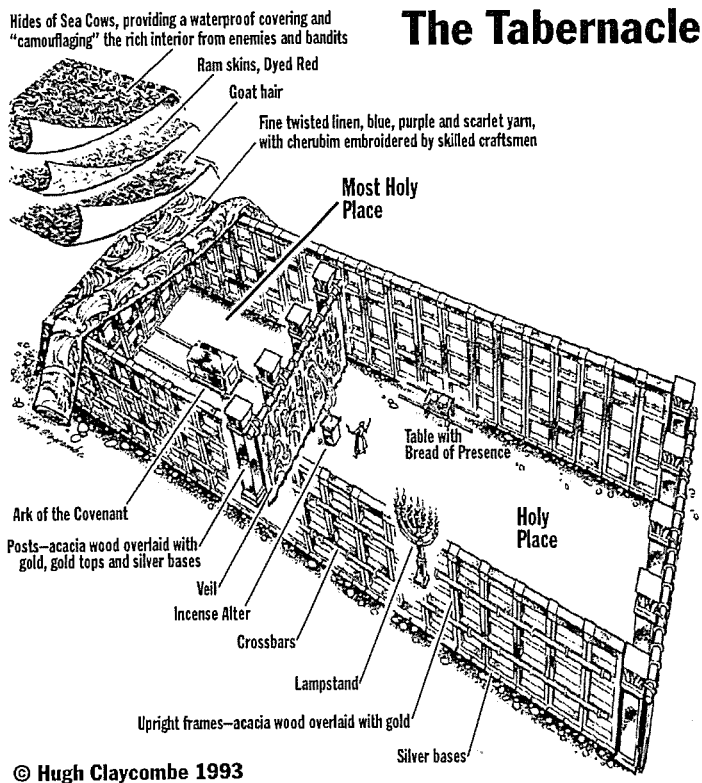

## The Bible and Blood

### A Quiz to Get You Thinking...

Without looking up the verses next to each of the statements below, please tick the following questions to show if you agree with the statement (A), are unsure whether you agree (U), or disagree with the statement (D).

A   U   D

1.            Blood is primarily a symbol of life in the Bible (Gen. 9:4; Deut. 12:23; Lev. 17:11).
2.            Blood is primarily a symbol of death in the Bible (Lev. 1—3; Heb. 9:7, 12).
3.            There can be no forgiveness of sin apart from the shedding of blood (Heb. 9:22).
4.            One must give his own blood for sin or have a substitute.
5.            It is alright to drink blood today since Christians are not under the law (Gen. 9:4; Lev. 17:10-12; Acts 15:29).
6.            Because blood is sacred, it should never be accepted in a transfusion.
7.            Accepting Christ's blood shed for us means we will go to heaven for sure.

### Old Testament Teaching

Blood is frequently used as a synonym for life itself (Gen. 4:10; 9:4; Deut. 12:23; Lev. 17:11).

However, blood also figuratively refers to murder (Hab. 2:12; cf. Matt. 27:24). In the OT the word for blood "occurs 362 times of which 203 point to death by violence and 103 to sacrificial blood" (R. K. Harrison, "Blood," in *Zondervan Pictorial Encyclopedia of the Bible*, 1:627).

So what does blood really signify—life or death? It signifies death. Even the key passage which indicates that "the life of a creature is in the blood" (Lev. 17:11) notes that this life is given up in atonement for one's life.

But why make a big deal about all this? Isn't this irrelevant theological jargon the kind of thing that should only be taught at Bible College? Not at all. And the New Testament tells us why...

### New Testament Teaching

"The OT... indicates that atonement for human sin was obtained by the death of an acceptable substitute, rather than by its life, and this emphasis, which is basic to the Old Covenant, is carried over into the NT with specific reference to the work of Jesus Christ in the New Covenant" (ibid.).

The NT word for blood indicates violent death 25 times apart from the sacrifice of Christ and 12 times refers to the blood of sacrificial animals (Heb. 9:7, 12, etc.)—all refer to death rather than life (ibid.).

So how does all this relate to Christ's blood? Some today believe that "the blood of Christ" means little more than "the life of Christ presented." Actually, it refers to His death because...

1. Christ's blood provides atonement through his death as victim (Acts 20:28; Eph. 1:7)
2. Christ's blood makes us justified, or makes us righteous (Rom. 5:9).
3. Christ's blood brings peace between God and man (Col. 1:20).
4. Christ's blood cleanses our consciences so we will not continue to sin (Heb. 9:14).
5. Christ's blood gives us eternal redemption (Heb. 9:12). So praise God for your security!

# Old Testament Sacrifices

*The Bible Visual Resource Book, 29*

Leviticus

## Old Testament Sacrifices

NAME	OT REFERENCES	ELEMENTS	PURPOSE
<b>BURNT OFFERING</b>	Lev 1; 6:8-13; 8:18-21; 16:24	Bull, ram or male bird (dove or young pigeon for poor); wholly consumed; no defect	Voluntary act of worship; atonement for unintentional sin in general; expression of devotion, commitment and complete surrender to God
<b>GRAIN OFFERING</b>	Lev 2; 6:14-23	Grain, fine flour, olive oil, incense, baked bread (cakes or wafers), salt; no yeast or honey; accompanied burnt offering and fellowship offering (along with drink offering)	Voluntary act of worship; recognition of God's goodness and provisions; devotion to God
<b>FELLOWSHIP OFFERING</b>	Lev 3; 7:11-34	Any animal without defect from herd or flock; variety of breads	Voluntary act of worship; thanksgiving and fellowship (it included a communal meal)
<b>SIN OFFERING</b>	Lev 4:1-5:13; 6:24-30; 8:14-17; 16:3-22	<ol style="list-style-type: none"> <li>1. Young bull: for high priest and congregation</li> <li>2. Male goat: for leader</li> <li>3. Female goat or lamb: for common person</li> <li>4. Dove or pigeon: for the poor</li> <li>5. Tenth of an ephah of fine flour: for the very poor</li> </ol>	Mandatory atonement for specific unintentional sin; confession of sin; forgiveness of sin; cleansing from defilement
<b>GUILT OFFERING</b>	Lev 5:14-6:7; 7:1-6	Ram or lamb	Mandatory atonement for unintentional sin requiring restitution; cleansing from defilement; make restitution; pay 20% fine

When more than one kind of offering was presented (as in Nu 6:16, 17), the procedure was usually as follows: (1) sin offering or guilt offering, (2) burnt offering, (3) fellowship offering and grain offering (along with a drink offering). This sequence furnishes part of the spiritual significance of the sacrificial system. First, sin had to be

dealt with (sin offering or guilt offering). Second, the worshiper committed himself completely to God (burnt offering and grain offering). Third, fellowship or communion between the Lord, the priest and the worshiper (fellowship offering) was established. To state it another way, there were sacrifices of expiation

(sin offerings and guilt offerings), consecration (burnt offerings and grain offerings) and communion (fellowship offerings—these included vow offerings, thank offerings and freewill offerings).



# Rituals for Levitical Offerings

F. Duane Lindsey, "Leviticus," *The Bible Knowledge Commentary*, 1:168-69

Rituals for Levitical Offerings									
		DEDICATORY			COMMUNAL	EXPIATORY			
		BURNT	GRAIN	DRINK	FELLOWSHIP	SIN	GUILT		
REFERENCES		(Lev. 1:3-17; 6:8-13)	(Lev. 2; 6:14-23)	(Num. 15:1-10; Lev. 23)	(Lev. 3; 7:11-36)	(Lev. 4:1-5:13; 6:24-30)	(Lev. 5:14-6:7; 7:1-10)		
SACRIFICIAL RITUALS	Worshiper's Actions	PRESENTATION: Selection of Offering	Bull (1:3), male sheep (1:10), male goat (1:10), or dove or young pigeon (1:14)	Grain or barley could be prepared in one of five ways: 1. Basic flour with oil; incense mixed with the part burned on the altar 2. Oven-baked cakes/wafers mixed or served with oil 3. Griddle-baked cakes, with oil 4. Pan-baked cakes 5. If <i>firstfruits</i> : crushed heads of new grain	With a bull— $\frac{1}{2}$ hin With a ram— $\frac{1}{2}$ hin With a lamb— $\frac{1}{4}$ hin (Note: one hin = ca. 1 quart)	Bull, lamb, or goat, male or female (3:1, 6, 12) (In the freewill offering, minor imperfections were permitted in animal, 22:23)	1. Young bull (for priest or nation) 2. Male goat (for tribal leader) 3. Female goat or lamb (for layperson) 4. Dove, young pigeon (for poor person) 5. Flour ( $\frac{1}{10}$ ephah) (for very poor)	Usually a ram (a male lamb in the case of a cleansed leper or defiled Nazirite)	
		LAYING ON OF HANDS	1:4 (except for bird) (see under "Sin offering")			(3:2, 8, 13—see "Burnt offering")	Sinner's identification with animal or subsequent symbolic transfer of sin and legal transfer of guilt	Confession (Num. 5:7) apparently accompanied by laying on of hands	
		SLAYING OF ANIMAL	Done by worshiper except that a bird was killed by the priest (cf. 1:15)			At sanctuary entrance (see "Burnt offering")	1. At sanctuary entrance for priest/nation 2. North of altar for others (see "Burnt offering")	North of altar (Lev. 7:2)	
		PREPARATION OF OFFERING	Skinning, dismembering, washing (cf. 1:6, 12, 16-17)	Worshiper normally prepared it in advance. Priest separated a memorial portion for burning on the altar					
SACRIFICIAL RITUALS	Priest's Actions	MANIPULATION OF BLOOD	1. Blood caught in a bowl and splashed against sides of the altar (1:5, 11) 2. Bird's blood drained out on side of the altar (1:15)			Blood caught in a bowl and splashed against sides of the altar (3:2, 8, 13)	Ritual varied according to the position of the worshiper (but involved "sprinkling" rather than "splashing" of blood), the occasion of sacrifice, or the type of animal (e.g., different if a bird)	Blood caught in a bowl and splashed against the sides of the altar (7:2)	
		INCINERATION ON ALTAR	All the animal burned on the altar (1:8-9, 12-13, 15, 17)	Memorial portion burned on the altar by the priest (all was burnt if it was the priest's own offering)	Entire libation poured out to the Lord at the sanctuary (Num. 28:7)	Choice viscera (including "fat tail" of sheep) burned on altar	Choice viscera burned on the altar	Choice viscera burned on the altar	
		DISTRIBUTION OR DISPOSAL OF CARCASS	Priest's dues	Skin (7:8)	Accompanying burnt offering; the priest ate unburned portion		Breast of animal was to be "wave offering" and eaten by priests	Priest received carcass of offering by leader or layperson	Priest received carcass
			Worshiper's portion	None	Accompanying fellowship offering; the worshiper ate unburned portion, but a small portion went to the priest		Communal meal for the worshiper's family at proper time and place		
	Remainder	Bird's crop to ashpit (1:16)			Remainder burned	Carcass burned outside the camp for priest or nation			

# Special Sacrificial Rituals

F. Duane Lindsey, "Leviticus," *The Bible Knowledge Commentary*, 1:168-69

Special Sacrificial Rituals								
		DEDICATORY			COMMUNAL	EXPIATORY		
		BURNT	GRAIN	DRINK	FELLOWSHIP	SIN	GUILT	
SPECIAL RITUALS	Consecration	1. Of priests (Ex. 29; Lev. 8)	Ram			Ram for the ordination	Bull (special ritual)	
		2. Of temple (2 Chron. 29)	70 bulls, 100 rams, 200 male lambs			Numerous bulls, sheep, and goats	Seven bulls, seven rams, seven male lambs, seven male goats	
	Decor-se-cration	Fulfillment of Nazirite vow (Num. 6:14-17)	Year-old male lamb	Regular grain offering, special bread offering		Ram	Year-old ewe lamb	
	Purification rituals	1. Broken vow (Num. 6:9-12)	Dove and young pigeon				Dove and young pigeon	Year-old male lamb
		2. Cleansing of leper (Lev. 14:12-20)	Year-old male lamb (dove or pigeon for poor)	Grain offering			Year-old ewe lamb	Year-old male lamb (plus log of oil)
		3. Man (15:14-15) or woman with hemorrhage (15:29-30)	Dove or young pigeon				Dove or young pigeon	
		4. Woman after childbirth (12:6-8)	Year-old lamb (or dove or pigeon)				Dove or young pigeon	
	Other	1. Jealousy ritual (Num. 5:15-26)		1/10 ephah barley meal, no oil or incense (Note: one ephah = 1/2 bushel, ca. 8 quarts)				
		2. Priest's daily grain offering (Lev. 6:19-23)		1/10 ephah fine flour				
		3. Sin offering of very poor (5:11-13)					1/10 ephah fine flour (no oil or incense)	
	OCCASION	Voluntary worship; certain prescribed rituals and calendrical offerings	An auxiliary offering accompanying burnt and always accompanying fellowship offerings; could be sin offering for the very poor	An auxiliary offering normally accompanying burnt or fellowship offerings, but never with sin or guilt offering alone	THANK OFFERING: for unexpected deliverance or blessing already granted VOTIVE OFFERING: for blessing or deliverance granted in answer to prayer which had accompanying vow FREEWILL OFFERING: to express thankful devotion without regard to specific blessing	Unintentional sin against divine command by an individual or the entire nation	Misappropriation or denial of rightful due to God or man, normally assessable in monetary compensation	
	DISTINCTIVENESS	Wholly burned on the altar (Lev. 1:9)	As a nonbloody offering, it accompanied bloody offerings	Wine was probably a deliberate substitute for blood of pagan libations	Most parts eaten before the Lord by the worshiper (and his family)	(See "Occasion" above)	Sacrifice (see "Occasion" above) was usually accompanied by compensation plus fine to wronged party	
	OLD TESTAMENT THEOLOGICAL SIGNIFICANCE	Signified the worshiper's act of total dedication to God	Signified dedication of everyday life to God in recognition of His covenant mercies		The worshiper recognized the meat eaten as a token of God's covenant faithfulness	Provided atonement and forgiveness for specific unintentional sins where no restitution was involved	The ram was for expiation, accompanied by payment of restitution to the wronged party	
TYPOLOGY	Christ died as the Lamb of God in complete dedication to the accomplishment of God's will	Christ's perfect person is associated with His sacrificial death		Christ's death is the basis of fellowship with God and other believers	Christ died as a satisfactory substitutionary sacrifice to provide the forgiveness of sins	Christ's death atones for the damage or injury caused by sin		

## Why No Pork? (And Other Law Questions)

Egyptian doctors of Moses' time treated wood splinters in the skin with worm's blood and donkey dung. "Since dung is loaded with tetanus spores, it is little wonder that lockjaw took a heavy toll of splinter cases" (S. I. McMillen, *None of These Diseases* [Old Tappan, NJ: Revell, 1963], 9).

God gave many commands to Israel through Moses without explaining the reasons for them. Only in modern times have some of these reasons come to light. Yet He did promise Moses, "If you listen carefully to the voice of the LORD your God and do what is right in his eyes, if you pay attention to his commands and keep all his decrees, I will not bring on you any of the diseases I brought on the Egyptians, for I am the LORD, who heals you" (Exod. 15:26). Here are some examples:

Issue	Law Command	Reason
Why not eat pork, bacon, or ham?	"And the pig, though it has a split hoof completely divided, does not chew the cud; it is unclean for you. You must not eat their meat or touch their carcasses; they are unclean for you" (Lev. 11:7-8).	"The vast majority of the foods prohibited are those which (1) are more likely to carry disease in the arid climate of the Sinai desert and/or... Canaan; or (2) are... uneconomical to raise as food in the particular agrarian context...; or (3) are foods favored for religious sacrifice by groups whose practices the Israelites were not to copy... the food laws... kept Israel away from certain allergies [but] the main source of Israel's meat—lamb—is the least allergic of all major meats" (Fee & Stuart, <i>How to Read the Bible for All Its Worth</i> , 145).
Why require circumcision?	"You are to undergo circumcision, and it will be the sign of the covenant between me and you. For the generations to come every male among you who is eight days old must be circumcised, including those born in your household or bought with money from a foreigner — those who are not your offspring" (Gen. 17:11-12).	Modern studies show that wives with circumcised husbands have far less cervical cancer than those with uncircumcised husbands. Non-Jewesses are 8½ times more likely to have cervical cancer than Jewesses are since uncircumcised men can deposit cancer-producing <i>Smegma bacillus</i> bacteria in the uterus (McMillen, 17-19). Also, the <i>eighth</i> day of a boy's life has the highest levels of vitamin K and prothrombin for blood clotting (ibid, 20-21)!
What's wrong with mixing meat and milk?	"Do not cook a young goat in its mother's milk" (Deut. 14:21).	God prohibited this because: (1) it would have been engaging in the fertility cult practices of Canaanites (Fee & Stuart, 146) or (2) because calcium cannot be assimilated easily on a milk and meat diet, which weakens teeth and slows the healing of broken bones ( <i>US News &amp; World Report</i> , 28 May 1984).
"Lepers feel bad enough about their disease, so why isolate them?"	"The priest is to examine the sore on his skin... If the spot on his skin is white but does not appear to be more than skin deep and the hair in it has not turned white, the priest is to put the infected person in isolation for seven days ... As long as he has the infection he remains unclean. He must live alone; he must live outside the camp" (Lev. 13:3-4, 46).	Between the 6th-14th centuries leprosy killed hundreds of millions of Europeans. Some said this was because of eating hot food, pepper, garlic, or the meat of diseased hogs—or even a bad conjunction of the planets! The Black Death followed, killing 60 million (¼ of Europe). After the physicians had nearly given up, the Church suggested the scriptural quarantine of lepers, which finally stopped the dreadful plague (McMillen, 11-12).

## Contrasting Levites and Priests

	<b>Levites</b>	<b>Priests</b>
<i>Descendants of...</i>	<i>Levi</i>	<i>Aaron (also a descendant of Levi)</i>
<i>Population</i>	<i>Many (the larger group)</i>	<i>Few (a subset of the Levites, Josh. 21:4)</i>
<i>Role</i>	<i>Assisted priests (1 Chron. 23:28) and supervised religious activities permitted outside of the sanctuary: teaching (Deut. 33:10a), singing (1 Chron. 15:16-24), leading worship (1 Chron 16:4-6; 23:5), officials, administration, judges &amp; gatekeepers (1 Chron. 23:4-5)</i>	<i>Mediators between God and Israel whom David made into 24 divisions (1 Chron. 24:3-4), each which served two weeks annually so that their service would gradually move around the calendar (BKC, 1:613); taught God's Word (Mal. 2:7)</i>
<i>Sacrificial Role</i>	<i>Didn't offer sacrifices though they did offer incense (Deut. 33:10b)</i>	<i>Offered sacrifices (Deut. 33:10b)</i>
<i>Location of Homes</i>	<i>Extensive—in 35 cities throughout the tribes in the central, northern, and eastern parts of Israel (Josh. 21:5-8)</i>	<i>Limited to 13 cities in the southern territories of Judah, Simeon, and Benjamin which were near the temple (Josh. 21:4, 9-13)</i>

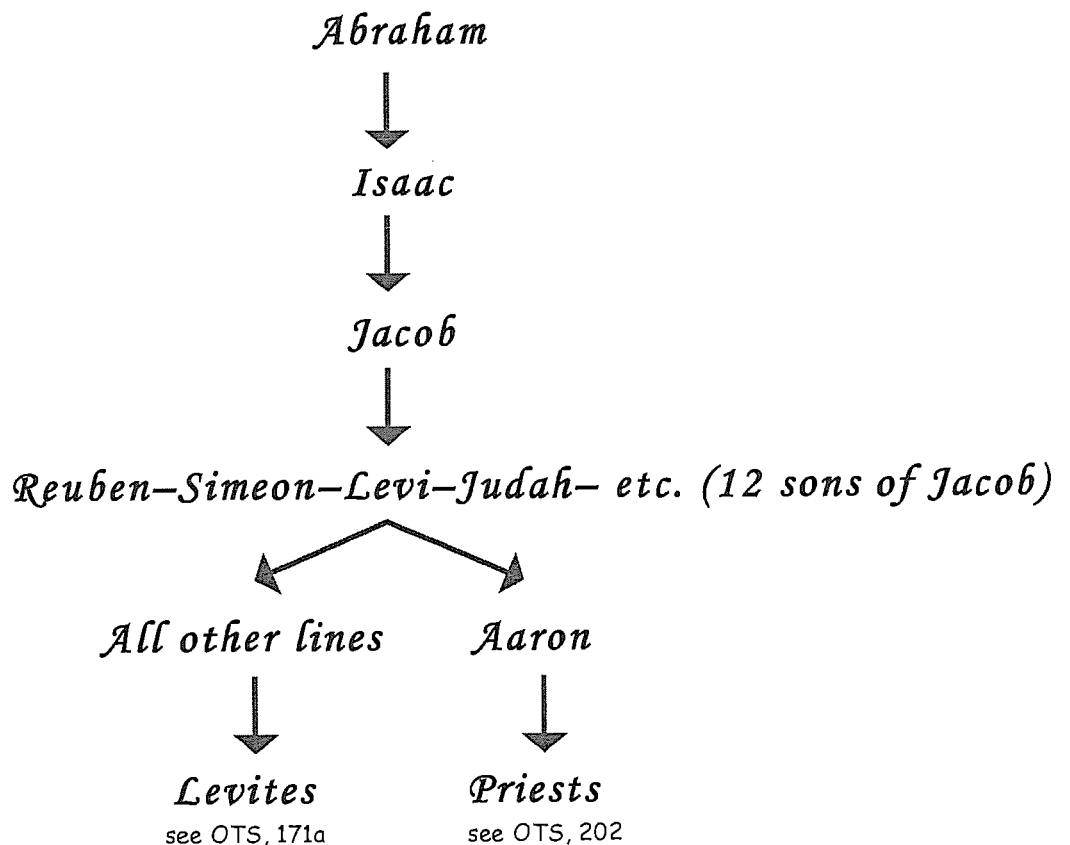

# Old Testament Feasts and Other Sacred Days

NAME	OT REFERENCES	OT TIME	MODERN EQUIVALENT	DESCRIPTION	PURPOSE	NT REFERENCES
Sabbath	Ex 20:8-11; 31:12-17; Lev 23:3; Dt 5:12-15	7th day	Same	Day of rest; no work	Rest for people and animals	Mt 12:1-14; 28:1; Lk 4:16; Jn 5:9; Ac 13:42; Col 2:16; Heb 4:1-11
Sabbath Year	Ex 23:10-11; Lev 25:1-7	7th year	Same	Year of rest; fallow fields	Rest for land	
Year of Jubilee	Lev 25:8-55; 27:17-24; Nu 36:4	50th year	Same	Canceled debts; liberation of slaves and indentured servants; land returned to original family owners	Help for poor; stabilize society	
Passover	Ex 12:1-14; Lev 23:5; Nu 9:1-14; 28:16; Dt 16:1-3a, 4b-7	1st month (Abib) 14	Mar.-Apr.	Slaying and eating a lamb, together with bitter herbs and bread made without yeast, in every household	Remember Israel's deliverance from Egypt	Mt 26:17; Mk 14:12-26; Jn 2:13; 11:55; 1Co 5:7; Heb 11:28
Unleavened Bread	Ex 12:15-20; 13:3-10; 23:15; 34:18; Lev 23:6-8; Nu 28:17-25; Dt 16:3b, 4a, 8	1st month (Abib) 15-21	Mar.-Apr.	Eating bread made without yeast; holding several assemblies; making designated offerings	Remember how the Lord brought the Israelites out of Egypt in haste	Mk 14:1, 12; Ac 12:3; 1Co 5:6-8
Firstfruits	Lev 23:9-14	1st month (Abib) 16	Mar.-Apr.	Presenting a sheaf of the first of the barley harvest as a wave offering; making a burnt offering and a grain offering	Recognize the Lord's bounty in the land	Ro 8:23; 1Co 15:20-23
Weeks (Pentecost) (Harvest)	Ex 23:16a; 34:22a; Lev 23:15-21; Nu 28:26-31; Dt 16:9-12	3rd month (Sivan) 6	May-June	A festival of joy; mandatory and voluntary offerings, including the firstfruits of the wheat harvest	Show joy and thankfulness for the Lord's blessing of harvest	Ac 2:1-4; 20:16; 1Co 16:8
Trumpets (Later: Rosh Hashanah—New Year's Day)	Lev 23:23-25; Nu 29:1-6	7th month (Tishri) 1	Sept.-Oct.	An assembly on a day of rest commemorated with trumpet blasts and sacrifices	Present Israel before the Lord for his favor	
Day of Atonement (Yom Kippur)	Lev 16; 23:26-32; Nu 29:7-11	7th month (Tishri) 10	Sept.-Oct.	A day of rest, fasting and sacrifices of atonement for priests and people and atonement for the tabernacle and altar	Cleanse priests and people from their sins and purify the Holy Place	Ro 3:24-26; Heb 9:7; 10:3, 19-22
Tabernacles (Booths) (Ingathering)	Ex 23:16b; 34:22b; Lev 23:33-36a, 39-43; Nu 29:12-34; Dt 16:13-15; Zec 14:16-19	7th month (Tishri) 15-21	Sept.-Oct.	A week of celebration for the harvest; living in booths and offering sacrifices	Memorialize the journey from Egypt to Canaan; give thanks for the productivity of Canaan	Jn 7:2, 37
Sacred Assembly	Lev 23:36b; Nu 29:35-38	7th month (Tishri) 22	Sept.-Oct.	A day of convocation, rest and offering sacrifices	Commemorate the closing of the cycle of feasts	
Purim	Est 9:18-32	12th month (Adar) 14, 15	Feb.-Mar.	A day of joy and feasting and giving presents	Remind the Israelites of their national deliverance in the time of Esther	

On Kislev 25 (mid-December) Hanukkah, the feast of dedication or festival of lights, commemorated the purification of the temple and altar in the Maccabean period (165/4 B.C.). This feast is mentioned in Jn 10:22.

© 1989 by Gospel Light Publications. Permission granted to purchaser to reproduce this Sheet for class purposes only.

## Eschatology of Israel's Feasts (Lev. 23)

	<u>Date</u>	<u>Length</u>	<u>Feast</u>	<u>Significance (Past)</u>	<u>Typology (Future)</u>
1.	Weekly	1 day	Sabbath* (Shabbat)	Reminder of: • Creation rest of God • Deliverance from Egypt Sign of Mosaic Covenant (Exod. 20, 31; Deut 5)	Millennial rest (Heb. 4:1-11)
2.	1-14 (Nisan)	1 day (Read Song of Songs)	Passover*† (Pesach)	Redemption from Egypt by blood of the sacrificial lamb (Exod. 12)	Redemption from sin by Christ's death as Lamb (1 Cor. 5:7b)
3.	1-15 to 1-21 (Nisan)	7 days	Unleavened Bread*†	Separation/break from dependence upon Egypt to dependence upon God	Separated life of the redeemed for God (1 Cor. 5:7a, 8)
4.	1-16 (Day after Harvest Sabbath)	1 day	Firstfruits (barley sheaf ceremony)	Anticipation of God's <i>future</i> material provisions -begins grain harvest	Resurrection of Christ (1 Cor. 15:20)
5.	3-6 (Sivan)	1 day (Read Ruth)	Pentecost† (Shavuoth) (Weeks) (Harvest)	Thanksgiving for God's <i>past</i> material provisions -ends grain harvest (Deut. 16:9-12)	Coming of the Holy Spirit to complete Christ's resurrection (Acts 2)
—	Spring-Summer	no feasts	—	Enjoyment of the harvest	Church Age
6.	7-1 (Tishri)	1 day	Trumpets (New Year) (Rosh Hashanah)	Preparation for national redemption and cleansing on Day of Atonement	Rapture (1 Thess. 4:13f.) Revelation (Matt. 24:31) —Kingdom preparation
7.	7-10 (Tishri)	1 day	Day of Atonement (Yom Kippur)	National repentance and cleansing from sins of the people (Lev. 16)	National repentance of Israel in the Tribulation (Rom. 11:26-27)
8.	7-15 to 7-21 (Tishri)	7 days (Read Eccles.)	Tabernacles*† (Booths/Tents) (Succot) (the Lord) (Ingathering)	Anticipated fulfillment of the Abrahamic Covenant (Neh. 8)	Actual fulfillment of the Abrahamic Covenant —Kingdom (Matt. 17:4)
9.	7-22 (Tishri)	1 day	Shemini Atzeret (Simchat Torah)	“8th Day of Assembly” “Rejoicing in the Torah”	

The following days are not commanded in Scripture and probably have no eschatological significance:

10.	5-9 (Ab)	1 day (Read Lam.)	9th of Ab (Tish'ah be'ab)	Destructions of Jerusalem: 586 BC & AD 70	↑
11.	9-25 (Kislev)	1 day + 7 more days of candle lighting	Hanukkah (Dedication) (Lights) (Illumination) (Maccabees)	Saving of the nation under Judas Maccabeus in 164 BC (cf. John 10:22)	<i>This Typology column shows that the order of Israel's annual feasts prophetically parallels her experience as a nation throughout history!</i>
12.	12-14/15 (Adar)	2 days (Read Esther)	Purim (Lots)	Saving of the nation under Esther (9:21)	

\* Feasts celebrated in the Millennium (Isa. 66:23; Ezek. 45:21; 46:1; Zech. 14:16-19)

† Feasts celebrated in three annual Jerusalem pilgrimages by all male Israelites (Exod. 23:14-17)

<b>LEVITICUS</b>	<b>NUMBERS</b>
<p>Worship</p> <p>Position</p> <p>Ceremonial</p> <p>Priests</p> <p>Access to God</p> <p>Purity</p> <p>People's privileges</p> <p>Faithfulness to God</p>	<p>Walk</p> <p>Progress</p> <p>Historical</p> <p>Levites</p> <p>Service for men</p> <p>Pilgrimage</p> <p>People's responsibilities</p> <p>Fellowship with God</p>

# Numbers

<b>Preparation to Occupy the Land</b>									
Preparing the Old Generation		Postponement for Unbelief					Preparing the New Generation		
1:1–10:10		10:11–25:18					26–36		
God’s Faithfulness		Israel’s Faithlessness					God’s Faithfulness		
God’s Blessings		God’s Discipline					God’s Blessings		
Israel’s Commitment		Israel’s Complaining					Israel’s Commitment		
Order		Disorder					Reorder		
Mount Sinai		Wilderness					Moab		
20 Days		38 Years, 3 Months, 10 Days					ca. 5 Months		
Organization (1–4)	Sanctification (5:1–10:10)	To Kadesh (10:11–12:16)	Kadesh Sin (13–14)	Wilderness (15–19)	To Moab (20–21)	Moab Sin (22–25)	Provision for Land (26–27)	Offerings & Vows (28–30)	Final Preparations (31–36)

**Key Word:** Preparation

**Key Verses:** *Discipline*—“Not one of the men who saw my glory and the miraculous signs I performed in Egypt and in the desert but who disobeyed me these ten times—not one of them will ever see the land I promised on oath to their forefathers...” (Numbers 14:22-23)

*Blessing*—“God is not a man, that he should lie, nor a son of man, that he should change his mind. Does he speak and then not act? Does he promise and not fulfill? I have received a command to bless; he has blessed, and I cannot change it” (Numbers 23:19-20)

**Summary Statement:**

God's faithful preparation of His people to enter Canaan contrasts with Israel's unbelieving rebelliousness in the wilderness to teach the nation His unconditional commitment to fulfill His Abrahamic Covenant but only through a believing generation.

**Applications:**

We as believers need to realize that God has given us everything we need to do His will, but disobedience deserves discipline.

God will get His will done either through us or in spite of us.

Are we characterized by commitment or complaining?



# Numbers

## Introduction

I. **Title** The Book of Numbers takes its name from two censuses of Israel about thirty-eight years apart. The first census was of the Exodus generation at Mount Sinai (ch. 1) and the second recorded the new generation on the plains of Moab that was born in the wilderness and later conquered Canaan (ch. 26). The Hebrew title is "And He Said," taken from the first word of the book (אָמַר Wayyedabber). However, Jewish writings generally refer to the writing as "In the Wilderness," derived from the fifth word of 1:1 (בְּמִדְבָּר *B<sup>e</sup>midbar*).

## II. Authorship

- A. **External Evidence:** Ancient Jewish, Samaritan, and Christian testimony uniformly claims that Moses authored the Book of Numbers.
- B. **Internal Evidence:** Numbers states "the LORD spoke to Moses" more than eighty times, the first being in 1:1. However, even more specific reference to his authorship is made in this clear statement: "Now Moses wrote down the starting points of their journeys at the command of the LORD" (33:2; cf. 36:13). The book also evidences a consistency of style characteristic of a single author. Nevertheless, most critical scholars deny Mosaic authorship based upon the varying linguistic forms within the work (e.g., LaSor, 165).

## III. Circumstances

- A. **Date:** Mosaic authorship places the writing in his lifetime (1525-1405 BC). The tabernacle was set up exactly one year after the Exodus (Exod. 40:17) and the Book of Numbers picks up the story one month later (Num. 1:1). Therefore, the time covered by Numbers begins one year after the Exodus (in 1444 BC) and covers the thirty-eight year and nine month (Num. 10:11; Deut. 1:3; cf. LaSor, 163) wilderness wandering until just before the conquest of Canaan (beginning ca. 1405 BC). Moses probably kept a journal of the wanderings and compiled them shortly before his death in ca. 1405 BC.
- B. **Recipients:** Moses did not enter Canaan so the first readers were the Jews in the wilderness.
- C. **Occasion:** The nation had been redeemed from Egypt and has constructed the tabernacle (Exodus), had been instructed in holy living (Leviticus), and undoubtedly thought it was ready to possess the land. However, God knew that Israel was not ready (cf. Exod. 13:17) without additional preparation, so He organized the people for conquest (1:1—10:10). However, their unbelief prevented them from entering Canaan (10:11—25:18).

## IV. Characteristics

- A. Numbers is the book of the wilderness wanderings. Exodus records the short journey from Egypt to Sinai, but Numbers chronicles the nearly 40 year wilderness journey.
- B. Numbers provides more census data about preexilic Israel than any Old Testament book.
- C. Twice in the New Testament (1 Cor. 10:1-12; Heb. 3:7—4:6) Numbers illustrates truths.

## Argument

While Leviticus relates to the nation's worship, Numbers records the nation's walk. Specifically, Numbers records how God prepared Israel to walk with Him in a covenant relationship (1:1—10:10) but the nation postponed the fulfillment of the promise of the land through unbelief, so God purged it of its rebellion (10:11—25:18). Nevertheless, due to God's faithfulness to His covenant, the next generation of Jews was again prepared for entrance into the land (chs. 26—36). The narrative continually contrasts God's faithfulness with Israel's faithlessness.

## Synthesis

### Preparation to occupy the land

(God's faithfulness vs. Israel's faithlessness)

#### 1:1–10:10

#### Preparing the old generation

1–4	Travel organization
1–2	Census/camp/march
3–4	Levite responsibilities
5:1–10:10	Sanctifying Israel
5–6	Separation
7:1–9:14	Worship
9:15–10:10	Divine guidance

#### 10:11–25:18

#### Postponement for unbelief

10:11–12:16	To Kadesh
10:11-36	Leave Sinai
11	Quail
12:1-15	Miriam/Aaron oppose
12:16	Paran
13–14	Kadesh: Climactic unbelief
15–19	Wilderness
15	Offering/death penalty review
16	Korah
17–19	Priests-rod, roles, heifer
20–21	To Moab
20	Rock water
21	Sihon, Og, bronze snake
22–25	Moab
22–24	Balaam/Barak
25	Beth Peor

#### 26–36

#### Preparing the new generation

26–27	Provision for land
26	New census
27:1-11	New inheritance law
27:12-23	New leader–Joshua
28–30	Offerings/vows
31–36	Final preparations
31–32	Transjordan conquered
33:1-49	Wanderings summarized
33:50–36:13	Canaan defined (boundaries, Lev./refuge cities, new inherit. law)

## Outline

### Summary Statement for the Book

God's faithful preparation of His people to enter Canaan contrasts with Israel's unbelieving rebelliousness in the wilderness to teach the nation His unconditional commitment to fulfill His Abrahamic Covenant but only through a believing generation.

- I. (1:1–10:10) God prepares the camp of the old generation to enter Canaan as an orderly and sanctified nation to teach Israel His faithfulness to His Abrahamic Covenant (20 days at Mount Sinai).
  - A. (Chs. 1–4) God organizes Israel's old generation of people and Levites for efficient travel through the wilderness in preparation for the conquest of the land.
    1. (Chs. 1–2) God organizes the people through an army census, camp arrangement, and marching order as His preparation to defeat the Canaanites.

- a. (Ch. 1) The first census in Israel numbers 603,550 soldiers to demonstrate God's faithful provision of an army for the nation to defeat the Canaanites.
  - b. (Ch. 2) The camp arrangement and marching order affirms God's desire for orderliness with His people.
  2. (Chs. 3—4) God organizes the Levites for the care and transportation of the tabernacle and redeems them for lifelong service that Israel would treat His holy things respectfully.
    - a. (3:1-39) God gives the three Levite clans responsibility to care for the tabernacle so that Israel would treat the holy things with utmost respect.
    - b. (3:40-51) God substitutes Levites for the firstborn sons as compensation for sparing the firstborn Israelites at the Exodus to provide lifelong servants for the tabernacle.
    - c. (Ch. 4) God assigns the moving of the tabernacle to the three Levite clans so that His holy things would be transported in an orderly manner.
- B. (5:1—10:10) God sanctifies Israel through separation, worship, and His own guiding presence that the nation might enter Canaan as a holy nation.
1. (Chs. 5—6) Various laws of sanctification by separation are given to preserve the physical, social, spiritual, and marital purity of the camp.
    - a. (5:1-4) Make ceremonially unclean persons to live outside the camp to protect the *physical* purity of Israel.
    - b. (5:5-10) Recompense for financial wrongdoing to protect the *social* purity of Israel.
    - c. (5:11-31) Test women suspected of adultery to protect the *marital* purity of Israel.
    - d. (6:1-21) Separate Nazarites to protect the *spiritual* purity of Israel.
    - e. (6:22-27) The priestly blessing formula is provided that God might separate Israelites as His own unique people.
  2. (7:1—9:14) Israel's sanctification through worship is prescribed that the nation might give God the honor due His holy name.
    - a. (Ch. 7) The leaders offer gifts from each of their tribes at the tabernacle dedication as an expression of sanctified worship to give God the honor due His holy name.
    - b. (8:1-4) The arrangement of the lighted lamps is given to show Israel additional formerly unrevealed information about its worship.
    - c. (8:5-26) The Levites' consecration provides divine approval for the worship of Israel.
    - d. (9:1-14) Passover celebration is allowed for those ceremonially unclean at Passover but it must be done exactly one month later than the regular date and in the prescribed manner to encourage Israel to worship God in holiness.
  3. (9:15—10:10) Israel's sanctification through God's guidance in the tabernacle cloud and assembly trumpets assures His presence so the nation might enter Canaan as a holy nation.
    - a. (9:15-23) God guides Israel through the tabernacle cloud that the people might be sanctified by the assurance of His presence and dependence upon Him for direction.
    - b. (10:1-10) God commands the making and use of two trumpets for assemblage, battle victory, and feasts as a memorial of His guiding presence.

**II. (10:11—25:18) God judges unbelief in the old generation by forbidding entrance into the land to rid the nation of the rebellious while still faithfully leading it to Canaan (38 years, 3 months, 10 days in the wilderness).**

- A. (10:11—12:16) Israel's unbelief en route to Kadesh by complaining over manna and opposing Moses' leadership is judged by God to affirm His just yet faithful guiding to Canaan.
1. (10:11-36) Israel leaves Sinai at the command of the LORD as evidence of the nation's initial trust in God's guidance.
  2. (Ch. 11) God provides quail for the people when they complain about the manna but judges them with plagues for their rebelliousness to teach His grace balanced with justice.
  3. (12:1-15) God judges the envious opposition to Moses by Miriam and Aaron by making Miriam leprous temporarily to show His approval of Moses' leadership.
  4. (12:16) Israel leaves Hazereth (north of Sinai at the edge of the Desert of Paran) and camps in the Desert of Paran to move itself closer to the Promised Land.
- B. (Chs. 13—14) God judges Israel's ultimate failure at Kadesh (the nation's unbelief in Joshua and Caleb's faith to conquer Canaan) by forbidding entrance into the land to teach that His rest can be claimed only by faith.
- C. (Chs. 15—19) Israel's unbelief in the wilderness by resisting Moses and Aaron is met with God's judgments and instructions regarding the priesthood to promote a respect for leaders and an understanding of covenantal obligations for God's continued presence.
1. (Ch. 15) A review of the offerings for thanksgiving and unintentional sins and an account of the death penalty for intentional sin is provided for the young Israelites to understand the requirements of their covenantal relationship with God.
  2. (Ch. 16) God kills Korah, Dathan, Abiram, and On with their families, 250 men, and 14,700 Israelites for opposing Moses and Aaron to convey to Israel the necessity of obeying God's appointed leaders.
  3. (Chs. 17—19) Instructions regarding the priests are provided to remind Israel of its responsibility to obey and pay God's workers to maintain their purity required for God's continued presence among the nation.
    - a. (Ch. 17) God vindicates Aaron by making his rod bud before the rebellious people who just had challenged his authority to provide a lasting memorial of the necessity of obeying His appointed leaders.
    - b. (Ch. 18) The roles and remunerations of the priests and Levites are cited to remind jealous Levites that the priesthood resides only with Aaron's descendants and to remind Israel as a whole of its responsibility to care for God's workers.
    - c. (Ch. 19) Priests must use the ashes from a sacrificed red heifer mixed into the water of cleansing for ceremonial purification from corpses to maintain ritual cleanness in the nation required for God's presence to abide with the people.
- D. (Chs. 20—21) Israel's unbelief en route to Moab is met with death by God balanced with His gracious preservation in the defeat of Transjordan nations to enable the nation to continue toward its Promised Land.
1. (Ch. 20) In the journey in the Desert of Zin, Moses and Aaron receive God's denial of Canaan entrance at the water from the rock incident, Miriam and Aaron die, and Edom refuses passage to Israel, all being judgments for unbelief in the nation.

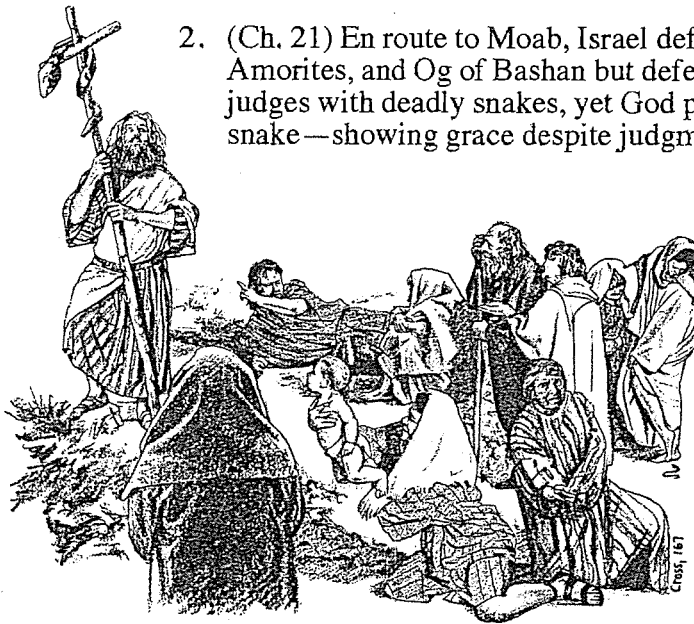

2. (Ch. 21) En route to Moab, Israel defeats the Canaanites, Sihon of the Amorites, and Og of Bashan but defeat themselves by grumbling which God judges with deadly snakes, yet God provides relief through a bronze snake—showing grace despite judgment.

- E. (Chs. 22—25) Israel's unbelief at Moab through sexual idolatry with Moabite prostitutes meets God's severe judgment while the nation experiences undeserved blessing by God.
1. (Chs. 22—24) Balak (king of Moab) fails to turn God against Israel when he hires the pagan prophet Balaam of Beor to curse Israel, but Balaam blesses the nation instead to show God's unconditional though undeserved commitment to His people.
  2. (Ch. 25) At Baal of Peor Balak succeeds in turning Israel against God through Moabite prostitutes whose seduction into immorality and idolatry kills 24,000 by plague before Phinehas atones for Israel's sin to declare God's hatred of defiant sin.

### III.(Chs. 26—36) God prepares the believing new generation to enter Canaan through a reorganization, sanctification by reviewing the offerings and vows, and definition of the boundaries of Canaan (5 months on the plains of Moab).

- A. (Chs. 26—27) God makes provision for the new generation to inherit the land by reorganizing the nation through a new census, new law of inheritance, and new leader.
1. (Ch. 26) Israel's second census shows the new generation of 601,730 is barely smaller than the old generation 38 years earlier—God's provision of soldiers to defeat Canaan.

### Population Changes in the Wilderness

Tribes	Numbers 1 (1444 BC) Start of Wanderings	Numbers 26 (1406 BC) End of Wanderings	Increase (Decrease)
Reuben	46,500	43,730	(2,770)
Simeon	59,300	22,200	(37,100)
Gad	45,650	40,500	(5,150)
Judah	74,600	76,500	1,900
Isaachar	54,400	64,300	9,900
Zebulun	57,400	60,500	3,100
Ephraim	40,500	32,500	(8,000)
Manasseh	32,200	52,700	20,500
Benjamin	35,400	45,600	10,200
Dan	62,700	64,400	1,700
Asher	41,500	53,400	11,900
Naphtali	53,400	45,400	(8,000)
<b>Total</b>	<b>603,550</b>	<b>601,730</b>	<b>(1,820)</b>

These numbers only include men 20 years old or older who served in the army (26:2, 4). Women, children, Levites and the handicapped were not counted. Assuming each soldier had a wife and an average of only one child puts the total population nearly 2 million. The tribe of Reuben decreased partly due to rebelling with Korah (26:8-9; cf. 16:1-35). The tribe of Simeon shrank the most, perhaps due to the plague that killed 14,700 (16:49) and/or the tribe's immorality at Beth Peor, which killed 24,000 (25:9), as its leader Zimri was a Simeonite (25:14).

2. (27:1-11) Inheritance is given to the daughters of Zelophehad, a man who died without sons, showing God's gracious provision for those who would otherwise have no inheritance.
  3. (27:12-23) Joshua's commissioning to succeed Moses is God's provision of a leader for the new generation.
- B. (Chs. 28–30) God reviews the regulations concerning offerings and vows to sanctify and thus enable the new generation to worship Him appropriately.
1. (Chs. 28–29) Regulations regarding offerings for daily, weekly, monthly, and yearly sacrifices are provided that the new generation might worship God appropriately.
  2. (Ch. 30) Regulations regarding women's vows are given to show the importance of keeping vows made to God that the new generation might worship God appropriately.
- C. (Chs. 31–36) The Transjordan is conquered, God's faithful guidance throughout the wilderness is summarized, and lands both east and west of the Jordan are defined as final preparations for Israel's entrance into the land.
1. (Chs. 31–32) The defeat of the land east of the Jordan (Transjordan) is completed with the destruction of the Midianites according to God's will and defined according to man's will to teach that God's inheritance is always best.
    - a. (Ch. 31) Israel defeats the Midianites and divides the spoil for turning Israel away from the LORD at Peor, thus demonstrating God's jealous love for His people.
    - b. (Ch. 32) The eastern (Transjordan) tribes of Reuben, Gad, and Manasseh half-tribe receive their requested inheritance provided they fight in Canaan and forfeit their inheritance in Canaan to teach that God's inheritance is always best.
  2. (33:1-49) A summary of Israel's journey from Egypt to Moab is given to promote the people's trust in God for the many experiences in which He led them to prepare them for entrance into the land.
  3. (33:50–36:13) The land west of the Jordan (Canaan) is defined in boundaries, Levite towns, and cities of refuge, then prevented by statute from mixed tribal areas to prepare Israel for entrance into the land.
    - a. (33:50–34:29) The Western tribes are promised their inheritance in Canaan, provided they drive out the inhabitants, to teach Israel that God's gifts involve human responsibility as preparation for entrance into the land.
    - b. (Ch. 35) Forty-eight cities in Canaan are granted to the Levites, which include six cities of refuge for fugitives of unintentional murders to protect God's name from slander (either by neglect of His servants or by slaying innocent lives).
    - c. (Ch. 36) Moses commands that all daughters who inherit land must marry within their father's tribal clan so that every Israelite will possess the inheritance of his fathers, thus preventing the mixing of lands within a tribal area.

## The Number of Israelites in the Wilderness

Can we take the censuses in Numbers 1 and Numbers 26 at face value? Such high numbers seem incredible today, for they argue for a population about half of Israel's modern day population of 7.4 million (2009 estimate that excludes the non-Israeli population in the West Bank and Gaza Strip).

### I. **The Problem:** Some believe that Israel's 603,550 soldiers (Num. 1:46) with a total population of 2-3 million (including women and children) is too large for several reasons:

- A. Recent estimates postulate the entire population of Canaan to be 500,000 people, so their soldiers would be far less than that number. So what was Israel worried about if they had over 600,000 warriors to fight about 200,000 or so Canaanites?
- B. Recent studies declare that the entire population of Egypt was probably only 2 million. How could Israel have had a population greater than all of Egypt?
- C. The Egyptian army is believed by some scholars to have been only about 25,000 men. Would such a small army really chase after the Israelites who were many times their size?
- D. Egypt's army had only 600 chariots—not a real threat against 600,000 Israelite soldiers.
- E. "How could millions of people have gotten organized, maintained their cohesion, and traveled through deserts, frequently on narrow routes and difficult terrain? The answer does not lie in... text corruption, for the large figures prevail throughout the accounts."<sup>1</sup>

### II. **Suggested Solutions:** Some scholars believe that the problem is not the text itself but how it has been translated. At least three new translation attempts have been made:

- A. *Clan Hypothesis:* 'Elep means "thousand" but it can also mean "clan" (e.g., Gideon's 'elep was Israel's smallest clan, Jud. 6:15), so the census counted clans totaling 5,100 men :

One suggestion is that 'elep, translated "thousand," should be understood as a social unit such as a clan or family (cf. Jud. 6:15; 1 Sam. 10:19; Micah 5:2; etc.). This then might be a technical term suggesting a much smaller actual number. In such a case the total for Reuben, for example (Num. 1:20-21), would be 46 clans plus 500 individuals rather than 46,500. If Reuben's clans were 100 men, his total would be 4,600 plus 500 non-clan individuals or 5,100 in all.<sup>2</sup>

- B. *Chief Hypothesis:* 'Elep has the wrong vowels and refers to a word with *other* vowels, meaning about 600 army "chiefs" plus their men, totaling 6,148 men (cf. Appendix 1):

A second suggestion is that 'elep in an unvocalized Hebrew text could be read 'allûp, "chief" or "commander." Then in Reuben's case the number would be 46 'allûps plus 500 men. The grand total would be 598 'allûps plus 5,550 men.<sup>3</sup>

- C. *Unit Hypothesis:* 'Elep can also refer to an army "unit," such as the unit that received ten cheeses from Jesse, David's father (1 Sam. 17:18). Such a small number of cheeses would not feed many within a thousand-man unit, so it is likely a much smaller number.

<sup>1</sup> Cited by Eugene H. Merrill, "Numbers," in *The Bible Knowledge Commentary: An Exposition of the Scriptures*, eds. John F. Walvoord and Roy B. Zuck (Wheaton, IL: Victor Books, 1983-c1985), 1:217.

<sup>2</sup> Ibid.

<sup>3</sup> Ibid.

- D. The first two views result in the 603,550 men being as small as 65,350 or 6,148 men, or, in the “unit hypothesis,” an unknown but much smaller total, depending on each unit size.

### III. Why should we take the 603,550 fighting men at face value (Num. 1:46)?

#### A. Numerical Considerations (correlate numbers 1-5 with A-E on previous page)

1. If we assume Canaan to have as high as 200,000 warriors, there is still reason for both sides to be worried. The people of Canaan knew about the miraculous crossing of Israelites out of Egypt (cf. Rahab in Joshua 2:8-11), so they would surely be worried to face over 600,000 Israelite warriors! Israel also worried over the giants within Canaan (Num. 13:32-33). Further, the Amalekites had already defeated them, even though Israel did defeat the Amorites on the east side of the Jordan.
2. If we assume that Egypt's entire population was 2 million, it makes more sense for them to be afraid of 3 million Israelites in Goshen than it does for them to fear a tiny and powerless people among them. After all, the Pharaoh specifically said, “the Israelites have become much too numerous for us. <sup>10</sup>Come, we must deal shrewdly with them or they will become even more numerous” (Exod. 1:9b-10a NIV). An army of a few thousand would pose no threat to the Egyptians.
3. If we assume an Egyptian army of 25,000 men, certainly the whole army did not mobilize to chase Israel. Even if the whole army did chase them, they would not fear being outnumbered 3 to 1 given that their Israelite foes were not trained for warfare. They had been slaves for hundreds of years and only gained freedom a few days prior.
4. More likely is that only Egypt's army of 600 chariots faced Israel at the Sea without any of their foot soldiers. However, even this small contingent could do significant damage against half a million Israelite soldiers. Even if it could not defeat them, we must not assume that Pharaoh was acting rationally to attack, which is out of character with his hardened heart prior to the Exodus. He was also grieving the death of his firstborn son when he chased after Israel.
5. Whether millions of Israelites could have “gotten organized, maintained their cohesion, and traveled through deserts, frequently on narrow routes and difficult terrain” assumes that God could not have miraculously worked on their behalf. Also, they were already organized by tribe and had been tempered by 400 years of slavery.
6. The Hebrew number of 603,500 is written out in prose as “six hundred thousand, five hundred and fifty” without any qualifiers (such as clans or chiefs) and thus must be taken at face value.
7. The parallel text in Exodus 12:37 has the approximate number of “about 600,000 men” and thus argues for the number in Numbers 1:46 as a real number.
8. The earliest translation of this number was the Septuagint (250 BC), which rendered it with the equivalent Greek number of 603,550.
9. Every single English translation renders the number as an actual number rather than an approximate amount far smaller. Therefore, the alternate theories do not pass peer review among other OT scholars who translated the NAS, NIV, RSV, ESV, etc.



### B. The Clan Hypothesis

1. The number of supposed “clans” for each tribe totals not 603 but 598 “clans,” plus 5,550 individuals. See Appendix 1.

The major objection to this view is that the grand total for the tribes is 603,550 which, by this system, would mean 603 clans plus 550 individual men. When all the **clans** of the tribes are added up, however, they come to a total of 598 plus 5,550 individuals. This cannot be harmonized with the biblical figures.<sup>4</sup>

2. One should wonder why miscellaneous individuals who were not in one of the tribal clans would need to be added to each tribe. If they are deemed to be part of the “mixed multitude” added to each tribe, it is unlikely that these would also be enlisted as soldiers.

### C. The Chief Hypothesis

1. Seeing the number as counting chiefs has the same addition problem as the clan idea. If the numbers in the thousands place (i.e., the “46” in the 46,500 Reubenites in Numbers 1:21) actually designate *chiefs* rather than *thousands of warriors*, then the total of 598 chiefs also does not square with the 603 total. See Appendix 1.
2. Why would the text list the number of chiefs only with a miscellaneous number of individuals? This would leave out the main component—the number of fighting men—and leave only the number of chiefs plus the rabble. While readers could assume a certain number of warriors per chief, such approximation seems out of character with the concept of conducting an actual census of soldiers.
3. If the actual Israelite population numbered only about 6000 soldiers, the concern of the Egyptians that they were becoming so numerous that the baby boys would have to be killed at birth would be ridiculous (Exod. 1:16, 22; cf. vv. 9-10).

### D. The Unit Hypothesis

1. David gave ten cheeses to his brother’s “commander of *their* thousand” (1 Sam. 17:18 NASB), but there is no assumption that these would feed the *entire* thousand men.
2. We know from 1 Samuel 17:18 that the commander of the unit where Jesse’s sons served had control over 1000 men—not 100 men. Assuming that 46 chiefs who each had 1000 men in their “unit” gives us the same figure for Reuben: 46 men over 1000, or 46,000 men. So what’s the difference between the “unit” theory and taking the number 46,500 at face value?

## IV. Conclusion

The recent studies that doubt the translation of about 600,000 Israelite soldiers in Exodus 12 and Numbers 1 and 26 are not convincing. There exists no textual problems in any of these passages, and each of the alternate translations of this number is fraught with even more problems. Until better evidence is forthcoming, interpreters can consider the text reliable as it has consistently come down to us and appears in all of our translations.

<sup>4</sup> Ibid.

*Appendix 1*  
*Views on Israel's Population in the Wilderness (Num. 1)*

Tribe	Traditional View	Clan Hypothesis	Chief Hypothesis
Reuben	46,500	46 clans of 100 = 4600 + 500 men = 5,100	46 chiefs + 500 men = 596
Simeon	59,300	59 clans of 100 = 5900 + 300 men = 6,200	59 chiefs + 300 men = 359
Gad	45,650	45 clans of 100 = 4500 + 650 men = 5,150	45 chiefs + 650 men = 695
Judah	74,600	74 clans of 100 = 7400 + 600 men = 8,000	74 chiefs + 600 men = 674
Isaachar	54,400	54 clans of 100 = 5400 + 400 men = 5,800	54 chiefs + 400 men = 454
Zebulun	57,400	57 clans of 100 = 5700 + 400 men = 6,100	57 chiefs + 400 men = 457
Ephraim	40,500	40 clans of 100 = 4000 + 500 men = 4,500	40 chiefs + 500 men = 450
Manasseh	32,200	32 clans of 100 = 3200 + 200 men = 3,400	32 chiefs + 200 men = 232
Benjamin	35,400	35 clans of 100 = 3500 + 400 men = 3,900	35 chiefs + 900 men = 935
Dan	62,700	62 clans of 100 = 6200 + 700 men = 6,900	62 chiefs + 700 men = 762
Asher	41,500	41 clans of 100 = 4100 + 500 men = 4,600	41 chiefs + 500 men = 541
Naphtali	53,400	53 clans of 100 = 5300 + 400 men = 5,700	53 chiefs + 400 men = 453
Total	603,550	598 clans of 100 = 59,800 + 5,550 men = 65,350	598 chiefs + 5550 men = 6,148

Note that the total number of clans is 598, which does not match the explicit reading of the Numbers 1:46 text that says this number is 603. The Chief Hypothesis repeats the same error. Certainly the Hebrews could do basic addition, which strongly argues that the number 603,550 refers to actual persons in the hundreds of thousands—not to the number of clans or chiefs. As noted earlier, the Unit Hypothesis renders 46 units as 46 units of a thousand (cf. 1 Sam. 17:18), yielding the same number as the Traditional View.

# Encampment of the Tribes of Israel and Cities of Refuge

*The Bible Visual Resource Book, 35*

Numbers

## Encampment of the Tribes of Israel

Numbers 2:1-31; 10:11-33

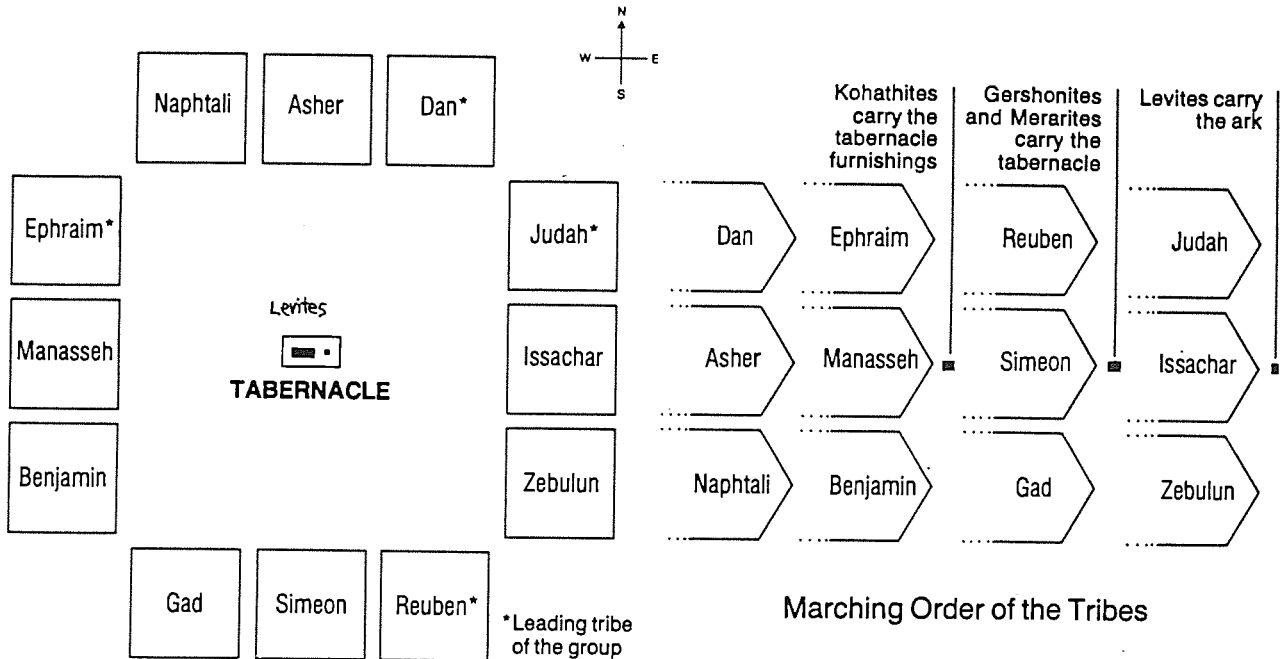

## Cities of Refuge

Numbers 35:6-34; Joshua 20:1-9 (cf. p. 17/a)

The idea of providing cities of refuge (Jos 20:1-9) for capital offenses is rooted in the tension between customary tribal law (retaliation or revenge, in which the blood relative is obligated to execute vengeance) and civil law (carried out less personally by an assembly according to a standard code of justice).

Blood feuds are usually associated with nomadic groups; legal procedures, with villages and towns. Israel, a society in the process of sedentarization, found it necessary to adopt an intermediate step regulating manslaughter, so that an innocent person would not be killed before standing trial. Absolution was possible only by being cleared by his hometown assembly, and by the eventual death of the high priest, which freed the offender from ritual pollution.

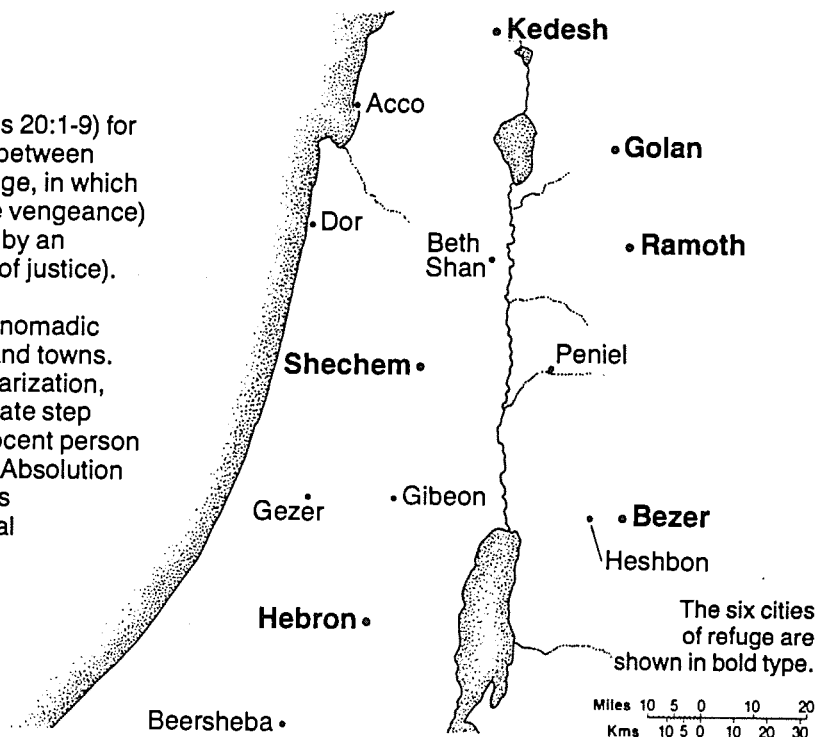

# Journey of the Spies

Barry Beitzel, *The Moody Atlas of Bible Lands*, 93

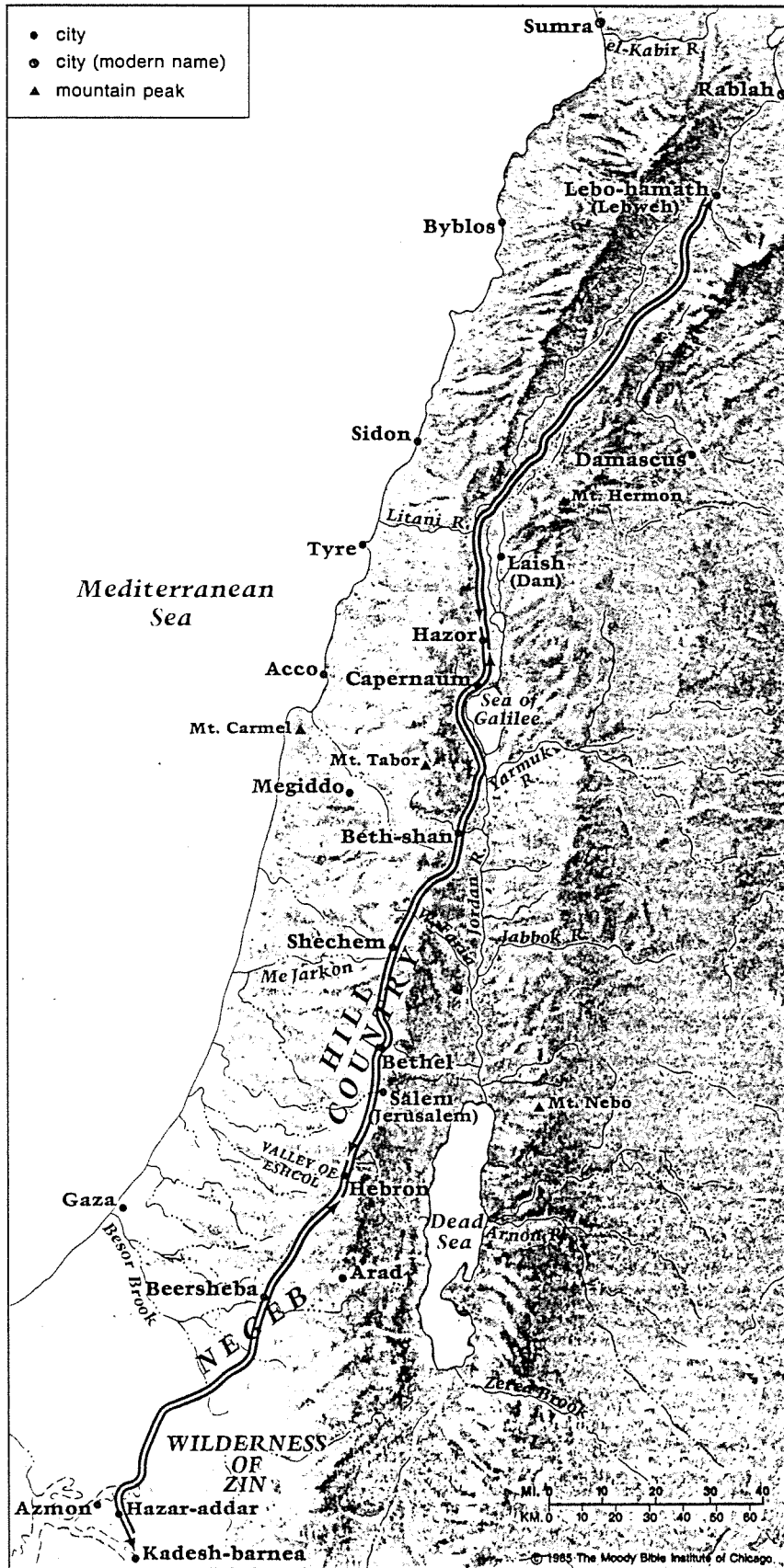

## Israel's Early Eastern Neighbors

John H. Walton, *Chronological and Background Charts of the OT*, 2d ed., 71

Period	EDOM	MOAB	AMMON	AMALEK
<b>FATHER</b>	Esau: son of Isaac	Moab: son of Lot and his eldest daughter	Ben-Ammi: son of Lot and his second daughter	Amalek: son of Eliphaz, who was a son of Esau
<b>EXODUS</b>	The country was controlled to some degree by Amorites. Refused passage to the Israelites (Num. 20:14-21)	The country was conquered by Sihon and the Amorites (Num. 21:26)  King Balak feared Israel and sought the services of Balaam to curse them (Num. 22)		Defeated by the Israelites at Rephidim (Exod. 17:8-16)  Defeated the Israelites at Hormah following report of the spies (Num. 14:45)
<b>JUDGES</b>	c. 1350 Continued under the partial control of the Amorites (Judg. 1:35-36)	c. 1350 King Eglon oppressed Israel for 18 years  Ehud delivered Israel by assassinating Eglon (Judg. 3:12-30)	c. 1350 Ally of Eglon of Moab  c. 1100 B.C. Oppressed Israel for 18 years. Defeated by Jephthah (Judg. 10-12)	c. 1350 Ally of Eglon of Moab
<b>UNITED MONARCHY</b>	c. 1030 Saul took some cities from Edomite territory (1 Sam. 14:47)  c. 1000 Conquered and subjugated by David (1 Chron. 18:12)	c. 1030 Saul took some cities from Moabite territory (1 Sam. 14:47)  c. 1000 Conquered and subjugated by David (2 Sam. 8:2)	c. 1050 Nahash defeated by Saul at Jabesh-gilead (1 Sam. 11:1-11)  c. 1030 Saul took some cities from Ammonite territory (1 Sam. 14:47)  c. 990 Hanun defeated by David; Rabbah captured; Ammon subjugated (2 Sam. 12:26-31)	c. 1020 Agag defeated by Saul in southwest Palestine. Saul failed to destroy Amalek totally as the Lord had commanded (1 Sam. 15:1-9)  c. 1010 Destroyed David's camp at Ziklag while he was gone. David pursued and wiped them out. This is last mention of them (1 Sam. 30)

See locations on p. 181

## Israel's Early Western Neighbors

John H. Walton, *Chronological and Background Charts of the OT*, 2d ed., 73

	PHOENICIA	PHILISTIA
ORIGIN	Semitic Amorites	Aegean Sea people
PRE-JUDGES	c. 1500 Territory was divided between Hittite and Egyptian domination	Not yet in Palestine
JUDGES	<p>1400—Began slow rebellion, first against Egypt</p> <p>1380-1287—Mostly controlled by Hittites; control diminished until 1190</p> <p>1190—Invasion by sea peoples. Independent city-states established</p> <p>1100—Some control exercised by Tiglath-pileser I</p>	<p>1190—Defeated Hittites, destroyed capital. Defeated by Rameses III, settled on coast of Palestine. Five major cities: Gath, Gaza, Ashkelon, Ashdod, Ekron</p> <p>11th cent—Controlled parts of at least Dan and Judah (Judg. 14:4; 15:11). Samson held somewhat in control</p> <p>1060—Overran Israel; captured ark (1 Sam. 4)</p> <p>1050—Israel subdued Philistia at Ebenezer (1 Sam. 7:7-14)</p>
SAUL	Political independence; cultural development	Philistines held in check through most of this period. They were defeated at Michmash by Jonathan and at Elah through David. Overran country at end after defeating and killing Saul at Mt. Gilboa
1000-900 B.C.	Golden Age 981-942—Hiram I of Tyre; alliance with Israel. Expansion of sea trade and exploration; colonies in N. Africa, Spain, Asia Minor, and Mediterranean	David defeated and subdued the Philistines (2 Sam. 5:17-25)
900-722 B.C.	<p>890—High Priest Ethbaal gains throne. Alliance with Israel continues with marriage of his daughter Jezebel to Ahab</p> <p>865—Paid tribute to Assyria—Ashur-nasir-pal II</p> <p>853—Joined 12-nation alliance against Shalmaneser III at Qarqar</p> <p>841—Shalmaneser III takes some cities. Assyrian tributary through end of period</p>	<p>Paid tribute to Jehoshaphat (2 Chron. 17:11)</p> <p>Raided Judah during the reign of Jehoram (2 Chron. 21:16-17)</p> <p>805—Assyrian Adad-nirari III collected tribute; subjugated by Uzziah but invaded Judah during reign of Ahaz (2 Chron. 28:18); subdued by Tiglath-pileser III of Assyria</p>
722-570 B.C.	<p>725—During reign of Shalmaneser V, Luli of Sidon tried to unite Phoenicia in revolt</p> <p>701—Sennacherib responded by invasion—many cities taken, deportation, puppet ruler</p> <p>677—Revolt crushed by Esarhaddon—Sidon destroyed</p> <p>665—Baalit of Tyre revolted—suppressed by Ashurbanipal</p> <p>584-571—Nebuchadnezzar besieged &amp; took Tyre</p>	<p style="text-align: center;">Country subjugated and Gaza captured by Hezekiah (2 Kings 18:8)</p> <p>People captured and deported by Nebuchadnezzar</p>

## Broken People

Henry Blackaby (1 of 2)

### **PROUD, UNBROKEN PEOPLE**

### **BROKEN PEOPLE**

Keep people at arms' length

Risk getting close to others/willing to take the risks of loving intimately

Quick to blame others

Accept personal responsibility -- can see where *they* were wrong

Unapproachable

"Easy to be entreated"

Defensive when criticized

Receive criticism with a humble, open heart

Concerned with being "respectable"

Concerned with being real

Concerned about what others think

All that matters is what God knows

Work to maintain image/protect reputation

Die to own reputation

Find it difficult to share their spiritual needs with others

Willing to be open/transparent with others

Want to be sure nobody finds out about their sin

Willing to be exposed (Once broken, you don't care who knows--nothing to lose!)

Have a hard time saying, "I was wrong; will you please forgive me?"

Are quick to admit failure and to seek forgiveness

When confessing sin, deal in generalities

Deal in specifics

Concerned about the consequences of their sins

Grieved over the cause/root of their sins

Remorseful over their sin -- got caught/ found out

Repentant over sin (forsake it)

When there is a misunderstanding or conflict, wait for the other to come and ask forgiveness

Take the initiative to be reconciled; see if they can get to the cross first!

Compare themselves with others and feel deserving of honor

Compare themselves to the holiness of God and feel desperate need for mercy

Blind to their true heart condition

Walk in the light

Don't think they have anything to repent of

Continual heart attitude of repentance

Don't think they need revival (think everybody else does!)

Continually sense their need for a fresh encounter with the filling of His Spirit

**Broken People**  
Henry Blackaby (2 of 2)

**PROUD, UNBROKEN  
PEOPLE**

**BROKEN PEOPLE**

---

Focus on the failures of others	Overwhelmed with sense of their own spiritual need
Self-righteous; have a critical, fault-finding spirit; look at own life/faults through a telescope but others with a microscope	Compassionate; forgiving; look for the best in others
Look down on others	Esteem all others better than self
Independent/self-sufficient spirit	Dependent spirit/recognize need for others
Maintain control; must be <i>my</i> way	Surrender control
Have to prove that they are right	Willing to yield the right to be right!
Claim rights	Yield rights
Demanding spirit	Giving spirit
Self-protective of time, rights, reputation	Self-dënying
Desire to be served	Motivated to serve others
Desire to be a success	Desire to be faithful to make others a success
Desire for self-advancement	Desire to promote others
Driven to be recognized/appreciated	Sense of unworthiness; thrilled to be used at all; eager for others to get credit
Wounded when others are promoted and they are overlooked	Rejoice when others are lifted up
"The ministry is privileged to have me!"	"I don't deserve to serve in this ministry!"
Think of what they can do for God	Know that they have nothing to offer God
Feel confident in how much they know	Humbled by how much they have to learn
Self-conscious	Not concerned with self at all



# Deuteronomy

<b>Renewal of the Mosaic Covenant</b>					
Past		Present	Future		
Examples		Laws	Challenges		
What God has Done		What God Expects	What God will Do		
Historical		Legal	Prophetic		
Preamble	Historical Prologue	Stipulations	Blessings and Curses	Covenant Renewal	Leadership Transition
1:1-4	1:5-4:43	4:44-26:19	27-28	29-30	31-34
Introduction	Sermon #1	Sermon #2	Sermon #3	Sermon #4	Sermons
<b>Plains of Moab</b>					
<b>About 1 Month</b>					

**Key Word:** Renewal

**Key Verse:** “Hear, O Israel: The LORD our God, the LORD is one. Love the LORD your God with all your heart and with all your soul and with all your strength” (Deuteronomy 6:4-5)

**Summary Statement:**

Moses preaches and records sermons which expound the Law in order to encourage Israel's new generation in renewal of the covenant at Sinai, resulting in blessing in Canaan for obedience, not cursing for disobedience.

**Applications:**

True obedience is based on love—not legalism.

God’s general rule is that blessing results from obedience but problems result from disobedience.

# Deuteronomy

## Introduction

**I. Title** Deuteronomy means "second law" (Greek: δεύτερος, *second*, and νόμος, *law*). This is a confusing title as the book actually adapts and expands upon the original law given on Mount Sinai. This English title stems from the Septuagint mistranslation of Deuteronomy 17:18 as "this repetition of the Law" (correctly rendered "this copy of the Law" in English translations). The Hebrew title is "These Are The Words" (אֵלֶּה הַדְּבָרִים 'elleh hadd<sup>e</sup>barim) from the first two words according to ancient methods of titling a work. This is a better title since the book records Moses' sermons that expound the Law (1:5).

## II. Authorship

A. External Evidence: The ancient Jewish, Samaritan, and Christian testimonies uniformly attribute the authorship of Deuteronomy to Moses. Other Old Testament passages refer to the entire Pentateuch as Mosaic (cf. Josh. 1:7; Judg. 3:4; 1 Kings 2:3; etc.). Christ Himself considered the book authoritative (though did not specifically mention Mosaic authorship) in His quotations of Deuteronomy during His temptation (cf. Matt. 4:4, 7, 10 with Deut. 8:3; 6:16, 13, respectively).

B. Internal Evidence: The Mosaic authorship of Deuteronomy has been held almost universally by both Jews and Christians until the rise of the 19th century liberal critics. They don't know who wrote it, but they still assume this cannot be Moses for four reasons (Deere, *BKC*, 1:259-260):

1. These liberals believe the "book of the Law" found 800 years after Moses in Josiah's reign was a "pious forgery" of Deuteronomy written in Josiah's era (2 Chron. 34:14ff.).

Response: No one knows the identity of the "book of the Law" (whether it actually was Deuteronomy, the entire Pentateuch, or a portion of either) and the production of "pious frauds" is virtually unknown in the Near East as well as unethical (and an oxymoron). The structure of the book also fits the time of Moses, not Josiah (see under "Characteristics" below).

2. They claim the book commands a central sanctuary (12:1-14) at Jerusalem to combat the worship at the "high places" in Israel's later history.

Response: The book does not claim that Jerusalem is this central sanctuary, but rather cites Mount Ebal (27:1-8). This would be a significant oversight for a forger seeking to motivate Israel to replace the high places for true worship in Jerusalem.

3. Some material is post-Mosaic (2:10-12, 20-23; 3:13b-14; chap. 34).

Response: It is true that these are later additions but this does not provide convincing evidence that Moses did not record the bulk of the book. Neither is inspired editorial activity incompatible with the doctrine of inspiration.

4. It contains accurate predictions concerning Israel's exile and regathering (4:25-31; 28:20-68; 29:22-28; 30:1-10; 32:23-43).

Response: Its reveals an anti-supernatural bias by saying even God cannot know the future!

How else do we know Moses wrote it? The book claims Moses wrote it over forty times (31:24-26; cf. 1:1-5; 4:44-46; 29:1; 31:9). It also views Canaan from the outside, assumes hearers recall the wilderness, shows Israel living in tents, has firsthand knowledge of geography and historical details, and follows the suzerain treaty form of the fifteenth and fourteenth centuries (*TTB*, 37-38).

### III. Circumstances

- A. Date: Moses died before Israel entered the Promised Land (Deut. 34) in 1405 BC. The Book of Deuteronomy records his last words to the nation in this strategic year.
- B. Recipients: The original readers comprised the new generation of Jews in Moab with Moses who heard him preach the sermons recorded in Deuteronomy.
- C. Occasion: The nation had been elected by God (Genesis), redeemed from Egypt with a completed tabernacle (Exodus), instructed for a month in holy living (Leviticus), and prepared for possession of the land through forty years in the wilderness (Numbers). At this point the new generation was poised for subduing the land, having arrived at the plains of Moab just across from the Jordan River. Seeing his imminent death and the strategic time in the nation's history, Moses preached several significant sermons, then wrote them down to encourage Israel to love, believe, and obey God in order to receive His blessings. That this generation needed this renewal of the covenant is evident in their major failure in immorality at Beth Peor just a short time earlier (cf. Num. 25).

### IV. Characteristics

- A. Deuteronomy is one of the most influential books in the Old Testament with many quotations by the prophets and a notable number of manuscripts at Qumran. It is one of the Old Testament books most quoted in the New Testament (e.g., Matt. 4) with 49 quotations. This is exceeded only by more references to Psalms (119 times) and Isaiah (100 times). Of the 27 New Testament writings, 11 of them quote the book of Deuteronomy.
- B. Deuteronomy possesses the famous *Shema* ("Hear") which states, "Hear, O Israel: The LORD our God, the LORD is one" (6:4). This simple declaration is the greatest doctrinal statement in the Old Testament, Judaism's basic confession of faith, the potent affirmation of monotheism and the declaration of God's uniqueness among the pantheon of Near Eastern "gods." It is probably the clearest statement of the Trinity in the Pentateuch since "God" (*'elohim*) is plural but "one" (*'ehad*) may suggest a unity of Persons in the Godhead (cf. Gen. 2:24, where *'ehad* is used of Adam and Eve being "one flesh").
- C. This final book of Moses also includes the greatest commandment—that Israel should love the LORD with totality of heart, soul, and strength (6:5). Love for God and obedience to God find their greatest marriage here of all books of the Pentateuch, but the emphasis is on the former: the word "obey" occurs ten times whereas "love" appears twenty-two times. The love of God towards Israel and His people's response of love back towards Him pervades the entire book.
- D. This writing also is the first to mention the Great Tribulation (4:29-31).
- E. The test for determining true and false prophets is found only in Deuteronomy (18:20-22).
- F. Deuteronomy delineates the Land Covenant more than any book of Scripture (chs. 29–30). This covenant promises full occupation of Canaan only after exile and repentance.
- G. The structure of Deuteronomy is unique in Scripture as it follows a similar, though not identical, pattern of the fifteenth century international vassal treaty. When a king (the suzerain) made a treaty with a subject country (vassal) the treaty generally included the following six elements, many of which find parallel in Deuteronomy (Deere, *BKC*, 1:260; LaSor, 144-146, 176):

<u>Element</u>	<u>Explanation</u>	<u>Parallel in Deuteronomy</u>
1. Preamble	Introduction to the treaty	Introduction: Historical Setting/Moses as Covenant Mediator (1:1-4)

2. Historical Prologue	History of the king's dealings with the vassal	Sermon #1: Historical Prologue (1:5—4:43)
3. General Stipulation	Call for wholehearted allegiance to the king	Sermon #2: Covenant Obligations (4:44—11:32)
4. Specific Stipulations	Detailed laws required of vassal to show allegiance	Sermon #2 cont'd: Specific Laws (Chs. 12—26)
5. Divine Witnesses	Deities called to witness the treaty	Heaven and earth witness since no deities exist (4:26; 30:19; 31:28; 32:1)
6. Blessings and Curses	Results for obeying or disobeying the treaty	Sermon #3: Blessings and Curses (Chs. 27—28)
		Sermon #4: Covenant Summary (Chs. 29—30)
		Narrative/Sermons: Transition of the Covenant Mediator from Moses to Joshua (Chs. 31—34)

Although chapters 29—34 do not follow the suzerain-vassal format, nevertheless certain parallels exist even in this section (Deere, *BKC*, 1:316): depositing of the treaty document in a sacred place (31:24-26), provision for dynastic succession (31:7-8), and provision for future reading of the covenant and other covenant ceremonies (31:9-13).

## Argument

As already indicated above, Deuteronomy follows the suzerain-vassal treaty format common in its time. In this book, the LORD (the suzerain) uses Moses as His covenant mediator to guide the new generation of Israel (the vassal) into a renewal of the Mosaic Covenant made with the former generation which died in the desert. After the introduction (1:1-4), this covenant renewal is accomplished by reminding Israel of what the LORD had already done for the nation (1:5—4:43). Moses then expounds upon the stipulations to which Israel as the vassal must agree for the renewal to be instituted (4:44—26:19), and the results of both obeying or defaulting upon the covenant (chs. 27—28). The final appeal for obedience (chs. 29—30) is followed by the transition from Moses to Joshua as the covenant mediator (chs. 31—34) since the final chapter records Moses' death. In each section Moses appeals to the nation to choose to obey the covenant.

## Synthesis

### Renewal of the covenant

<b>1:1-4</b>	<b>Preamble: Setting/Mediator</b>
<b>1:5—4:43</b>	<b>#1: Historical Prologue</b>
1:5—3:29	God's faithfulness: Sinai to Beth Peor
4:1-43	Obedience exhorted
<b>4:44—26:19</b>	<b>#2: Stipulations</b>
4:44—5:33	Decalogue—General obligation
6—11	Loving the LORD—General principle
6:1-9	Shema declared
6:10—11:32	Shema expounded
12:1—26:15	Specific Laws—Allegiance
12:1—16:17	Ceremonial
16:18—20:20	Civil
21:1—26:15	Social
26:16-19	Covenant ratified

<b>27 — 28</b>	<b>#3: Blessings and Curses</b>	
27	Palestinian renewal ceremony commanded	
28	Blessings/Curses of Mosaic Covenant	
<b>29 — 30</b>	<b>#4: Covenant Summary</b>	
29	Obedience exhorted	
30:1-10	Palestinian Covenant—ultimate blessings	
30:11-20	Choose life/death	
<b>31 — 34</b>	<b>Leadership Transition</b>	
31:1-29	Appointment	31
31:30—32:43	Song	32
32:44—34:12	Death/replacement	
32:44-52	Address	
33	Blessing	33
34	Death	34

## Outline

### Summary Statement for the Book

**Moses preaches and records sermons which expound the Law in order to encourage Israel's new generation in renewal of the covenant at Sinai, resulting in blessing in Canaan for obedience, not cursing for disobedience.**

- I. (1:1-4) Preamble: The historical setting of Moses' sermons is the desert east of Canaan after the new generation has conquered the Transjordan and before it possesses Canaan, which provides the context for the Palestinian Covenant.**
  - A. (1:1) The content of the Book of Deuteronomy is cited as what Moses, the covenant mediator, speaks to Israel's new generation opposite the Jordan to provide the context for the Palestinian Covenant.
  - B. (1:2-4) The time of the Book of Deuteronomy is after the Transjordan conquests in the final month (cf. 34:8) of the forty year wilderness wanderings which should have taken eleven days—a clear expression of the cost of disobeying God.
- II. (1:5—4:43) Historical Prologue: Moses' first sermon provides an historical review of God's deliverance and provision when the people obeyed and judgment when they rebelled to exhort them to obey the Law and resist idolatry.**
  - A. (1:5—3:29) Moses reviews God's acts for Israel from Sinai to Beth Peor to remind the people of His deliverance and provision when they obeyed and judgment when they rebelled.
  - B. (4:1-43) Moses exhorts the people to obey the Law and resist idolatry on the basis of God's benevolent acts on their behalf.
- III. (4:44—26:19) Stipulations: Moses' second sermon delineates the general covenant obligations and specific laws that God expects of the nation to encourage Israel to show total allegiance to the LORD as King.**
  - A. (4:44—5:33) The Ten Commandments are repeated for the new generation as their general covenant obligation because of their need for a review of God's stipulations due to their own defection at Beth Peor.
    1. (4:44-49) An introduction to the Ten Commandments reminds the new generation that they need to hear them afresh due to their sin of idolatry and intermarriage at Beth Peor approximately five months before (cf. Num. 25:1-3).

2. (Ch. 5) The Ten Commandments spoken by God to the people at Mount Sinai are repeated as the general covenant obligation for the new generation of Israel to follow.
- B. (Chs. 6—11) Moses expounds upon the basic principle of loving the LORD through basic commands and warnings to encourage Israel to total allegiance to the LORD as King.
1. (6:1-9) Moses commands the basic principle in the *Shema*—to love the LORD—by thanking Him for a land not deserved and by teaching the Law to their children so that Israel might experience blessings of land, long life, and material prosperity.
    - a. (6:1-3) Israel is promised blessings of land, long life, and material prosperity as incentive to obey the covenant.
    - b. (6:4-9) The command to love the LORD (the *Shema*) and its importance is expressed as the basis for obeying all stipulations in the covenant.
  2. (6:10—11:32) Moses expounds upon how to love the LORD through basic commands and warnings to encourage Israel to total allegiance to the LORD as King.
    - a. (6:10-19) Thanking God for a land not deserved so as not to acquire a sense of independence shows love for the LORD.
    - b. (6:20-25) Teaching the Law to one's children so that this love might continue in future generations shows love for the LORD.
    - c. (Ch. 7) Totally conquering Canaan so that no rival may exist to God's Lordship shows love for the LORD.
    - d. (Ch. 8) Remembering God's provision in the wilderness so that the land's abundance will not promote a spirit of self-sufficiency shows love for the LORD.
    - e. (9:1—10:11) Avoiding self-righteousness by remembering God's mercy at the golden calf failure shows love for the LORD.
    - f. (10:12—11:32) The concluding exhortation on loving the LORD provides four reasons to love Him: Israel's election, His powerful deeds, success, and longevity in the land depend upon obedience from love, and the option is a curse!
- C. (12:1—26:15) Moses expounds upon selected specific laws in the ceremonial, civil, and social dimensions which Israel agrees to obey in total allegiance to the LORD as King.
1. (12:1—16:17) Ceremonial laws encourage Israel to total allegiance to the LORD as King.
    - a. (12:1-28) A single, central sanctuary is commanded as the sole place of worship to prevent Israel from sacrificing on the Canaanite worship centers, which the nation must destroy.
    - b. (12:29—13:18) Idolatry must be repressed by the destruction of false prophets, family members, friends, towns, and any other influence towards pagan practices.
    - c. (14:1-21) Unclean food must not be eaten since it symbolizes evil in the human realm to teach Israel its unique relationship to God among the nations.
    - d. (14:22-29) Tithes must be given for the Levites and poor as an evidence of total allegiance to the LORD, who can make up for money dedicated to Him.
    - e. (15:1-18) Debts must be canceled and slaves set free every seventh year as evidence of a generous heart towards God and man.

- f. (15:19-23) Firstborn animals must be given to God as evidence of total allegiance to the LORD, who can make up for animals dedicated to Him.
  - g. (16:1-17) Celebration of the three great annual Feasts of Passover/Unleavened Bread, Weeks, and Tabernacles is commanded for Israel to corporately acknowledge the LORD as Deliverer and Provider.
2. (16:18—20:20) Civil laws are expounded to encourage Israel to total allegiance to the LORD as King.
- a. (16:18—18:22) Administrators appointed to maintain justice must be just themselves.
    - 1) (16:18—17:13) Judges and officials must be impartial and not accept bribes, and the verdict of the law courts must stand.
    - 2) (17:14-20) Kings must avoid materialism and write their own personal copy of this law so they will follow God humbly.
    - 3) (18:1-8) Priests and Levites must live on the support of the people so that Israel will express allegiance to the LORD through sacrificial giving.
    - 4) (18:9-22) Prophets must avoid detestable practices and be 100% accurate to avoid the death penalty.
  - b. (Ch. 19) Criminal laws must provide cities of refuge, punish those who steal property through moving boundary markers, and fit judgments to the crime only on the basis of at least two witnesses.
  - c. (Ch. 20) Holy war laws dictate fearlessness before Israel's enemies, exemption for certain men from military service, offering peace before a siege, and a prohibition from the destruction of fruit trees.
3. (21:1—26:15) Social laws are expounded to encourage Israel to total allegiance to the LORD as King.
- a. (21:1-9) Atonement for an unsolved murder is prescribed so as to purge the land of the guilt of shedding innocent blood.
  - b. (21:10-21) Family laws prescribe the proper procedure for marrying a captive woman, giving the rights to the firstborn son, and killing a rebellious son, to hold Israel accountable for family rights.
  - c. (21:22—22:12) Various social laws are expounded to encourage Israel to total allegiance to the LORD as King.
  - d. (22:13-30) Marriage violations in sexual matters such as dissatisfaction, rape, and adultery are condemned to uphold the marital vow and premarital purity.
  - e. (23:1-8) Exclusion from the assembly is required of emasculated and certain foreign individuals so Israel could worship purely.
  - f. (23:9-14) Laws of nocturnal emission and proper means of disposing excrement are delineated to prevent uncleanness in the camp for God's abiding presence.
  - g. (23:15—25:19) Miscellaneous social laws, especially those concerning finances and divorce and remarriage, confirm God's will that the nation demonstrate total allegiance to the LORD.

h. (26:1-15) Ceremonial ritual for the presentation of firstfruits and tithes prescribe how Israelites can indicate thankfulness and allegiance to the LORD.

D. (26:16-19) Israel and God ratify the covenant by both vowing to fulfill their respective commitments in the covenant as a binding conditional suzerain-vassal treaty.

**IV. (Chs. 27—28) Moses' third sermon commands renewal of the covenant and pronounces blessings for obedience and curses for disobedience to motivate obedience to the covenant.**

A. (Ch. 27) Moses commands that Israel renew the covenant in Palestine to reinforce the official responsibilities to which the nation was committing itself in the covenant.

1. (27:1-8) Moses commands the proper ceremony for renewing the covenant when the people arrive in Palestine to reinforce for the people the seriousness of their covenant responsibilities.

2. (27:9-10) Now that all the stipulations of the covenant have been explained, Moses at last declares to the nation, "You have now become the people of the LORD your God..." to initiate the covenant for the people.

3. (27:11-14) Moses prescribes the covenant renewal arrangement of the "blessing" tribes on Mount Gerizim and the "cursing" tribes on Mount Ebal with the Levites in between as an indication of which tribes receive God's special blessing.

4. (27:15-26) The Levites are to recite twelve curses, especially upon those who break the Decalogue and/or sin in secret, to inform Israel of the severity of disobeying the covenant.

B. (Ch. 28) Moses pronounces the blessings for obedience and curses for disobedience to motivate the nation to obey the covenant.

1. (28:1-14) Blessings for obedience include military prominence above the nations, material and agricultural prosperity, and a reputation before the world as having intimacy with God as incentive to the nation to obey the covenant.

2. (28:15-68) Curses for disobedience include horrible destruction, disease, drought, defeat in battle, physical and mental diseases of Egypt, oppression, exile, crop failure and economic ruin, besieged cities, and the destruction of the nation with disease and exile as incentive to the nation to obey the covenant.

**V. (Chs. 29—30) Moses' fourth sermon appeals for covenant obedience and assures ultimate blessing to motivate Israel to obey the covenant.**

A. (Ch. 29) Moses appeals to Israel for covenant obedience—committing itself afresh to the Mosaic Covenant in light of the LORD's past faithfulness and future curses for disobedience.

B. (30:1-10) Moses delineates the Palestinian Covenant to assure of prosperity after exile and repentance [at Christ's Second Coming before the Millennium] to teach that blessing is contingent upon repentance and to encourage Israel with the promise of ultimate blessing.

C. (30:11-20) Moses appeals to the nation to experience the prosperity of obedience (life) rather than the destruction of disobedience (death) since the people know exactly what the Law requires and can obey it, to maintain that the choices and consequences are clear.

**VI. (Chs. 31—34) The transition from Moses to Joshua as the covenant mediator instructs Israel in God's faithful provision for the continuity of the covenant while warnings of apostasy assert Israel's need to obey the covenant.**

A. (31:1-29) Moses appoints Joshua and deposits the Law while the LORD warns of Israel's future rebellion to convey to Israel the need for covenant faithfulness.



- B. (31:30—32:43) The Song of Moses which depicts Israel's gloomy future if it apostatizes is taught to the people for use in future covenant-renewal ceremonies as a reminder of their obligation to obey the LORD and His certain, righteous judgment if they fall away.
- C. (32:44—34:12) The death of Moses and replacement by Joshua instruct Israel in God's faithful provision for the continuity of the covenant.
1. (32:44-52) Preparation is made for Moses' death in his last address to the people and God's command for him to ascend Mount Nebo for his death.
  2. (Ch. 33) Moses blesses the tribes as his last will for the nation to thrive and experience the blessings of the covenant.
  3. (Ch. 34) Joshua records Moses' death and burial by the LORD on Mount Nebo after seeing the land from a distance, and Joshua is named as his replacement as an example of God's faithful provision for the continuity of the covenant.

## Moses' Farewell

It was almost time for a new leader to take over from Moses. Now Moses spoke to Israel. "Be strong and courageous. The Lord will go with you." Moses wrote down the Law, the first books of our Old Testament, and gave them to the priests so they could teach the people.

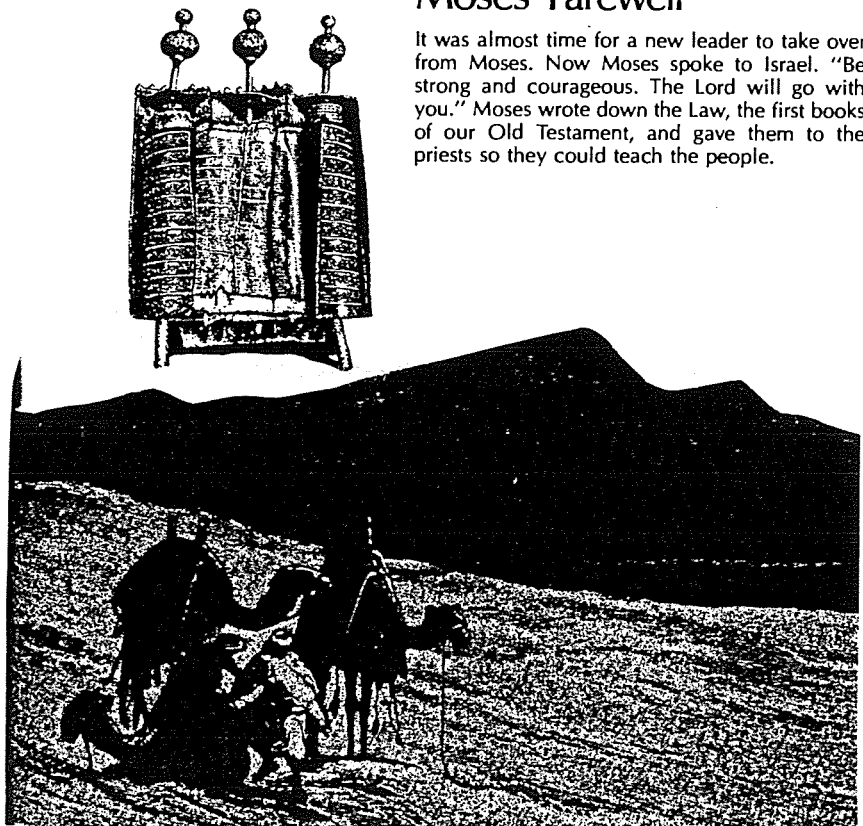

# Major Social Concerns in the Mosaic Covenant

Deuteronomy

*The Bible Visual Resource Book, 39*

## Major Social Concerns in the Covenant

### 1. Personhood

Everyone's person is to be secure (Ex 20:13; Dt 5:17; Ex 21:16-21,26-31; Lev 19:14; Dt 24:7; 27:18).

### 2. False Accusation

Everyone is to be secure against slander and false accusation (Ex 20:16; Dt 5:20; Ex 23:1-3; Lev 19:16; Dt 19:15-21).

### 3. Woman

No woman is to be taken advantage of within her subordinate status in society (Ex 21:7-11,20,26-32; 22:16-17; Dt 21:10-14; 22:13-30; 24:1-5).

### 4. Punishment

Punishment for wrongdoing shall not be excessive so that the culprit is dehumanized (Dt 25:1-5).

### 5. Dignity

Every Israelite's dignity and right to be God's freedman and servant are to be honored and safeguarded (Ex 21:2,5-6; Lev 25; Dt 15:12-18).

### 6. Inheritance

Every Israelite's inheritance in the promised land is to be secure (Lev 25; Nu 27:5-7; 36:1-9; Dt 25:5-10).

### 7. Property

Everyone's property is to be secure (Ex 20:15; Dt 5:19; Ex 21:33-36; 22:1-15; 23:4-5; Lev 19:35-36; Dt 22:1-4; 25:13-15).

### 8. Fruit of Labor

Everyone is to receive the fruit of his labors (Lev 19:13; Dt 24:14; 25:4).

### 9. Fruit of the Ground

Everyone is to share the fruit of the ground (Ex 23:10-11; Lev 19:9-10; 23:22; 25:3-55; Dt 14:28-29; 24:19-21).

### 10. Rest on Sabbath

Everyone, down to the humblest servant and the resident alien, is to share in the weekly rest of God's Sabbath (Ex 20:8-11; Dt 5:12-15; Ex 23:12).

### 11. Marriage

The marriage relationship is to be kept inviolate (Ex 20:14; Dt 5:18; see also Lev 18:6-23; 20:10-21; Dt 22:13-30).

### 12. Exploitation

No one, however disabled, impoverished or powerless, is to be oppressed or exploited (Ex 22:21-27; Lev 19:14,33-34; 25:35-36; Dt 23:19; 24:6,12-15,17; 27:18).

### 13. Fair Trial

Everyone is to have free access to the courts and is to be afforded a fair trial (Ex 23:6,8; Lev 19:15; Dt 1:17; 10:17-18; 16:18-20; 17:8-13; 19:15-21).

### 14. Social Order

Every person's God-given place in the social order is to be honored (Ex 20:12; Dt 5:16; Ex 21:15,17; 22:28; Lev 19:3,32; 20:9; Dt 17:8-13; 21:15-21; 27:16).

### 15. Law

No one shall be above the law, not even the king (Dt 17:18-20).

### 16. Animals

Concern for the welfare of other creatures is to be extended to the animal world (Ex 23:5,11; Lev 25:7; Dt 22:4,6-7; 25:4).

## Sacrifices at the High Places

One of the perplexing issues in the OT historical books concerns the high places. Were these spots alternate places to sacrifice to the LORD or did they always relate to pagan deities?

In patriarchal times, men like Job, Abraham, and Jacob built altars in many places and offered sacrifices. However, the first prohibition of sacrifices in various places is probably in Leviticus, which was revealed to the people at Mount Sinai even before they entered Canaan.

Any Israelite who sacrifices an ox, a lamb or a goat in the camp or outside of it instead of bringing it to the entrance to the Tent of Meeting to present it as an offering to the LORD in front of the tabernacle of the LORD — that man shall be considered guilty of bloodshed; he has shed blood and must be cut off from his people. This is so the Israelites will bring to the LORD the sacrifices they are now making in the open fields. They must bring them to the priest, that is, to the LORD, at the entrance to the Tent of Meeting and sacrifice them as fellowship offerings (Lev. 17:3-5).

A similar text commands sacrifice at only one spot (later revealed to be Jerusalem):

But you will cross the Jordan and settle in the land the LORD your God is giving you as an inheritance, and he will give you rest from all your enemies around you so that you will live in safety. Then to the place the LORD your God will choose as a dwelling for his Name — there you are to bring everything I command you: your burnt offerings and sacrifices, your tithes and special gifts, and all the choice possessions you have vowed to the LORD. And there rejoice before the LORD your God, you, your sons and daughters, your menservants and maidservants, and the Levites from your towns, who have no allotment or inheritance of their own. Be careful not to sacrifice your burnt offerings anywhere you please. Offer them only at the place the LORD will choose in one of your tribes, and there observe everything I command you (Deut. 12:10-14; cf. 14:23-25; 16:6, 11, 15-16).

The judgments for disobeying the Mosaic law included God's destruction of these places. God said if Israel persisted in sin, "I will destroy your high places, cut down your incense altars and pile your dead bodies on the lifeless forms of your idols, and I will abhor you" (Lev. 26:30). For this reason God commanded the people, "Drive out all the inhabitants of the land before you. Destroy all their carved images and their cast idols, and demolish all their high places" (Num. 33:52; Deut. 33:29).

But Israel did not destroy them. In fact, after entering the land we find Samuel offering a sacrifice at a high place (1 Sam. 9:12-25; cf. 10:5, 13) where they were certainly legitimate (Homer Heater, "A Theology of Samuel and Kings," *Biblical Theology of the OT*, ed. Roy B. Zuck, 117, 126).

God even granted Solomon's request for wisdom at "the most important high place" (1 Kings 3:4)! How are we to deal with these texts, especially the last one which is preceded by the clear statement, "Solomon showed his love for the LORD by walking according to the statutes of his father David, except that he offered sacrifices and burned incense on the high places" (1 Kings 3:3). It appears that God is both blessing and condemning high place sacrifice in the same text.

Perhaps the solution is found one verse earlier still: "The people, however, were still sacrificing at the high places, because a temple had not yet been built for the Name of the LORD" (1 Kings 3:2). Maybe God evidently made a concession to His command in Leviticus until the temple was built.

Yet after the temple was built, high place sacrifice was prohibited outright. Pagan high places were built by Solomon (1 Kings 11:7)—the very king who built the temple! And Jeroboam built them at Bethel and Dan to prevent the people in the north from going down to Jerusalem to sacrifice at the temple (1 Kings 12:31-32; 13:2, 32-33). Many kings made the mistake of allowing these places to continue (1 Kings 14:23; 15:14; 22:43; 2 Kings 12:3-4; 14:4; 15:4, 35; etc.). Brief revivals occurred when these places were torn down by Hezekiah (2 Kings 18:4) and Josiah (2 Kings 23:5-20), but the general practice was to rebuild them.

Disagreeing with this analysis is Heater, who states, "When David brought the ark to Jerusalem, the centralization of worship began. The high places, *legitimate places of worship*, continued throughout the history of the monarchy, but Jerusalem, the home of the Ark, increasingly became the center of worship" (ibid, 126-27, *italics mine*).

## Grumbling in the Wilderness

Paul N. Benware, *Survey of the Old Testament*, 68

God hates complaining. This is why He commands believers to do all things without complaining and arguing (Phil. 2:14).

Unfortunately, Israel did not learn this lesson very well. The following summary shows how God initially tolerated the people's complaining in the wilderness by supplying their needs in the Exodus account. However, in Numbers most of the time He judged grumbling in severe ways. By the time the people were poised to enter the land in Deuteronomy, they had lost thousands of fellow Israelites to the complaining sickness.

Notice also Moses' response to the people's complaints. Never did he join in with them in this sin but rather nearly always brought it to the Lord as well as rebuked the people for their ungratefulness. Are there any lessons in spiritual leadership for you here?

### ISRAEL'S COMPLAINTS IN THE WILDERNESS

SCRIP- TURE	ISRAEL'S COMPLAINT	MOSES' RESPONSE	GOD'S RESPONSE
Ex. 14:11	Grumbled at the sight of Pharaoh's army	Encouraged Israel to trust God	Delivered Israel
Ex. 15:24	Grumbled about the bitter water	Cried out to God	"Healed" the water
Ex. 16:2	Grumbled about the lack of food	Rebuked Israel	Supplied manna
Ex. 17:2	Grumbled about the lack of water	Prayed to the Lord	Water from the rock
Num. 11:1	Grumbled about God's provision of food	Anger and prayer	Judgment
Num. 14:2	Grumbled about Moses' leadership. Can't possess Canaan	Pled with Israel, prayed to the Lord	Judgment
Num. 16:2	Grumbled about Moses' leadership	Rebuked and prayed	Judgment
Num. 16:41	Grumbled about Moses	Prayed	Judgment
Num. 20:2	Grumbled about Moses and a lack of water	Rebuked Israel Struck rock	Supplied water
Num. 21:4	Grumbled about Moses and the manna	No response	Judgment

## Covenant Contrasts

There are only four key eschatological covenants in Scripture. They share these traits in common:

1. Unconditional
2. Eternal
3. Partially & spiritually fulfilled at present
4. Fully & literally fulfilled in the future
5. Universal in scope

Yet they can be contrasted in many ways as well (see also pages 21-22, 55a, 59-61, 116):

	<b>Abrahamic</b>	<b>Palestinian</b>	<b>Davidic</b>	<b>New</b>
<b>Definition:</b> <i>God's promise to give Israel...</i>	land, rule, and blessing to benefit the world	<i>physical land</i> from the Wadi of Egypt to the Euphrates River (Gen. 15:18)	<i>political rule</i> of a descendant of David forever from Zion	<i>spiritual blessings</i> of national cleansing and restoration
<b>Relationship</b>	Umbrella	Land	Seed	Blessing
<b>Key Text</b>	Gen. 12:1-3	Deut. 30:1-10	2 Sam. 7:12-16	Jer. 31:31-34
<b>Recipient</b>	Abraham	Moses	David	Jeremiah
<b>Date</b>	2060 BC	1445 BC	1004 BC	595 BC
<b>Place</b>	Ur of Chaldees	Mt. Sinai	Jerusalem	Jerusalem
<b>Personal Blessings to First Recipient</b>	Possessions & name blessed, son, opposers disciplined	Privilege of seeing Canaan from afar	Sons ("house") never wiped out (Matt. 1:1-17)	—
<b>National Blessings</b>	A great nation would come from Abraham	Reproof (exile) Regathering Reunited (Isa. 11:11-16) Repentance Restored land prosperity	Temple (via son) Righteous king to rule (a Davidic descendant) over a kingdom where Israel prominent (Isa. 11:1-5)	Reuniting of Israel and Judah Forgiveness Indwelling Spirit New heart 100% Christian (Ezek. 36:25-38)
<b>Universal Blessings</b>	All nations blessed through Christ	World blessed via visiting Jerusalem (Zech. 14:16-19)	Kingdom (political rule over entire world)	All the world evangelised
<b>Present (Partial) Fulfillment</b>	Church as spiritual seed of Abraham (Gal. 3:5)	Regathering & rebirth of modern Israel (Ezek. 37:7-8)	Church as spiritual temple (Eph. 2:19-22) & Christ as the King awaiting rule	Law abolished, forgiveness, new nature and Spirit indwelling
<b>Future (Full) Fulfillment</b>	All four covenants fulfilled in the millennial kingdom	Israel given full borders (Ezek. 37:8-28; 47-48)	Christ rules world (Isa. 2, 11) with saints (Rev. 5:10)	World 100% Christian and Israel/Judah reunited

## Key OT Passages about the Land

David Larsen, *Israel, Gentiles and the Church*, 26 (adapted in Jeremiah texts)

Perhaps more than with any religious group (including Christians), the heart of Judaism lies in the land of its forefathers. The land and the people are inseparable to Jews, for they experienced God's very presence indwelling the temple in Jerusalem for centuries (966-586 BC). This emphasis on the land of Canaan is repeated numerous times in the Old Testament:

Genesis	12:7; 13:14-17; 15:7-21; 17:1-8; 24:7; 28:13-15	Jeremiah	12:14-17; 16:14-15, 18; 18:16; 23:5-8; 30:18-21; 31:10-14, 21-40; 32:37-41; 33:10-13
Exodus	12:25; 13:5, 11; 32:13; 33:1	Ezekiel	11:17-21; 17:22-24; 34:11-31; 37:1-14
Numbers	11:12; 14:15-16, 23; 32:8	Hosea	13:9-14:9
Deuteronomy	1:8; 6:10; 9:28; 12:20; 19:8; 27:3	Micah	2:12
Joshua	23:5	Zephaniah	2:19-20
Isaiah	5:25-26; 11:11-12; 66:19-20	Zechariah	12:10-11

Which books have the greatest emphasis on the land?

Why do you think this is so?

## Israel's Future in Deuteronomy 28-32

Adapted from Wilbur M. Smith, "Prophecies Regarding Israel," *Moody Monthly* (December 1958), 39 (Quoted by Larsen, 23-24)

*Deuteronomy 28-32 summarizes Israel's future from Moses' time to a time yet future. These prophecies are repeated throughout the Old Testament.*

<b>31:16-21</b>	Israel will turn away from the Lord (began after Joshua's death)
<b>28:15-60</b>	God will judge Israel in the land for her apostasy (period of judges and divided kingdom)
<b>28:32-39, 48-57</b>	Israel will be taken captive (by Assyria and Babylon)
<b>28:33</b>	Israel's enemies will possess her land for a time (Babylon, Persia, Greece, Romans, Catholic Crusades, Muslims, Britain, etc.)
<b>28:38-42; 29:23</b>	The land will remain desolate (AD 70 to AD 1948)
<b>28:63-67; 32:26</b>	Israel will be scattered among the nations "from one end of the earth to the other" (28:64; AD 70 to AD 1948)
<b>28:62</b>	Israel will be "few in number" (today Jews comprise ½ of 1% of the world's population)
<b>28:44-45</b>	Though punished, Israel will not be destroyed if she repents
<b>28:40-41; 30:1-2</b>	Israel will indeed repent in her tribulation (trials have continued throughout the ages but will increase in the 72 month Great Tribulation)
<b>30:3-10</b>	God will regather Israel from the nations and bring her back to her divinely given land (it began in the late 1800s in unbelief as predicted in Ezekiel 37:7-8 and continues even today)
<b>30:3-13; 28:1-14</b>	Israel's obedience will be blessed in numerous ways (worldwide acclaim and prosperity in the millennial kingdom)





# Introduction to the Historical Books

HISTORICAL	POETICAL	PROPHETICAL
Genesis Exodus Leviticus Numbers Deuteronomy	Job Psalms Proverbs Ecclesiastes Song of Solomon	Isaiah Jeremiah Lamentation Ezekiel Daniel
Joshua Judges Ruth 1 Samuel 2 Samuel 1 Kings 2 Kings 1 Chronicles 2 Chronicles		Hosea Joel Amos Obadiah Jonah Micah Nahum Habakkuk Zephaniah
Ezra Nehemiah Esther		Haggai Zechariah Malachi

After the Pentateuch, the diary of God's workings in the Old Testament times is registered for us in the Historical Books. These books break naturally into three divisions. The first group, consisting of Joshua, Judges and Ruth, brings the children of Israel into the Promised Land and pictures their life there for some 400 years. The books of Joshua and Judges provide striking contrast. Joshua is a book of conquest; Judges is a book of defeat. Joshua shows the children of Israel stepping out in faith to conquer the land; Judges shows the same people stumbling around in faithlessness. Joshua shows Israel pressing onward; Judges pictures them spiralling downward. Seven times over in the book of Judges, God's children fall into a horrible five-step cycle: their idolatrous *sin* is followed by punishment from God in the form of *servitude* to a foreign nation; in distress they cry out in *supplication* to the Lord; God provides *salvation* from the oppressor in the form of a judge; and finally, the land enjoys *silence* or rest . . . until the next wave of *sin* begins the cycle over again.

The little book of Ruth is the only light in the dark period of the Judges. Contrasting with the bleakness of Israel's history during the time when men were utterly sinful, Ruth pictures a woman who was totally faithful.

The second major division within the Historical section contains the kingdom books: 1 Samuel, 2 Samuel, 1 Kings, 2 Kings, 1 Chronicles and 2 Chronicles. 1 Samuel traces the rise of the monarchy through Samuel and King Saul. 1 Chronicles and 2 Samuel disclose the rise, reign and ruin of King David. Except for scattered high points during the reigns of David and his successor, Solomon, the kingdom period is a time of decline. 1 Kings, 2 Kings, and 2 Chronicles describe this decline. When Rehoboam dons the crown, the nation splits over the issue of taxes: Israel occupying the North, and Judah the South. Quickly both nations begin an accelerating downward slide which continues until God's discipline deposits them in captivity. 2 Kings records the captivity of Israel by Assyria and ends with the Exile of Judah in Babylonia.

The third major division in the Historical section is formed by Ezra, Nehemiah and Esther. Ezra's goal is to show the return of God's people to their homeland. The Babylonian captivity ends with the Persian defeat of Babylonia, and the order by the Persian king, Cyrus, allowing the Jews to return to Jerusalem. Ezra's writings contain two returns: the first under Zerubbabel (chapters 1-6), and the second under Ezra (chapters 7-10). While the book of Ezra concludes with the Jews living in their land and worshipping in their temple, it is left for Nehemiah to supervise the reconstruction of the walls.

The book of Esther actually fits between chapters 6 and 7 of the book of Ezra. Esther is a brief summary of events in Persia affecting Jews who have decided not to return to their homeland. The book teaches that God sovereignly protects His children even in the midst of their disobedience to Him.

# Joshua

<b>Partial Occupation of Canaan</b>			
<b>Conquered</b>		<b>Settled</b>	
<b>Chapters 1–12</b>		<b>Chapters 13–24</b>	
<b>Swords</b>		<b>Spoils</b>	
<b>Faith Demonstrated</b>		<b>Faith Rewarded</b>	
<b>Entering Canaan</b>	<b>Conquering Canaan</b>	<b>Dividing Canaan</b>	
<b>Preparation</b>	<b>Subjection</b>	<b>Possession</b>	
<b>Jordan River</b>	<b>Canaan</b>	2 1/2 Eastern Tribes 9 1/2 Western Tribes	
<b>ca. One Month</b>	<b>ca. 7 Years</b>	<b>ca. 18 Years</b>	
<b>Preparation (1–5)</b>	<b>Process (6–12)</b>	<b>Partitioning (13–21)</b>	<b>Principles (22–24)</b>

**Key Word:** Occupation

**Key Verse:** “Do not let this Book of the Law depart from your mouth; meditate on it day and night, so that you may be careful to do everything written in it. Then you will be prosperous and successful” (Joshua 1:8)

**Summary Statement:**

Joshua records Israel's occupation of most of Canaan in fulfillment of God's faithfulness to His promise through Joshua's faith in order to instruct the nation that obedient faith based upon God's promises brings blessing.

**Applications:**

Obedient faith based upon God's promises brings blessing.

Partial obedience results in difficulty.

# Joshua

## Introduction

**I. Title** The Hebrew text provides the same name as in the English, namely Joshua (יְהוֹשֻׁעַ *Yehosua'*) which literally means "Yahweh saves" or "Yahweh is salvation" (BDB 221c 1). His original name was *Hoshea*, "salvation" (Num. 13:8), but Moses changed it to *Yehoshua*, "Yahweh is salvation" (Num. 13:16), which is the Hebrew equivalent for the Greek name *Iesous*, Jesus. The appropriateness of this title stems from the fact that Joshua appears as the main character and his mission as leader of Israel is to help the people understand that God, not he, saves them by conquering the Canaanites and apportioning their land to them.

## II. Authorship

- A. **External Evidence:** Jewish tradition ascribes the work to Joshua himself. The Talmud says that Joshua wrote all but the last five verses which were recorded by Phineas.
- B. **Internal Evidence:** The text claims that Joshua wrote at least parts of the book (8:32; 24:26). Several lines of evidence point to a very early composition: (1) The author is an eyewitness to the events as "we" and "us" describe the participants (5:1, 6), (2) Rahab was still living (6:25), (3) The Jebusites still inhabited Jerusalem (15:63), and (4) Old names of the Canaanite cities are employed (e.g., Kiriath Arba for Hebron in 15:13).

However, although the unity of style and organization suggest a single author, three sections must have been written after Joshua's death: (1) Othniel's capture of Kirjath Sepher (15:13-19; cf. Judges 1:9-15), (2) The northern migration of the tribe of Dan (19:47; cf. Judges 18:27-29), and (3) Joshua's death and burial (24:29-33). Many evangelical scholars attribute these minor additions to Eleazer the priest and his son Phineas (24:33) during the time of the judges.

Joshua was born a slave in Egypt into the "half-tribe" of Ephraim, was redeemed from slavery at 40 years old (Moses' "young aide"; cf. Exod. 33:11), began leading Israel at 80 years old, and led the nation for 30 years until his death at the age of 110 (24:29).

## III. Circumstances

- A. **Date:** The date of the conquest of Canaan hinges, of course, upon the date of the Exodus (see Exodus notes for support of the early date of ca. 1446 BC). Caleb was age forty at Kadesh one year after the Exodus (14:7; 1445 BC) and eighty-five at the conclusion of the conquest (14:10). Since this forty-five year difference included thirty-eight years of wanderings it leaves a seven year conquest from 1405-1398 BC (the wanderings being from 1445-1405 BC). This places the entrance into Canaan at 1405 BC and the conclusion of the Book of Joshua seven years later in 1398 BC Joshua died many years later at the age of 110 (23:1; 24:29). Some believe he died only eight years later (cf. *TTTB*, 53, and Schmidt's chronology chart "Old Testament Patriarchs and Judges") but a more reasonable guess is about ten to twenty years later (Campbell, *BKC*, 1:367). Therefore, the Book of Joshua, apart from minor additions, was written after 1398 and perhaps as late as 1378 BC.
- B. **Recipients:** The first readers of Joshua's book were Israelites in Canaan with him following the conquest of the land.
- C. **Occasion:** Moses had just died after leading Israel in forty years of wilderness wanderings. Then Joshua took the helm to lead the nation to take possession of the land God had promised. One teacher has noted that if the second book of the Bible is properly called *Exodus* ("the way out"), then this sixth book may be deemed *Eisodus* ("the way in")! In this book the nation experiences the partial fulfillment of the promise of the land which stems all the way back to Abraham nearly 600 years earlier (cf. Gen. 12:7).

#### IV. Characteristics

- A. Joshua marks a new method of God's communication to His people. Up to this point (i.e., in the Pentateuch) Jehovah spoke through dreams, visions, or angels. However, beginning with Joshua, the Law of Moses becomes the voice of God in written form (1:8). The importance of the written word is emphasized in the examples and commands to obey it (1:7, 8c; 23:6-16), talk about it (1:8a), meditate upon it (1:8b), honor it (8:32-33), and read it (8:34-35).
- B. In the Hebrew canon the Book of Joshua heads the grouping of books called the "Prophets." The reason for this is debated, but some suggest that Joshua held the office of a prophet. Others understand the placement as indicating that this book (among the "Former Prophets") illustrates the principles preached by the prophets (Campbell, *BKC*, 1:325).
- C. Joshua records the *incomplete* possession of the land. Although the ownership of the land was unconditional (Gen. 12:7; 15:18-21; 17:8), possession was conditional (Deut. 29:9—30:20). Although God promised the entire land of Canaan (1:4), the Israelites did not possess it all because they did not trust God for it all (13:1). Therefore, the Palestinian Covenant which promises the land from the Wadi of Egypt to the Euphrates River (Gen. 15:18) was not fulfilled under Joshua. In fact, it still remains unfulfilled.
- D. Many common themes connect Deuteronomy and Joshua:

<u>Theme</u>	<u>Deuteronomy</u>	<u>Joshua</u>
Holy War	How to do it (instructed)	How it was done (implemented)
Possessing Canaan	Promised	Possessed
Joshua's Role	Appointed	Operated
Law of Moses	Stated	Restated (Josh. 23—24)

### Argument

The Book of Joshua divides easily into two parts, both of which indicate the partial occupation of the Promised Land by Israel in fulfillment of God's promise. The first part (chs. 1—12) records how the nation conquers the land of the Canaanites through a careful preparation (chs. 1—5) and exploits through Joshua's faith in God (chs. 6—12). The second part (chs. 13—24) describes how the conquered land is settled by partitioning it into allotted areas for the respective tribes (chs. 13—21) and how this land stays settled by obedience to the covenant (chs. 22—24). The purpose of each of these sections is to instruct the nation that obedient faith based upon God's promises brings blessing.

### Synthesis

#### Partial Occupation of Canaan

#### Partial fulfillment of the land promise

1—12	Land conquered
1—5	Preparation
1	Charge
2	Spies
3	Jordan crossing
4	Memorial
5:1-12	People prepared: Ceremonies
5:13-15	Joshua prepared: Angel
6—12	Process
6—8	Central: Jericho, Ai
9—10	Southern: Gibeonites, Amorites
11:1-15	Northern: Coalition
11:16—12:24	Summary

<b>13—24</b>	<b>Land settled</b>
13—21	Partitioning
13:1-7	Philistia unallotted
13:8-33	Eastern (2 1/2)
14:1—19:48	Western (9 1/2)
14—15	Judah: Caleb, rest
16—17	Joseph
18:1—19:48	7 tribes
19:49—21:45	Joshua, manslayers, Levites
22—24	Principles
22	Civil war averted: unity
23:1—24:27	Covenant renewal: obedience
24:28-33	Burials: faith

## Outline

### Summary Statement for the Book

**Joshua records Israel's occupation of most of Canaan in fulfillment of God's faithfulness to His promise through Joshua's faith in order to instruct the nation that obedient faith based upon God's promises brings blessing.**

- I. (Chs. 1—12) Israel conquers the Promised Land through Joshua's military and spiritual preparation followed by obedient conquest to teach God's faithfulness to His promise and Israel's need for obedience to enjoy His blessings.
  - A. (Chs. 1—5) Israel's preparation for occupation of the Promised Land is accomplished by Joshua's military and spiritual leadership of the people to instruct the nation in faith towards God and His leaders.
    1. (Ch. 1) Joshua, with divine approval, commands the people to courageously conquer the land in God's strength and they accept his challenge as evidence of their trust in God and His leadership founded in God's Word.
    2. (Ch. 2) Joshua's faith in God is strengthened by two military spies who are sent secretly and return from the believing Rahab of Jericho with a favorable report to record God's grace towards all who trust Him.
    3. (Ch. 3) Joshua's faith in God is demonstrated in the miraculous crossing of the Jordan which poises Israel strategically for conquest in order to teach Israel the necessity of faith in God and the authoritative word of His leaders while renouncing its past life.
    4. (Ch. 4) The LORD commands the nation to build a twelve stone pile as a memorial of His miraculous provision in crossing the Jordan to teach Israel a spiritual lesson—not to forget God's workings on its behalf.
    5. (5:1-12) Joshua prepares Israel spiritually through circumcision, Passover, and eating of unleavened bread (rather than manna) to separate the people as committed to God's promise that Israel might recognize that His blessings must be claimed by faith.
    6. (5:13-15) Joshua is himself prepared for conquest by the appearance of the preincarnate Christ who really commands Israel's army, to comfort Joshua with the realization that he need not bear the responsibility of leadership alone.
  - B. (Chs. 6—12) Israel's process of occupying Canaan is accomplished by conquering each region separately to instruct the nation in the necessity of faith in and obedience to God's sovereign will to enjoy His promised blessing.
    1. (Chs. 6—8) The conquest of central Canaan's fortified cities of Jericho and Ai recalls the need for complete obedience to experience the blessing of God.

- a. (Ch. 6) Israel miraculously and unusually defeats Jericho against tremendous odds to teach the nation that it must obey God's plan for victory.
  - b. (Chs. 7—8) The initial defeat of Israel by Ai before it finally conquers the city is recorded to point out how sin among the people prevents them from experiencing God's deliverance.
2. (Chs. 9—10) The conquest of southern Canaan affirms the necessity of faith in God instead of self-confidence to experience victory.
    - a. (Ch. 9) The foolish covenant made to spare the deceptive Gibeonites shows the importance of consulting God rather than reliance upon human wisdom.
    - b. (Ch. 10) The defense of the Gibeonites through God's hailstones and prolonged daylight allows the defeat of the Amorites and eventually all of southern Canaan as evidence that only complete faith and obedience can defeat the enemy.
  3. (11:1-15) The conquest of northern Canaan is accomplished through the defeat of the entire coalition of northern armies simultaneously to note the sovereign hand of God who directs events to fulfill His promise.
  4. (11:16—12:24) A summary of the conquest of Canaan's areas and kings is provided as indication of the fulfillment of God's promise that Israelites would possess every place where they stepped (cf. 1:3).

**II. (Chs. 13—24) Israel settles the Promised Land in fulfillment of God's promise, teaching that obedient faith based upon His promises brings blessing.**

- A. (Chs. 13—21) Israel's partitioning the occupied Promised Land in allotments to each tribe and to Joshua, manslayers, and Levites teaches Israel the joyful rewards of faith and obedience.
  1. (13:1-7) The coastal regions are not allotted to any tribe since the nation failed to conquer these areas to teach Israel that it possessed only the land which it would set foot upon according to the promise of God (cf. 1:3).
  2. (13:8-33) The portions for the two and one-half eastern tribes are designated to teach Israel the joyful rewards of faith and obedience.
  3. (14:1—19:48) The portions for the nine and one-half western tribes are designated to teach Israel the joyful rewards of faith and obedience.
    - a. (Chs. 14—17) The allotments for Judah, Joseph, and the half-tribe of Manasseh are determined by lot in Gilgal.
      - 1) (Chs. 14—15) Judah's allotment stretches across southern Canaan from the Dead Sea to Philistia.
        - a) (Ch. 14) The boundaries of Caleb's allotment occupies a portion in the southeastern part of the territory of Judah.
        - b) (Ch. 15) The boundaries of the rest of Judah stretch from the Dead Sea over to Philistia in every area except the Jebusite city of Jerusalem.
      - 2) (Chs. 16—17) Joseph's allotment for Ephraim and the half-tribe of Manasseh covers the entire central portion of Canaan from the Jordan River to the Mediterranean Sea.
    - b. (18:1—19:48) The allotments for the remaining seven tribes are determined by topographical survey and by lot in Shiloh.

- 1) (18:1-10) The remaining tribes move to Shiloh where the new method of assigning inheritances also includes a topographical survey of the land along with the casting of lots.
  - 2) (18:11—19:48) Allotments for Benjamin, Simeon, Zebulun, Issachar, Asher, Naphtali, and Dan complete the remaining undesignated land portions.
4. (19:49—21:45) The portions for Joshua, manslayers, and Levites are designated to teach Israel the joyful rewards of faith and obedience.
- a. (19:49-51) Joshua's allotment of the city of Timnath Serah in the hill country of Ephraim is granted to him by the Israelites.
  - b. (Ch. 20) Six cities of refuge among the Levite towns are designated for manslayers of accidental deaths to live until standing trial and until the death of the high priest.
  - c. (Ch. 21) Forty-eight towns are given to the Levites throughout the land since they do not receive a geographical inheritance.
- B. (Chs. 22—24) Israel's principles of occupying the Promised Land include the importance of unity, obedience, and faith to motivate a covenant renewal as the basis for continued occupancy of the land.
1. (Ch. 22) Civil war is averted when the western tribes nearly go to war with the eastern tribes, who build an altar as a remembrance of their need to worship the LORD at His sanctuary, recorded to stress the importance of unity within Israel.
  2. (23:1—24:27) Joshua's charge to covenant renewal before his death insists that God's blessings come only through obedience to motivate Israel to understand that covenant obedience is the basis for continued occupancy of the land.
  3. (24:28-33) The appendix, probably penned by Phineas, records the burials of three men—Joshua, Joseph's bones, and Eleazer—who once lived in Egypt yet are buried in Canaan to encourage Israel to faith in God's faithfulness to keep His promises.

## Miraculous Crossings

<b>Reed (Red) Sea</b>	<b>Jordan River</b>
Exodus 14	Joshua 3
A Sea	A River
Moses	Joshua
Begins the Wanderings	Ends the Wanderings
Leaving Egypt	Leaving Moab
Entering Sinai	Entering Canaan
Egyptians Killed	No-One Killed
Song Memorial (Exod. 15)	Stone Memorial (Josh. 4)
Narrow Channel (Exod. 14:22)	30 Km Plain (Josh. 3:16)
Took All Night	Took a Few Hours
Pillar Led the Way	Priests Led the Way
Circumcision Preceded	Circumcision Followed
Passover Preceded	Passover Followed
Complaining Followed	Conquering Followed
Gave Freedom	Gave Rest*
Signifies Salvation	Signifies Glorification
Antitype is Christian Life	Antitype is Kingdom Life
2 Million People	2 Million People
10 <sup>th</sup> day of 1 <sup>st</sup> Month (Exod. 12:2-3)	10 <sup>th</sup> day of 1 <sup>st</sup> Month (Josh. 4:19, 23)
= 10 Nisan 1445 BC	= 10 Nisan 1405 BC

\* Josh. 1:13, 15; 22:23b; 14:15; 21:44; 22:4; 23:1



## Battles of Joshua's Conquest

John H. Walton, *Chronological and Background Charts of the OT*, 2d ed., 38

SECURING THE CENTRAL CORRIDOR		
OPPONENT	BATTLE SITE	JOSHUA REFERENCE
Jericho	Jericho	6:12-27
Ai	Ai	7:2-6
Ai and Bethel	Ai	8:1-29
THE SOUTHERN COALITION		
Coalition of Amorites led by Adoni-Zedek of Jerusalem and including Hebron, Jarmuth, Lachish, and Eglon	Initial encounter at Gibeon with pursuit through Beth-Horon and the Valley of Aijalon ending at Azekah	10:1-27
Follow-up sieges at Makkedah, Libnah, Lachish, Gezer, Eglon, Hebron, and Debir (10:28-39)		
THE NORTHERN COALITION		
Coalition led by Jabin of Hazor and including many cities of the north	Initial encounter by the Waters of Merom with pursuit west to Sidon and Misrephoth-maim and the Mizpeh Valley to the NE	11:1-9
Follow-up sieges at Hazor and other royal cities unnamed (11:10-15)		

This false story is from a church newsletter in California (May 1998).  
See the next page for the truth of the story.



Did you know that the space program is busy proving that what has been called "myth" in the Bible is true? Mr Harold Hill, President of the Curtis Engine Company in Baltimore Maryland and a consultant in the space program, relates the following development.

I think one of the most amazing things that God has for us today happened recently to our astronauts and space scientists at Green Belt, Maryland. They were checking the position of the sun, moon and planets out in space; where they would be 100 years and 1000 years from now. We have to know this so we won't send a satellite up and have it bump into something later on its orbits. We have to lay out the orbits in terms of the life of the satellite and where the planets will be so the whole thing will not bog down.

They ran the computer measurement back and forth over the centuries and it came to a halt. The computer stopped and put up a red signal, which meant that there was something wrong either with the information fed into it or with the results as compared to the standards. They called in the service department to check it out and they said "What's wrong?" Well they found there is a day missing in space in elapsed time. They scratched their heads and tore their hair. There was no answer.

Finally, a Christian man on the team said, "You know, one time I was in Sunday School and they talked about the sun standing still."

## Space Scientists Discover Biblical Truth

While they didn't believe him, they didn't have an answer either, so they said, "Show us". He got a Bible and went back to the book of Joshua where they found a pretty ridiculous statement for any one with "common sense." There they found the Lord saying to Joshua, "Fear them not, I have delivered them into thy hand; there shall not a man of them stand before thee." Joshua was concerned because he was surrounded by the enemy and

and found it was close but not close enough. The elapsed time that was missing back in Joshua's day was 23 hours and 20 minutes--not a whole day. They read the Bible and there it was "*about* (approximately) a day" These little words in the Bible are important, but they were still in trouble because if you cannot account for 40 minutes you'll still be in trouble 1,000 years from now. Forty minutes had to be found because it can be multiplied many times over in orbits.

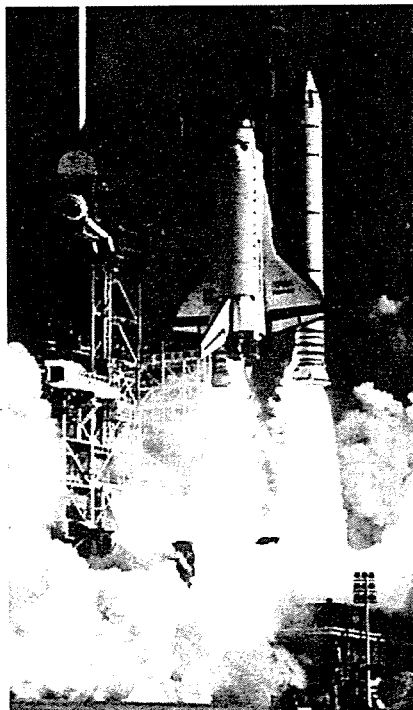

if darkness fell they would overpower them. So Joshua asked the Lord to make the sun stand still! That's right--"The sun stood still and the moon stayed---and hasted not to go down *about* a whole day!"

The astronauts and scientists said, "There is the missing day!" They checked the computers going back into the time it was written

As the Christian employee thought about it, he remembered somewhere in the Bible where it said the sun went BACKWARDS. The scientists told him he was out of his mind, but they got out the Book and read these words in 2 Kings: Hezekiah, on his deathbed, was visited by the prophet Isaiah who told him that he was not going to die. Hezekiah asked for a sign as proof. Isaiah said "Do you want the sun to go ahead 10 degrees?" Hezekiah said "It is nothing for the sun to go ahead 10 degrees, but let the shadow return *backward* 10 degrees." Isaiah spoke to the Lord and the Lord brought the shadow ten degrees BACKWARD! Ten degrees is exactly 40 minutes! Twenty three hours and 20 minutes in Joshua, plus 40 minutes in Second Kings make the missing day in the universe! Isn't it amazing? Our God is rubbing their noses in His Truth! Check this out for yourself!

References  
Joshua 10:8 and 10:12-13  
2 Kings 20:9-11

Editor's Note: This article was received by e-mail and checked for publication.

## The Harold Hill Myth

From: KBertsche@aol.com  
Subject: Harold Hill Myth  
Date: Sun, 7 Jun 1998 19:46:26 EDT

I have received four e-mails repeating the "Harold Hill Myth" in the past month, so thought it warranted a detailed response. Please forward this message to anyone who sends the story to you, anyone you have sent it to, or anyone you think may be influenced by it. The "Harold Hill Myth" is a Christian "urban legend" which has been circulating for some 30 years now in its present form. It is based on a book published more than 100 years ago, in 1890. It has recently started making its way around the internet.

The story by Harold Hill tells about NASA scientists who were back-calculating the positions of celestial bodies, and their computers balked at inconsistencies in the calculations until a Christian in the crowd persuaded them to insert the missing day of Joshua [Josh. 10:8, 12-13] and the missing 40 minutes of Hezekiah [2 Kings 20:9-11], which made the computers happy and verified these biblical miracles [see previous page for the full story].

Firstly, this is complete, utter nonsense! In calculating to find the motion of heavenly bodies, there is no way of telling whether days, hours, or months were missing in the past. The equations will happily run forwards or backwards, ignorant of these things. Without an external reference to compare the calculations to no one will know that they are calculating incorrect positions when the equations are run backwards.

Secondly, the source of the story is highly dubious. The account is denied by NASA. While there is indeed a Harold Hill who recounts this story, he had only a VERY peripheral contact with NASA. Believers who have investigated the story have uncovered his dubious connection to NASA, and an older, very similar story by Rimmer in 1936 (long before NASA), claiming to be based on Totten's book in 1890 (more than 100 years ago!), which was apparently not based on any celestial calculations. It seems that this is an old story which has been embellished over the years, and that the celestial mechanics and NASA connection has absolutely no basis in fact.

It is very disappointing to me that in our modern, sophisticated, scientific society, people can still be duped by such nonsense. I don't know if this indicates the poor state of science education in this country or the reluctance of Christians to think critically (probably some of each). We need to be "as wise as serpents" (Mt. 10:16), and skeptical of such accounts. We do not want or need to resort to lies to support the truth of the Scriptures! As James Kiefer says of this myth, "MORAL: When you encounter stories that appear to confirm the truth of the Christian faith, and you cannot trace them back to a reliable source, or when there are unanswered questions like 'How do we know this?', it is best, in evaluating them, to err on the side of too much skepticism rather than too little."

Kirk Bertsche, PhD

---

Note: Dr. Bertsche has a PhD in Physics and was studying at Western Seminary, San Jose, CA when he wrote this email in 1998. For more information, he gives these links (updated on 2 April 2012 from his email):

<http://www.snopes.com/religion/lostday.asp>

<http://www.57piano.com/scispks.htm#Mark11>

[http://imagine.gsfc.nasa.gov/docs/ask\\_astro/answers/970325g.html](http://imagine.gsfc.nasa.gov/docs/ask_astro/answers/970325g.html) (Note: this last reference has good science, but betrays a low and overly restrictive view of biblical truth.)

# Conquest of Canaan

The Bible Visual Resource Book, 45

Joshua

## Conquest of Canaan

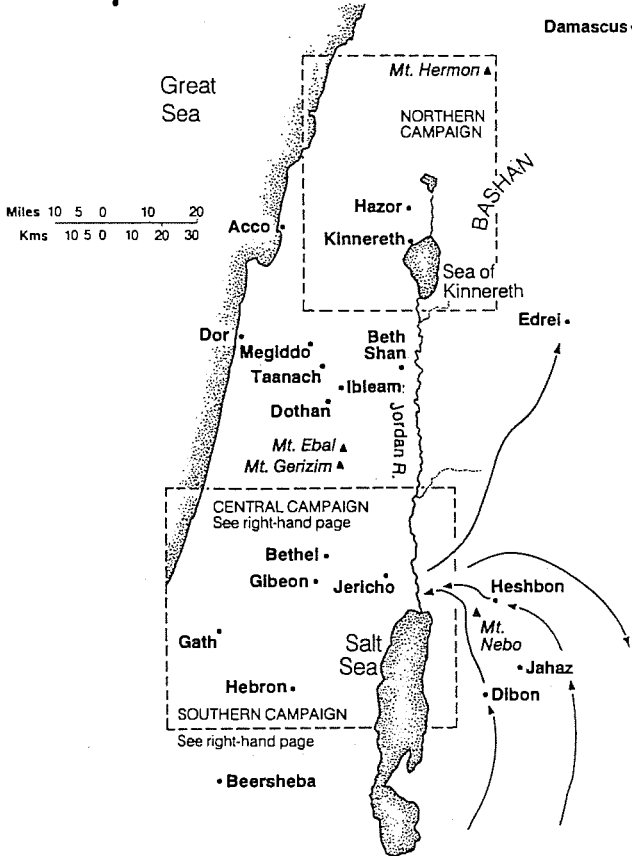

### 4. THE NORTHERN CAMPAIGN

Late Bronze Age Hazor was burned by Joshua (Jos 11:13). Excavations have revealed three clearly datable destruction layers, one of which may provide the strongest evidence yet for a historically verifiable date for the conquest. The excavator thought Joshua burned the latest level (c. 1230 B.C.), but others argue that it must actually have been the earliest of the three levels, c. 1400 B.C.

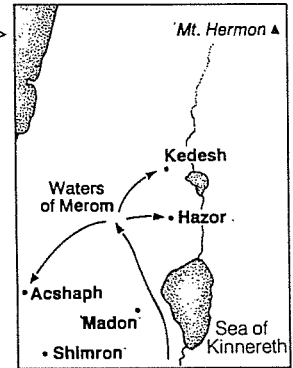

### 1. ENTRY INTO CANAAN

When the Israelite tribes approached Canaan after four decades of desert existence, they had to overcome the two Amorite kingdoms on the Medeba plateau and in Bashan. Under Moses' leadership, they also subdued the Midianites in order to consolidate their control over the Transjordanian region. The conquest of Canaan followed a course that in retrospect appears as though it had been planned by a brilliant strategist. Taking Jericho gave Israel control of its strategic plains, fords and roads as a base of operations. When Israel next gained control of the Bethel, Gibeon and the Upper Beth Horon region, she dominated the center of the north-south Palestinian ridge. Subsequently, she was able to break the power of the allied urban centers in separate campaigns south and north.

### 2. THE CENTRAL CAMPAIGN

The destruction of both Jericho and Ai led to a major victory against the Canaanites in the Valley of Aijalon—the "battle of the long day"—which then allowed Joshua to proceed against the cities of the western foothills.

Archaeological evidence for the conquest is mixed, in part because the chronological problems are unsolved. On the one hand, clay tablets containing cuneiform letters to the Egyptian court have been found at Tell el-Amarna

in Egypt from c. 1375 B.C. These mention bands of *Habiru* who threaten many of the cities of Palestine and create fear among the Canaanite inhabitants.

On the other hand, numerous towns were destroyed c. 1230 B.C. by unknown assailants, presumably the "Sea Peoples," but possibly including the Israelites as well. The Biblical chronology based on 1Ki 6:1 seems to demand an even earlier dating, near the end of the 15th century (see Introduction to Joshua: Historical Setting).

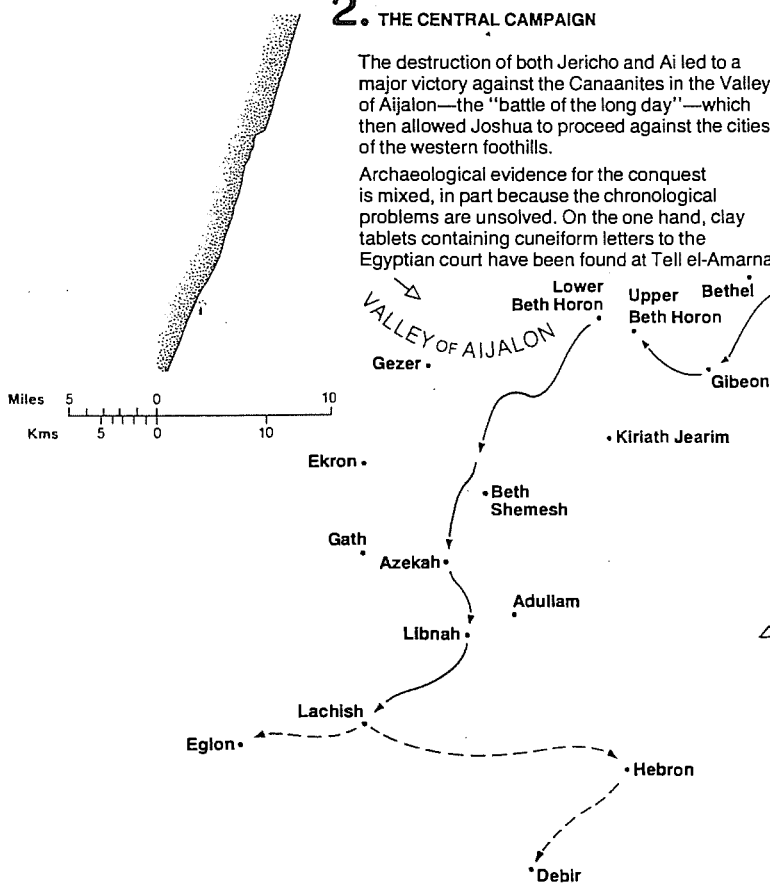

### 3. THE SOUTHERN CAMPAIGN

Lachish, Debir, Libnah, Eglon and Makkedah (a town near Beth Shemesh and Azekah, whose exact location is unknown) were all captured by Joshua in his attack on the lowland foothills controlling the approaches to the Judahite plateau. Several of these towns, most notably Lachish, contain destruction evidence that might possibly be correlated with the Israelite conquest, but with Jericho and Ai, the historical implications are not clear.

## Division of Canaan

Irving L. Jensen, *Jensen's Survey of the OT*, 140 (adapted based on Barry Beitzel, *Moody Atlas of Bible Lands*, 100)

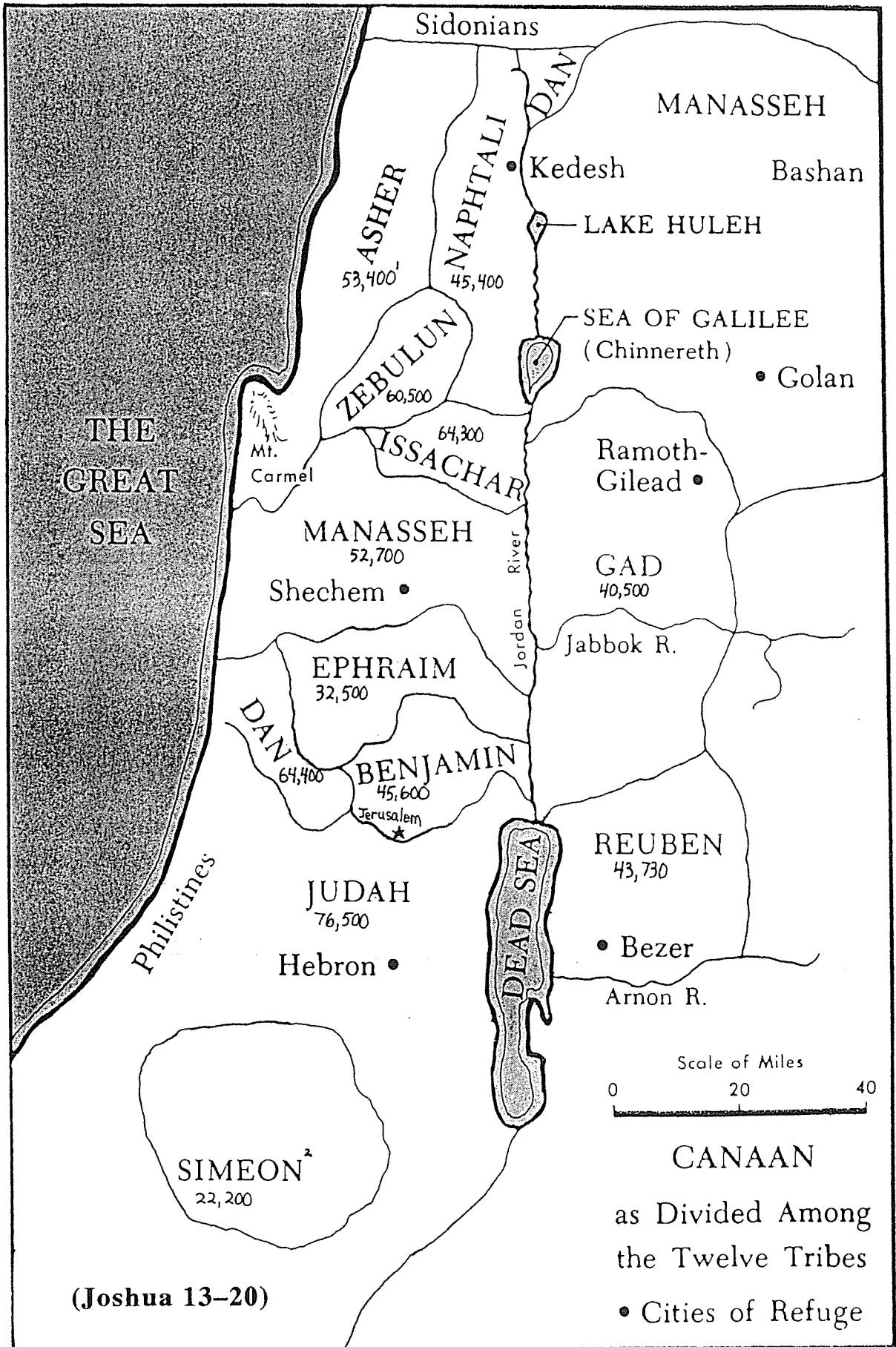

<sup>1</sup> Numbers for each tribe indicate the population of soldiers just before the conquest of Canaan (Num. 26).

<sup>2</sup> Simeon's inheritance lay within the land of Judah (Josh. 19:1-9) due to his violence at Shechem (Gen. 34:25-31). Levi also received no inheritance except cities within other tribes (cf. p. 171a) due to the same sin (Gen. 49:5-7).

# Levitic Cities and Cities of Refuge

Barry Beitzel, *Moody Atlas of Bible Lands*, 101

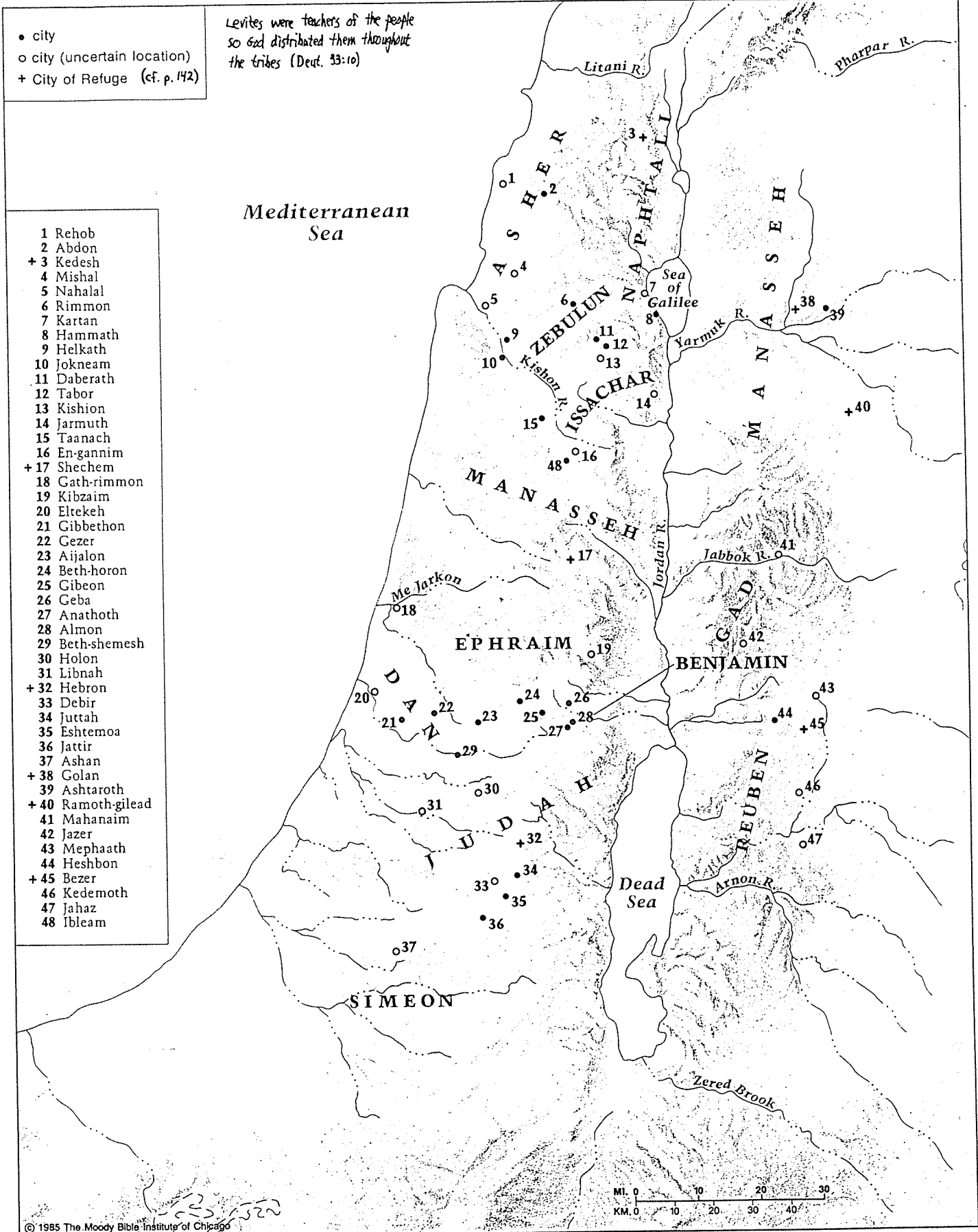

## Issues about Jericho

### 1. Is Jericho the Oldest City in the World?

Most archaeologists believe Jericho is the world's oldest city (8000 BC), even before pottery was made. However, the actual oldest city more probably would be Babylon in Iraq where the tower of Babel was built (Gen. 11). The genealogies of Genesis 5 and 11 at face value (no gaps) leads to creation at 4143 BC anyway (p. 84). A date of no later than 4000 BC for settlements on the site (not a full-fledged city) is supported by the excavations of British professor and archaeologist John Garstang. He unearthed five layers of cities at Jericho from 1930-1936 and published a definitive work in *The Story of Jericho* (London: Marshall, Morgan & Scott, 1940; rev. ed., 1948). However, either proposed date (8000 or 4000 BC) would precede the flood at about 2500 BC (p. 90).

### 2. What made Jericho so Significant?

Jericho's strategic location guards the pass to the hills of Judah and across the Jordan River, as well as the north-south route of the Jordan Valley. Due to this location, some believe Jericho has been built and destroyed 23 times! It is also called City of Palms (Deut. 34:3; "Jericho" means "fragrant place") as it lies in the fertile Jordan oasis rich in fruits and vegetation (not watered by rain). The OT site of Joshua 6 is Tell es-Sultan, a 400 meter mound arising 15 meters from the bedrock. Immediately to the east is the spring of Ain es-Sultan that waters the oasis. This is likely the fountain of Elisha (2 Kings 2:19-22). Behind Jericho is Jebel Kuruntul or Mount of Temptation where tradition records Christ's temptation by Satan for 40 days (Matt. 4; Luke 4).

### 3. Did God Bless Rahab's Lie?

Rahab actually lied in several ways. She said she didn't know where they men had come from, she said they had left, and she said she didn't know where they went (Josh. 2:4-5). Does the end (saving the lives of the spies) justify the means (lying)?

Several items can be said in response:

1. God never said that he approved of her lying. He only approved of her faith (Heb. 11:31).
2. God could have still saved the lives of the spies and Rahab even if she told the truth.
3. "At most, God allowed his purposes to be fulfilled in this unusual manner because his grace can operate in spite of the sinful maneuverings of man" (Kaiser, *Hard Sayings of the OT*, 97).



Frontispiece

*An Artist's Impression of the Fourth City of Jericho in the Time of Joshua (1400 BC)*  
This is how Israel saw the city from the east. Note the spring in front of the city as well as remains of the third city. Houses rose on the west side behind imposing walls with the king's palace in the middle and temple southwest.

#### 4. Is There Evidence that Jericho's Wall Collapsed?

John Garstang (see earlier) surveyed the evidence for the destruction of the fourth city (Layer D) and concluded it was destroyed by Joshua between 1426 and 1385 BC. He notes that about 100 years earlier Jericho had two walls constructed: a 12-foot thick inner wall of mud-brick, plus a 6-foot thick outer wall (pp. 135-36). The walls were so strong that overcrowding in the city motivated people to build homes bridging the two walls (Josh. 2:15). A field report reports evidence of burning (Josh. 6:24) in "reddened masses of brick, cracked stones, charred timbers and ashes" (p. 136). Ancient walls typically crumbled on themselves or towards a city from battering rams; yet note below in Garstang's cross-sectioned drawing how both walls fell *away* from the city:

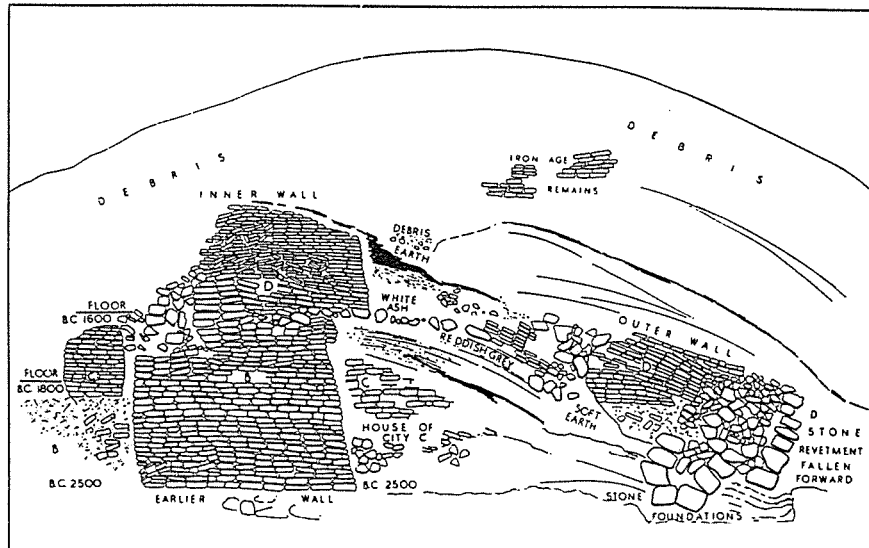

PLATE XVIII

THE FALLEN WALLS OF CITY IV (FROM A MEASURED DRAWING)

B. Brick wall of the Second City on the western scarp. DD. Walls of the Fourth City

“What then could account for so stupendous a catastrophe?” Garstang writes. He dismisses trampling of feet, a loud shout, trumpets, and tunneling—then concludes (p. 138):

One conclusion indeed seems certain: the power that could dislodge hundreds of tons of masonry in the way described must have been superhuman. Earthquake is the one and only known agent capable of the demonstration of force indicated by the facts; and there is reason to believe that in this lies the real answer to our question.

Garstang then cites a dozen earthquakes in this area from ancient to modern times.

These findings, of course, have found opponents in advocates of a late date exodus (1280 BC) such as G.E. Wright and W.F. Albright. Kathleen Kenyon (*Digging Up Jericho*, 1957) later advocated that the wall fell and the city was burnt at various times in its history (see J.A. Thompson, *The Bible and Archaeology*, 2d. ed., [Eerdmans, 1973], 60-61). Yet Garstang had noted that burning normally did accompany destructions, but the City D level was unusually large (p. 142), as would be expected when the city was not plundered first (Josh. 6:24). Finds include huge supplies of food.

#### 5. How Could a Loving God Command the Killing of Canaanites?

God told Israel to conquer Jericho and the Canaanite cities by not leaving anything alive that breathes (Deut. 20:16-17), so they killed men, women, babies, and animals (Josh. 6:21; 8:26; 10:28; 11:11). Yet in the NT we find God as a loving God. Jesus even said to turn the cheek towards violence (Matt. 5:39). How can we reconcile these seemingly contradictory commands?

1. God is always the same God. He is a God of love in the OT as seen in His many acts of grace; He is also a God of wrath in the NT (Rom. 1:18). He even waited 400 years until the sin of the Amorites (Canaanites) “reached its full measure” (Gen. 15:16)—that is, they bore their own sin.
2. God showed love to the world by protecting Israel and the world from Canaanite influences (Deut. 20:16-18), including their child sacrifice, homosexuality, bestiality, etc. (Benware, 276).
3. Only radical surgery can save bodies from cancer. Is such surgery inhumane (Gen. 6:5)?
4. We have resources against corruption that Israel lacked (Rom. 6:13; 1 Cor. 6:19; 2 Cor. 10:4-5).



# Judges

<b>Failure Under the Theocracy</b>										
<b>Incomplete Occupation</b>		<b>Deliverance by Judges</b>							<b>Need for Monarchy</b>	
1:1–2:5		2:6–16:31							17–21	
<b>Deterioration</b>		<b>Discipline</b>							<b>Depravity</b>	
<b>Causes of the Cycles</b>		<b>Curse of the Cycles</b>							<b>Conditions in the Cycles</b>	
<b>Living with the Canaanites</b>		<b>War with the Canaanites</b>							<b>Living Like the Canaanites</b>	
Military Disobedience 1	Spiritual Disobedience 2:1-5	Intro 2:6-3:6	South 3:5-3:31	North 4:1-5:31	Central 6:1-10:2	East 10:3-12:7	North 12:8-12:15	West 13:1-16:31	Religious Depravity 17-18	Moral Depravity 19-21
<b>Canaan</b>										
<b>c. 341 Years (1390-1049 BC)</b>										

**Key Word:** Failure

**Key Verse:** “In those days Israel had no king; everyone did as he saw fit [what was right in his own eyes]” (Judges 21:25)

**Summary Statement:**

*Israel's failure under the theocracy due to faithless disobedience is contrasted with God's merciful care in disciplining and delivering Israel through judges to exhort submission to its new, divinely appointed kings in a righteous monarchy.*

**Applications:**

Rejecting God’s lordship (incomplete obedience) plants the seeds for failure (1-2).

Personal relative standards instead of God’s absolute standards lead to cycles of sin (3-16).

Replacing God’s wisdom with personal whims ultimately leads to idolatry (17-21).

# Judges

## Introduction

- I. **Title** The name Judges ( $\mu\upsilon\phi\iota\pi$ ,  $v\theta$  *sop<sup>e</sup>tim*) refers to those who "act as law-giver, judge, governor" (BDB 1047b 1b). However, the book itself demonstrates that the term applies not only to those who *maintain* justice and settle disputes, but also liberate or *deliver* the people first before ruling and administering justice (2:16, 18).

### II. Authorship

- A. **External Evidence:** The Talmud (Tractate *Baba Bathra* 14b) ascribes to Samuel the books of Judges, Ruth, and Samuel.
- B. **Internal Evidence:** The author is anonymous, but the Jewish tradition regarding Samuel's authorship makes good sense for several reasons:
1. The repeated phrase "in those days Israel had no king" (17:6; 18:1; 19:1; 21:25) places the writing between the beginning of Saul's reign and the divided monarchy, which makes the earliest possible date at 1043 BC when Saul became king.
  2. The fact that the Jebusites still inhabited Jerusalem when the book was penned (1:21) places the latest possible date of writing before 1004 BC when David conquered the city (2 Sam. 5:5-9).

While other evidence can be cited, these two factors alone place the writing during the time of Samuel when Israel had a king (#1 above) and that king was either Saul or David (#2 above). Although a contemporary of Samuel could have reported this history, the Jewish tradition and fact that Samuel was a writer (1 Sam. 10:25) provide strong evidence that he wrote the book.

### III. Circumstances

- A. **Date:** The above information cites proof that Judges was written after the coronation of Saul (1043 BC) and before David's conquest of Jerusalem (1004 BC). Some critics feel this date is too early since a summation of the rules of each judge yields 410 years (too many years to fit between Joshua and Saul's times). However, due to overlapping judgeships, the events covered in the book span approximately 341 years (from about 1390 BC-1049 BC; cf. p. 96) and therefore end just before the time of the book's composition.
- B. **Recipients:** The early monarchy date reveals that the original readers of this historical account constitute the Jews who recently experienced the change from a theocracy to a monarchy.
- C. **Occasion:** Judges records life in Israel during the final days of the theocracy when the nation officially operated under the rule of God. However, in reality Israel did not submit to His authority since "everyone did as he saw fit," or more literally, "every man did what was right in his own eyes" (17:6; 21:25; NASB). That the oft mentioned motto "Israel had no king" is coupled with this anarchy statement in these two references indicates that the book may have been composed as a defense for the monarchy—that Israel needed to be united under the rule of a righteous king.

### IV. Characteristics

- A. In contrast to the *national* leadership of Moses and/or Joshua in the Pentateuch and Book of Joshua, Judges is the first book in the Old Testament to record leadership by judges who ruled on a *local* level.

B. Judges is similar to Numbers in that it also contrasts the faithful, patient love of God with the faithless, impatient ingratitude of Israel in cycles.

1. Pattern: This sin of Israel follows a cyclical pattern which occurs in a five stage progression from sin to servitude to supplication to salvation to silence, then back to sin again as the cycles repeat themselves seven times (see below).

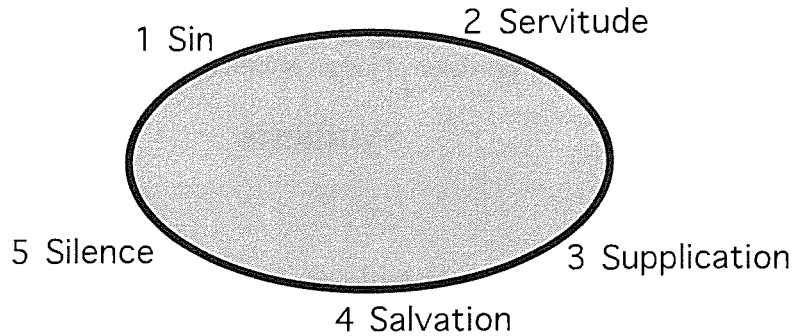

2. The Seven Cycles of the Book of Judges (see chronology on p. 96):

Cycle	Oppressor	Location in Israel	Years of Oppression	Deliverer	Years of Peace
1 (3:7-11)	Mesopotamians	South	8	Othniel	40
2 (3:12-30)	Moabites	Southeast	18	Ehud	80
Parenthesis (3:31)	Philistines	Southwest	—	Shamgar	—
3 (chs. 4–5)	Canaanites	North	20	Deborah & Barak	40
4 (6:1–8:32)	Midianites	Northcentral (Ophrah)	7	Gideon	40
5 (8:33–9:57)	Abimelech	Central	3	Unnamed Woman	—
Parenthesis (10:1-2)	—	Central (Shamir)	—	Tola	23
Parenthesis (10:3-5)	—	East (Komon, Gilead)	—	Jair	22
6 (10:6–12:7)	Ammonites	East (Zaphon, Gilead)	18	Jephthah	6
Parenthesis (12:8-10)	—	Southeast (Bethlehem)	—	Ibzan	7
Parenthesis (12:11-12)	—	Northwest	—	Elon	10
Parenthesis (12:13-15)	—	Central (Pirathon)	—	Abdon	8
7 (chs. 13–16)	Philistines	Southwest (Zorah)	40	Samson	20

## Argument

The repeated phrase "in those days Israel had no king" (17:6; 18:1; 19:1; 21:25) provides the key to unlocking the argument of Judges. The book chronicles the failure of the theocracy in the political and religious failure of the nation (1:1—2:5), the successive attempts of twelve judges to provide stability to the theocracy (2:6—16:31), and the complete spiritual and moral collapse of the nation (chs. 17—21). One may note that the four occurrences of the lack of a king (above) appear only in this third section of the book as evidence of the need for a righteous monarchy to replace the failed theocracy explained in the first sixteen chapters. Throughout the account God's merciful care contrasts sharply with the disobedience of His wayward people. The provision of judges is cited as an act of God's compassion (2:16, 18).

## Synthesis

### Failure of the theocracy

<b>1:1—2:5</b>	<b>Incomplete occupation/obedience</b>
1	Military
2:1-5	Spiritual
<b>2:6—16:31</b>	<b>Deliverance by Judges</b>
2:6—3:6	Introduction
3:7—16:31	12 Judges, 7 cycles
3:7-11	Othniel
3:12-31	Ehud
3:31	Shamgar
4—5	Deborah/Barak
6:1—8:28	Gideon
8:29—9:57	Unnamed woman
10:1-2	Tola
10:3-5	Jair
10:6—12:7	Jephthah
12:8-10	Izban
12:11-12	Elon
12:13-15	Abdon
13—16	Samson
<b>17—21</b>	<b>Need for Monarchy</b>
17—18	Religious failure
17	Micah's priest
18	Danite migration
19—21	Moral failure
19	Levite concubine disaster
20	Benjamites almost destroyed
21	Wives provided
21:25	Monarchy needed

## Outline

### Summary Statement for the Book

*Israel's failure under the theocracy* due to faithless disobedience is contrasted with God's merciful care in disciplining and delivering Israel through judges to exhort submission *to its new, divinely appointed kings* in a righteous monarchy.

- I. (1:1—2:5) Israel's political failure of incomplete occupation of Canaan results in a religious failure of incomplete obedience as an introduction to the failure of the theocracy and the need for Israel's deliverance.

- A. (Ch. 1) Israel's political-military failure to complete the conquest indicates that as a whole the tribes did not obey the LORD by exercising faith in God to claim His promise of the entire land.
  - B. (2:1-5) Israel's religious-spiritual failure resulting from the incomplete conquest is a breaking of the covenant by alliances and idolatry which the pre-incarnate Christ vows would snare them to teach the need for deliverance and the cost of incomplete obedience.
- II. (2:6—16:31) Israel's deliverance by God through twelve judges who seek to avert its seven cycles of sin demonstrates God's merciful care despite Israel's failure during the theocracy.**
- A. (2:6—3:6) The introduction to the twelve judges previews God's repeated provision of judges to deliver Israel from the remaining nations even though it breaks the covenant after the death of Joshua.
  - B. (3:7—16:31) Israel's deliverance through twelve judges during its downward moral spiral in seven cycles shows God's merciful provision each time the people turn from idols back to Him to teach the nation that God cannot be blamed for the failure of the theocracy.
    - 1. (3:7-11) Cycle 1: Othniel (Caleb's nephew) delivers southern Israel from the Mesopotamians as God's merciful provision for the nation after it turns from idols to the LORD.
      - a. (3:7) Sin: Israel does evil by forgetting the LORD and serving the Baals and Asherahs.
      - b. (3:8) Servitude: God punishes the nation's idolatry through the oppression of Cushan-Rishathaim, King of Mesopotamia, for eight years.
      - c. (3:9a) Supplication: The nation cries out to the LORD for deliverance from its enemies.
      - d. (3:9b-10) Salvation: Othniel (Caleb's nephew) delivers southern Israel from the Mesopotamians as God's merciful provision for the nation.
      - e. (3:11) Silence: The nation experiences peace for forty years until Othniel dies.
    - 2. (3:12-30) Cycle 2: Ehud delivers southeastern Israel from the Moabites by killing the fat King Eglon as God's merciful provision for the nation after it turns from idols to the LORD.
      - a. (3:12a) Sin: Israel again does evil before the LORD.
      - b. (3:12b-14) Servitude: God punishes the nation's disobedience through the oppression of King Eglon of Moab for eighteen years.
      - c. (3:15a) Supplication: The nation cries out to the LORD for deliverance from its enemy.
      - d. (3:15b-29) Salvation: Ehud delivers southeastern Israel from the Moabites by killing the fat King Eglon as God's merciful provision for the nation.
      - e. (3:30) Silence: The nation experiences peace for eighty years.
    - (3:31) Shamgar delivers southwestern Israel from the Philistines by killing six hundred men as God's merciful provision for the nation during the lifetime of Ehud.
    - 3. (Chs. 4—5) Cycle 3: Deborah and Barak deliver northern Israel from the Canaanites and sing a song of victory as God's merciful provision for the nation after it turns from idols to the LORD.
      - a. (4:1) Sin: Israel again does evil before the LORD.

- b. (4:2-3a) Servitude: God punishes the nation's disobedience through the oppression of Jabin, a king of Canaan, for twenty years.
  - c. (4:3b) Supplication: The nation cries out to the LORD for deliverance from its enemies.
  - d. (4:4—5:31a) Salvation: Deborah and Barak deliver northern Israel from the Canaanites and sing a song of victory as God's merciful provision for the nation.
  - e. (5:31b) Silence: The nation experiences peace for forty years.
4. (6:1—8:32) Cycle 4: Gideon delivers northcentral Israel from the Midianites as God's merciful provision for the nation after it turns from idols to the LORD.
- a. (6:1a) Sin: Israel again does evil before the LORD.
  - b. (6:1b-6) Servitude: God punishes the nation's disobedience through the oppression of the Midianites, Amalekites, and other eastern peoples who ravage the land for seven years.
  - c. (6:7-10) Supplication: The nation cries out to the LORD for deliverance from its enemies.
  - d. (6:11—8:27) Salvation: Gideon delivers northcentral Israel from the Midianites as God's merciful provision for the nation.
    - 1) (6:11-40) The pre-incarnate Christ calls, tests, empowers, and encourages Gideon to lead Israel against the Midianites, Amalekites, and other eastern peoples.
      - a) (6:11-24) Gideon is called to the task of leading Israel.
      - b) (6:25-32) Gideon is tested in his ability to obey the LORD through his destruction of Baal's altar.
      - c) (6:33-35) Gideon is empowered for service as the Midianites, Amalekites, and other eastern peoples camp opposite Israel for war.
      - d) (6:36-40) Gideon is encouraged by God in the confirmation of his call through a wet and dry fleece.
    - 2) (7:1—8:21) Gideon delivers northcentral Israel from the Midianites as God's merciful provision for the nation according to His promise to protect His people when they are obedient.
    - 3) (8:22-27) Gideon judges the people foolishly by making a golden ephod which the people worship.
  - e. (8:28-32) Silence: The nation experiences peace for forty years.
5. (8:33—9:57) Cycle 5: An unnamed woman delivers central Israel from Abimelech's vicious rule of fellow Israelites as God's merciful provision for the nation even though it never turns from idols to the LORD.
- a. (8:33-35) Sin: Israel sins against the LORD by prostituting itself before the Baals.
  - b. (9:1-49) Servitude: The nation's breaking of the covenant allows oppression by one of its own—Gideon's son Abimelech—who usurps his father's desire for God's rulership by murdering sixty-nine of his half-brothers (all except Jotham).

- c. (Absent) Supplication: No mention is made of Israel ever requesting God for deliverance from Abimelech.
  - d. (9:50-57) Salvation: Though not specifically designated a judge, an unnamed woman of Thebez delivers Israel from Abimelech by killing him with a millstone in Shechem.
  - e. (Absent) Silence: Since no judge delivers Israel from Abimelech no rulership is recorded and the account continues with Tola.
- (10:1-2) Tola delivers central Israel from unrevealed oppressors as God's merciful provision for the nation.
  - (10:3-5) Jair leads eastern Israel as God's merciful provision for the nation.
6. (10:6—12:7) Cycle 6: Jephthah delivers eastern Israel from the Ammonites as God's merciful provision for the nation after it turns from idols to the LORD.
- a. (10:6) Sin: Israel sins against the LORD by serving the gods of many nations.
  - b. (10:7-9) Servitude: The nation's breaking of the covenant in Gilead causes them to be oppressed by the Philistines and Ammonites for eighteen years.
  - c. (10:10-16) Supplication: The people cry out to God in repentance and rid themselves of idols.
  - d. (10:17—12:6) Salvation: Jephthah delivers eastern Israel from the Ammonites as God's merciful provision for Israel but fulfills a foolish vow by executing his daughter and executes 42,000 Ephraimites for their jealousy over his victory.
- \* For views on the fate of Jephthah's daughter, see page 183.
- e. (12:7) Silence: Jephthah rules the land for six years.
  - (12:8-10) Izban leads southeastern Israel as God's merciful provision for the nation.
  - (12:11-12) Elon leads northwest Israel as God's merciful provision for the nation.
  - (12:13-15) Abdon leads central Israel as God's merciful provision for the nation.
7. (Chs. 13—16) Cycle 7: Samson delivers southwestern Israel from the Philistines as God's merciful provision for the nation even though it never turns from evil to God.
- a. (13:1a) Sin: Israel again does evil before the LORD.
  - b. (13:1b) Servitude: God punishes the nation's disobedience through the oppression of the Philistines for forty years.
  - c. (Absent) Supplication: No mention is made of the nation crying out to the LORD for deliverance from its enemy.
  - d. (13:2—16:31) Salvation: Samson delivers southwestern Israel from the Philistines as God's merciful provision for the nation.
    - 1) (13:2-25) The miraculous events surrounding Samson's birth indicate him as God's merciful provision for the nation.
    - 2) (Ch. 14) Samson kills thirty Philistines after being deceived at his sinful wedding feast with a Philistine woman as God's agent for vengeance against the Philistines.

- 3) (Ch. 15) Once again as God's agent for vengeance against the Philistines, Samson burns their fields for giving his wife to his wedding attendant and kills one thousand Philistines after the murder of her and her father.
  - 4) (Ch. 16) In Samson's downfall by succumbing to Delilah's nagging he dies with three thousand Philistines as his final act of vengeance upon Israel's enemy.
- e. (Absent) Silence: No mention is made of the nation experiencing peace after Samson's twenty year rule.

### III. (Chs. 17–21) Israel's religious and moral failures portrayed through two Levites demonstrate the need for a righteous monarchy to replace the failed theocracy.

- A. (Chs. 17–18) The religious failure of the people seen in the hiring of a Levite pagan priest who blesses Dan's ungodly migration is recorded as evidence of the need for a righteous monarchy to replace the failed theocracy.
1. (Ch. 17) Micah's idolatry and hiring of a Levite as pagan priest exemplifies the personal religious apostasy in Israel to show the need for a righteous monarchy to replace the failed theocracy.
  2. (Ch. 18) The Levite's godless blessing upon the selfish and faithless migration plan of the Danites reveals the tribal religious apostasy in Israel to show the need for a righteous monarchy to replace the failed theocracy.
- B. (Chs. 19–21) The moral failure of the people in the Benjamite murder of a Levite's concubine and the national retaliation is recorded as evidence of the need for a righteous monarchy to replace the failed theocracy.
1. (Ch. 19) Benjamites in Gibeah rape and kill the concubine of a Levite traveling through their area, who then cuts her into twelve pieces and sends one to each tribe in Israel—an illustration of the rampant immorality in the failed theocracy.
  2. (Ch. 20) The 400,000 warriors of the other eleven tribes destroy in three days 26,100\* of the 26,700 Benjamite soldiers in addition to all the women and children, thus nearly destroying the entire tribe except 600 men who fled into the desert.
- \* The 25,100 killed (20:35) excludes 1000 Benjamites killed on days 1 & 2 of battle.
3. (21:1-24) Israelites preserve the tribe of Benjamin by providing wives for the 600 living Benjamites through killing everyone in Jabesh Gilead except 400 virgins and stealing 200 virgins at a festival at Shiloh—both godless attempts to undo their wrong.
  4. (21:25) The closing statement of relativism as the people's ethical standard reiterates the moral failure of the people to indicate the need for a righteous monarchy to replace the failed theocracy.

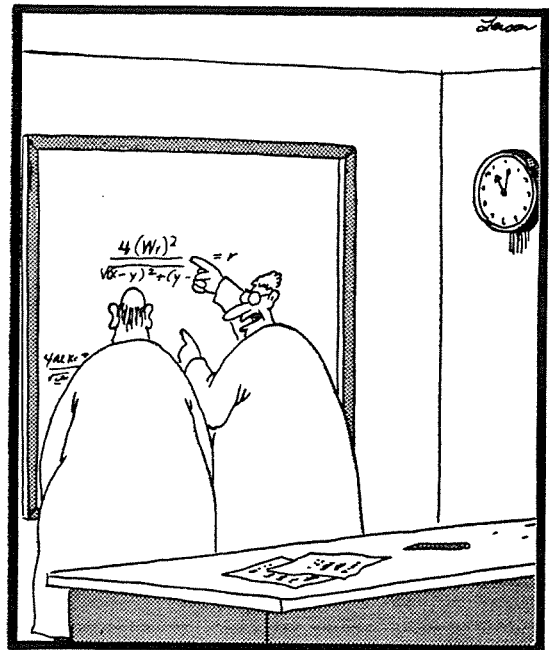

"Yes, yes, I know that, Sidney ... everybody knows that! ... But look: Four wrongs squared, minus two wrongs to the fourth power, divided by this formula, do make a right."



## Joshua and Judges Contrasted

Based on Thomas L. Constable, "A Theology of Joshua, Judges, and Ruth," in *A Biblical Theology of the Old Testament* (ed. Roy B. Zuck), 107, and *TTTB*, 61

	<b>Joshua</b>	<b>Judges</b>
<i>Leadership Transition</i>	Moses disciplined Joshua	Joshua disciplined No-one
<i>Tone</i>	Positive	Negative
<i>People's Faith to God</i>	Faithfulness	Faithlessness
<i>People's Obedience</i>	Obedience	Disobedience
<i>Battle Results</i>	Victory	Defeat
<i>Overall Results</i>	Success	Failure
<i>Growth</i>	Progress	Retrogression
<i>God's Attributes</i>	Hatred of Sin	Grace towards Sinners
<i>Idolatry</i>	Destroyed Idols	Worshipped Idols
<i>Community</i>	Unity	Tribal Hostility
<i>Response to the Law</i>	Regard	Abandonment (18:24-25)
<i>Values</i>	Transmitted	Didn't know the LORD (2:10)
<i>Authority for Living</i>	Absolute	Relative (17:6; 21:25)
<i>Morality</i>	Objective	Subjective
<i>Slavery</i>	Freedom	Bondage
<i>Servitude</i>	Served God (24:31)	Served Self (21:25)
<i>Attitude towards Sin</i>	Judged	Tolerated
<i>Theocracy</i>	Strengthened	Declined
<i>Pattern of Life</i>	Linear & Upward	Cycles leading Downward

# The Judges According to Their Tribes

Yohanan Aharoni and Michael Avi-Yonah, *The MacMillan Bible Atlas*, 57

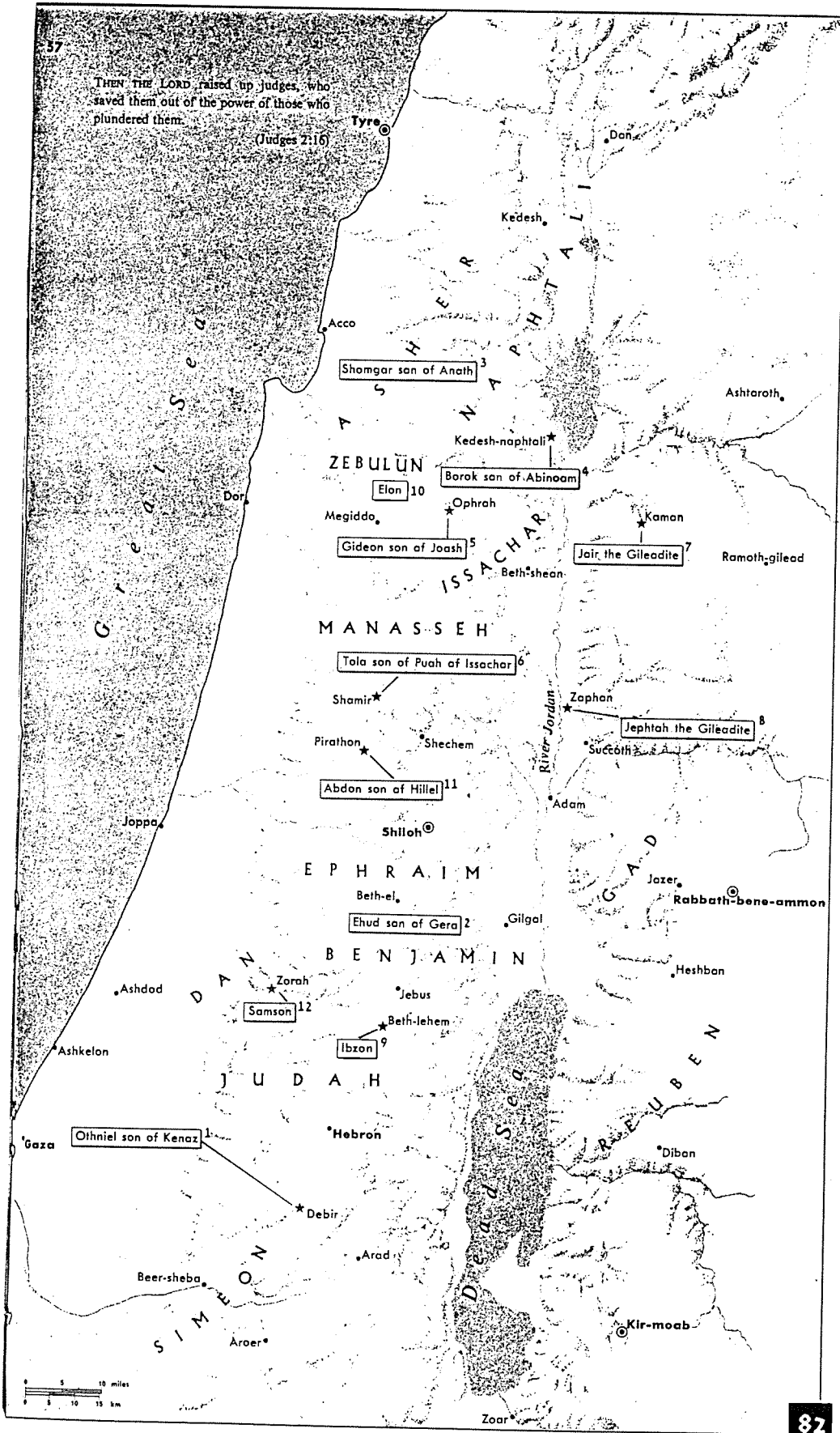

THE JUDGES ACCORDING TO THEIR TRIBES 12TH-11TH CENTURIES B.C.



Decorated Philistine jug

BESIDES the great Judges of deliverance, the Book of Judges also mentions several "minor Judges" (Judg. 10:1-5; 12:8-15), who judged the people from their native cities. Their wealth is usually emphasized in the Scriptures, and no tradition concerning wars under their leadership has come down to us. The tribal league (or possibly two leagues) may have been led by Judges, the position passing from tribe to tribe in rotation. In times of peace, their authority was quite limited. Five "minor Judges" are given and it may be more than incidental that the total number of Judges mentioned in the Book of Judges is twelve, a Judge for each tribe. It is doubtful whether these were the only "minor Judges"; their names may have been chosen on the basis of their tribal affiliations, in order to provide each tribe with a Judge, even if not a deliverer.

nearly every narrative block within the main body. These stereotyped formulae suggest that a narrator skillfully wove the accounts together for the purpose of making a theological point.

Within the main body of the book, seven major narrative blocks can be noted. Moreover, there are certain parallel features between these narratives so that the entire book reflects a carefully worked symmetrical pattern.<sup>10</sup> Furthermore this pattern has as its focal point the Gideon narrative in 6:1-8:32.<sup>11</sup>

- A Introduction, Part I (1:1-2:5)
- B Introduction, Part II (2:6-3:6)
- C Othniel Narrative (3:7-11)
- D Ehud Narrative (3:12-31)
- E Deborah-Barak Narrative (4:1-5:31)
- F Gideon Narrative (6:1-8:32)
- E' Abimelech Narrative (8:33-10:5)
- D' Jephthah Narrative (10:6-12:15)
- C' Samson Narrative (13:1-16:31)
- B' Epilogue, Part I (17:1-18:31)
- A' Epilogue, Part II (19:1-21:25)

This arrangement suggests that the Gideon narrative has a unique contribution to make to the theological development of the book. As the nation went from one cycle of discipline to the next, there was a continual deterioration. Also there was a shift in the "quality" of the judges themselves as the book advances. The Gideon narrative seems to mark a notable turning point.

### The Structure of the Gideon Narrative

An examination of the Gideon narrative reveals 20 episodes. They yield no significant evidence of inner-episodal textual patterning, but there is ample evidence of inter-episodal textual patterning, that is, patterning based on relationships between the episodes.<sup>12</sup> The episodes tend to group together in clusters in which two or three

<sup>10</sup> Credit goes to D. W. Gooding, "The Composition of the Book of Judges," *Eretz Israel* 16 (1982): 70-79, for the identification of this overall scheme (though this writer disagrees with the structure Gooding suggests for the Gideon narrative). For elaboration of the paralleling themes and motifs, see Barry G. Webb, *The Book of Judges: An Integrated Reading*, JSOT Supplement Series 46 (Sheffield: JSOT Press, 1987).

<sup>11</sup> For a different concept of the structure of Judges, see Dale Sumner DeWitt, "The Jephthah Traditions: A Rhetorical and Literary Study in the Deuteronomistic History" (PhD diss., Andrews University, 1987). DeWitt locates the center of the book with the Jephthah narrative, partly by reason of the lists of "minor judges" that frame the Jephthah narrative. For a discussion and refutation of this position, see this writer's "Textual Patterning," 222-28.

<sup>12</sup> See Tanner, "Textual Patterning," 147-99, for a detailed analysis of Judges 6-8.

episodes share a bonding between them on the basis of a common motif, a repeated phrase, an inclusio, or some other grammatical or syntactical feature that tends to set them off from other episodes. This technique of *episode bonding* is found throughout the narrative, resulting in eight episode clusters. Furthermore, when these clusters are examined from an even broader perspective, a pairing of episode clusters can be discerned. The result is that for the four episodes in 6:11-32, an alternation pattern of the type A B A' B' is found. For the six episodes in 6:33-7:18, a concentric pattern of the type A B C C' B' A' is found. For the six episodes in 7:19-8:21, an alternation pattern of the type A B C A' B' C' is noted.

The result is an overall division of the Gideon narrative into five primary sections. Furthermore, though these sections are derived on the basis of textual patterning, they accord perfectly with the contents of the narrative. The first section (6:1-10) provides the introduction and setting before Gideon's debut, the second section (6:11-32) gives the commissioning of Gideon as deliverer of Israel, the third section (6:33-7:18) presents the preparation for the battle, the fourth section (7:19-8:21) recounts the defeat of the Midianite army, and the fifth section (8:22-32) records the conclusion to Gideon's life after the victory over Midian. Yet thematic parallels exist between the first and fifth sections and between the second and fourth sections, thus giving the whole narrative a symmetrical pattern:<sup>13</sup>

- A 6:1-10
- B 6:11-32
- C 6:33-7:18
- B' 7:19-8:21
- A' 8:22-32

Sections A and A' have thematic connections with one another, and both have a simple A B pattern. Sections B and B' have thematic connections, and both have an alternation pattern. The remaining section C has a unique structure of its own with a concentric arrangement. Thus the overall structural pattern for the Gideon narrative highlights the middle section, 6:33-7:18.

### Implications of the Structural Pattern of Judges

#### THE ORGANIZING PRINCIPLE OF SYMMETRY

Examining the Book of Judges through the structural approach of textual patterning leads to two observations. The first is that the book as a whole is structured in a symmetrical inversion pattern with

<sup>13</sup> For documentation, see Tanner, "Textual Patterning," 188-99.

its focal point being the Gideon narrative in chapters 6-8. The second is that the Gideon narrative itself is also structured in a symmetrical inversion pattern, with its focal point being 6:33-7:18. Significantly the same type of structuring technique that characterizes the book as a whole characterizes the Gideon narrative itself. Associations between sections based on thematic parallels constitute the organizing principle for the symmetrical arrangements. The patterns underlying these two observations can be superimposed as follows:

- A Introduction, Part I  
 B Introduction, Part II  
 C Othniel  
 D Ehud  
 E Deborah-Barak  
 F Gideon  
 G Abimelech  
 H Jephthah  
 I Samson  
 J Epilogue, Part I  
 K Epilogue, Part II
- a Introduction to Gideon  
 b Call to Deliver  
 c Gideon's Personal Struggle to Believe God's Promise  
 b' Effecting of Deliverance  
 a' Conclusion to Gideon

#### GIDEON AS THE TURNING POINT IN JUDGES

In relation to the book as a whole, Gideon receives attention as the focal point because he represents a significant shift in the "quality" of the judges that served Israel. A progressive deterioration begins with Othniel and continues through Samson.<sup>14</sup> Othniel was almost an idealized judge, and Samson was a debauched self-centered individual. God used each judge, whether strong or weak, to accomplish His sovereign will and effect deliverance for the theocratic nation.<sup>15</sup> Gideon, on the other hand, stands somewhere be-

<sup>14</sup> Jobling has also noticed that judgeship initially appears positive but then becomes more and more negative. "The section begins with the judge-system in place and working (Othniel). Then, and with increasing pervasiveness, problems with the system are permitted to appear; rule by the judges fails to conform to expectations" (*The Sense of Biblical Narrative: Structural Analyses in the Hebrew Bible II*, 60). Jobling then lists four evidences of this negative trend. J. Cheryl Exum also observes that all the judges except Othniel make for unlikely heroes and that some of these leaders exhibit highly questionable behavior ("The Centre Cannot Hold: Thematic and Textual Instabilities in Judges," *Catholic Biblical Quarterly* 52 [July 1990]: 412). Cf. Webb, *The Book of the Judges: An Integrated Reading*, 157-58, 170-71.

<sup>15</sup> Abimelech is obviously an exception in that he did not deliver the Israelites from a foreign power. Yet as a leader, he demonstrates the dangers of dynastic kingship when power is placed in the hands of an ungodly individual.

tween these two extremes and represents the primary turning point from the "better" judges to the "weaker" ones.<sup>16</sup>

*The Othniel, Ehud, and Deborah-Barak narratives.* Othniel, the first judge, delivered Israel from Cushan-rishathaim of Mesopotamia. This is recorded in a concise, straightforward manner (3:7-11). The text neither mentions nor hints at flaws in his character, and the passage seems to illustrate perfectly the divine principle for dealing with the theocratic nation that had been delineated in the second introduction in 2:11-23. Furthermore Othniel came on the scene already a hero figure, because he had been previously introduced in 1:11-15 as a relative of the valiant Caleb who captured Debir (also known as Kiriath-sepher). Of possible significance is the fact that Othniel arose from the tribe of Judah. The second judge, Ehud, was left-handed and a man of the tribe of Benjamin and is seen in a positive light. Barak was a valiant warrior and led Israel to a mighty triumph over the forces of Jabin, king of Canaan, but his record is slightly tainted by his hesitation to follow the divine orders given through Deborah, a mistake for which he was deprived of the honor of capturing the enemy commander in battle (4:8-9).

*The Gideon Narrative.* With Gideon, the accounts of the judges become more complex. Whereas the Othniel account is very brief, the next two (Ehud and Deborah-Barak) are progressively longer. In comparison, the Gideon narrative is significantly longer, and this remains the governing principle for the rest of Judges.<sup>17</sup> The Gideon narrative also reflects greater complexity in that there is more elaboration on him as a person and more negative notes in the account. At the same time, the Gideon narrative marks a shift in the deteriorating condition of the nation in its relationship to Yahweh, in that He dealt more firmly with the nation. Though the familiar refrain "the sons of Israel did what was evil in the sight of the Lord" is given in 6:1, the Gideon narrative is not simply one more cycle of apostasy on par with the previous ones. The nation's apostasy had reached a lower point, and this is underscored by the additional fact that the Lord sent an unnamed prophet to rebuke them (6:7-10) *before*

<sup>16</sup> Exum has made a similar observation: "Although no neatly progressive pattern emerges, a turning-point occurs with Gideon. Gideon and the important figures after him reveal disturbing weaknesses, if not serious faults" ("The Centre Cannot Hold: Thematic and Textual Instabilities in Judges," 412). In chapter 7 of his dissertation, L. G. Stone has demonstrated how "compared with the Othniel account, the judges following him form a clear three-step decline from triumphant judges (3:12-5:31) through a transitional figure, Gideon (6:1-8:28), to the 'tragic' judges (10:6-16:31)" (see abstract of "From Tribal Confederation to Monarchic State: The Editorial Perspective of the Book of Judges" [PhD diss., Yale University, 1988]).

<sup>17</sup> The Abimelech account is somewhat of an exception to this trend, though the principle is still true if it is recognized that Abimelech is an extension in one sense of the Gideon narrative.

# Enemies in Canaan During the Judges

Irving L. Jensen, *Jensen's Survey of the Old Testament*, 155

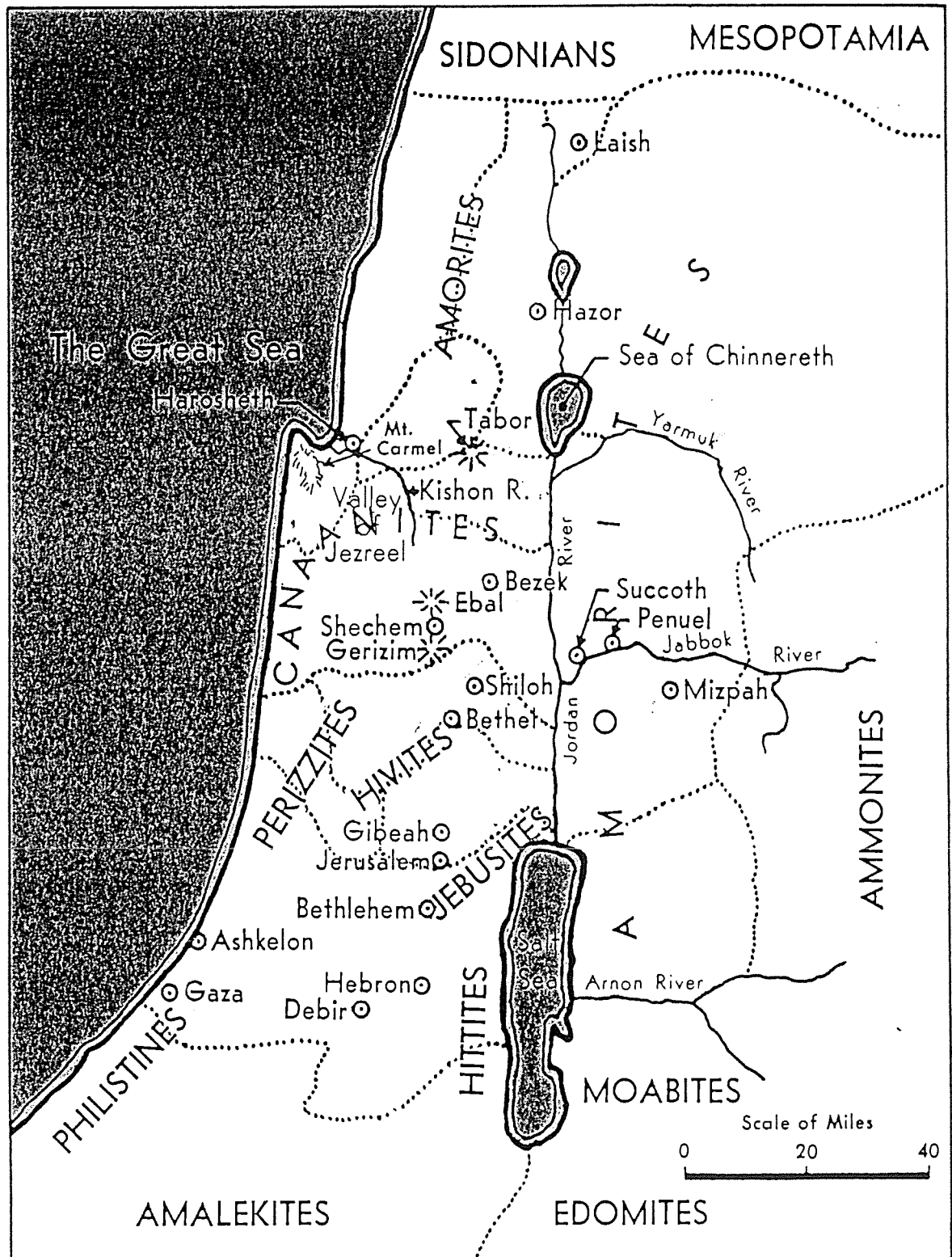

# Five Cities of the Philistines and Gideon's Battles

The Bible Visual Resource Book, 49

## Judges

### Five Cities of the Philistines

Like a string of opulent pearls along the Mediterranean coast, the five cities of the Philistines comprise a litany of familiar Biblical names: Gaza, Ashkelon, Ashdod, Ekron and Gath.

Each was a commercial emporium with important connections reaching as far as Egypt along the coastal route, the "interstate highway" of the ancient world. The ships of Phoenicia, Cyprus, Crete and the Aegean called at Philistia's seaports, which included a site today called Tell Qasile, where a Philistine temple has been found, on the Yarkon River just north of modern Tel Aviv.

The Philistine plain itself was an arid, loess-covered lowland bordering on the desert to the south—a stretch of undulating sand dunes adjacent to the sea—and the foothills of the Judahite plateau on the east. No area in Biblical history was more frequently contested than the western foothills (the Shephelah region), lying on the border between Judea and Philistia. Beth Shemesh, Timnah, Azekah and Ziklag were among the towns coveted by both Israelites and Philistines, and they figure in the stories of Samson, Goliath and David.

The area to the north of Philistia, the plain of Sharon, was also contested at various periods: During Saul's reign the Philistines even held Beth Shan and the Esdraelon valley. Later, from about the time of Baasha on, a long border war was conducted by the Israelites at Gibbethon. Originally a part of Judah's tribal allotment, the coastal area was never totally wrested away from the Philistines who may have begun their occupation as early as the time of Abraham.

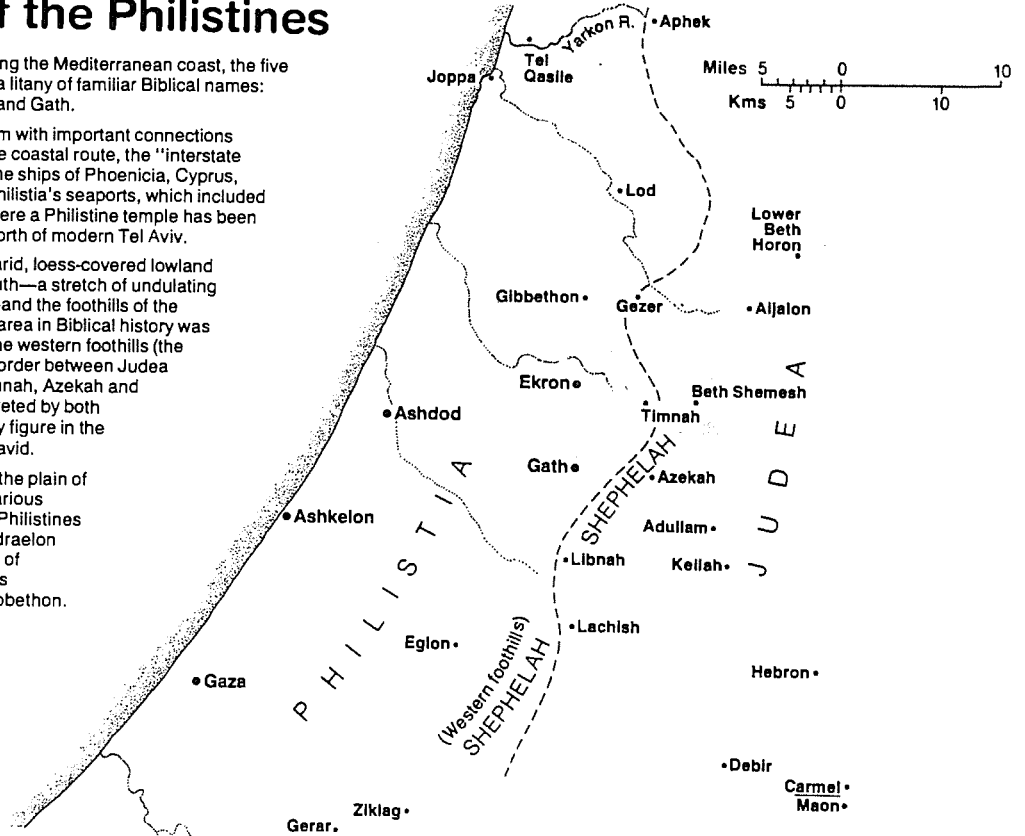

### Gideon's Battles

The story of Gideon begins with a graphic portrayal of one of the most striking facts of life in the Fertile Crescent: the periodic migration of nomadic people from the Aramean desert into the settled areas of Palestine. Each spring the tents of the *bedouin* herdsmen appear overnight almost as if by magic, scattered on the hills and fields of the farming districts. Conflict between these two ways of life (herdsmen and farmers) was inevitable.

In the Biblical period, the vast numbers and warlike practice of the herdsmen reduced the village people to near vassalage. Gideon's answer was twofold: (1) religious reform, starting with his own family; and (2) military action, based on a coalition of northern Israelite tribes. The location of Gideon's hometown, "Ophrah of the Abiezrites," is not known with certainty, but probably was ancient Aper (modern Afula) in the Valley of Jezreel.

The battle at the spring of Harod is justly celebrated for its strategic brilliance. Denied the use of the only local water source, the Midianites camped in the valley and fell victim to the small band of Israelites, who attacked them from the heights of the hill of Moreh.

The main battle took place north of the hill near the village of Endor at the foot of Mount Tabor. Fleeing by way of the Jordan Valley, the Midianites were trapped when the Ephraimites seized the fords of the Jordan from below Beth Shan to Beth Barah near Adam.

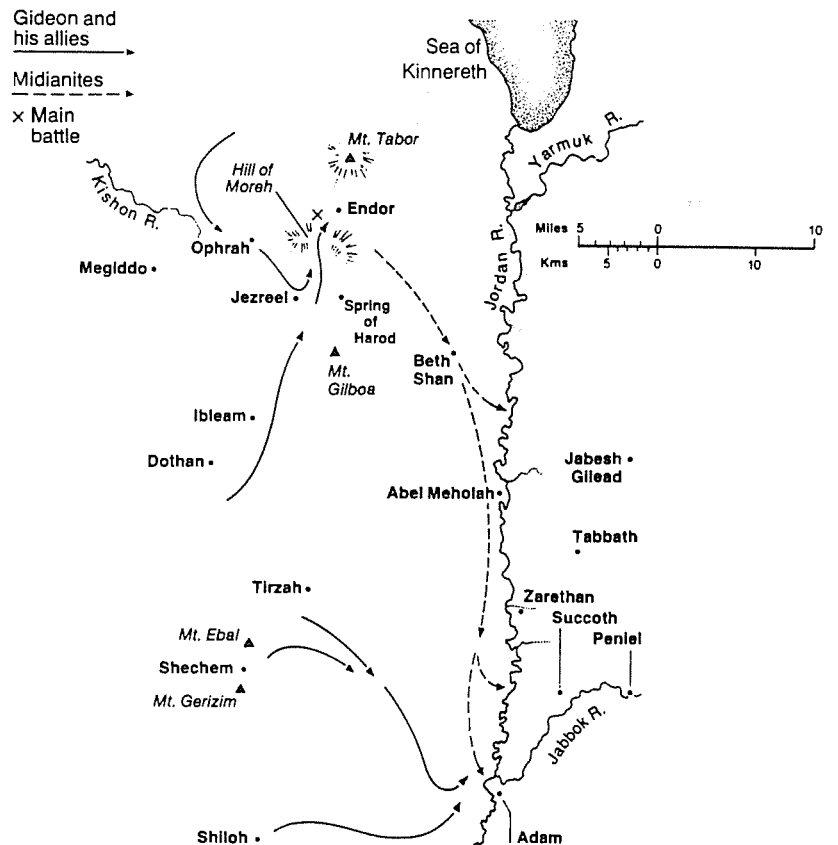

## Views on Jephthah's Daughter (Judg. 12)

John H. Walton, *Chronological and Background Charts of the OT*, 2d ed., 104

DEDICATED	SACRIFICED
1. Being a judge, Jephthah must have been God-fearing, so he would not have violated Law	<b>1. Promise of a simple animal sacrifice would hardly be a convincing vow in this situation</b>
<b>2. The Spirit of the Lord comes on Jephthah and he is mentioned in Heb. 11 so he would not have violated Law</b>	2. The mention of something coming out of the house implies that human sacrifice was intended
3. Daughter bewails her virginity and 11:39 makes comment that "she knew not a man"	<b>3. The burnt offering ('olah) involves death in all 286 O.T. occurrences</b>
<b>4. Evidence of women in service of tabernacle—Ex. 38:8; I Sam. 2:22</b>	4. If it was frequent practice to have women enter tabernacle service, why the commemoration?
5. Human sacrifice would have been clearly understood as a violation of God's Law, and public opinion would have disallowed it even if Jephthah wanted to proceed	<b>5. Human sacrifice is seen as a last ditch effort in battle (2 Kings 3:27)</b>
<b>6. Lev. 27:1-8 allows for redemption of humans vowed for sacrifice</b>	6. The conjunction in 11:31 is one of apposition: "will be the Lord's, that is I will sacrifice it as a burnt offering"
7. The conjunction in 11:31 should be rendered or, showing Jephthah considered various situations	<b>7. There is little evidence of Jephthah's spirituality or knowledge of the Law</b>

## WHAT IS SIN?

### Man calls it ...

an accident

a blunder

a defect

a chance

an error

a fascination

an infirmity

a luxury

liberty

a trifle

a mistake

a weakness

### God calls it ....

an abomination

a blindness

a disease

a choice

an enmity

a fatality

an iniquity

a leprosy

lawlessness

a tragedy

a madness

a willfulness

*Moody Monthly 1980*



## Judges vs. Kings

While God used both judges and kings to lead Israel in their respective time periods, several differences distinguish these two groups of leaders.

	<b>Judges</b>	<b>Kings</b>
<b>Period</b>	Theocracy	Monarchy
<b>Dates</b>	1373-1020 BC	1043-586 BC
<b>Length</b>	353 years	457 years
<b>Persons</b>	Othniel to Samuel (13 men, 2 women)	Saul to Zedekiah (39 kings, 1 queen)
<b>Power</b>	Limited (could not tax people or keep a standing army)	Extensive (taxed subjects and kept standing armies)
<b>Jurisdiction</b>	Geographically small (typically over a few tribes of Israel)	Ruled over all the land (united kingdom) or half of it (divided kingdom)
<b>Heredity</b>	Came from various tribes (p. 180a)	Came from various tribes in Israel, but Judah had descendents of David only
<b>Succession</b>	No lineage from father to son, gaps between judges during periods of oppression when no judge ruled	Continuous succession, generally from father to son (Judah, p. 237) though Israel had nine dynasties (p. 236)
<b>Reason Needed</b>	Because Israel refused to live in obedience under the theocracy	Because Israel needed a model of godliness due to rejecting God as king
<b>Basic Responsibility</b>	To deliver Israel from their oppressors	To exemplify God's rule to the Israelites

## OT Book Word Search

Adapted from Heng Siang Hoon (SBC student)

Be a judge yourself! Now that you are half way through this volume, it's time to look back and look ahead at the whole OT. Among the mass of letters below is the name of each of the Old Testament books. Can find all 39 books? They are hidden in every direction.

D U G J H V E S W K M Y V E J K B F D K  
 E L D R L A M E N T A T I O N S Z I T Q  
 C G E N E S I S 2 E J O E L E D 2 S E U  
 C Z U V R H Y O T S O E J O H E Z A Z T  
 L H T G I K T 2 J O B J O E E N E I R H  
 E A E I X T A S W N A H U M M I C A H P  
 S I R H E X I S E G D U J R I M H H P R  
 I M O C Q W R C Z O I W U M A L A A S O  
 A E N A U C H R U F A T A A H 2 R L A V  
 S R O L J O N A H S H A G G A Z I E L E  
 T E M A M 1 C H R O N I C L E S A I M R  
 E J Y M I C A Z S L S G N I K 2 H K S B  
 S W S U D O X E R O J O M N U M B E R S  
 H A G G A I A S A M O S O M 1 C L Z E E  
 K U K K A B A H J O S H U A K S E E M G  
 F O A V Z E P H A N I A H 2 I Z U E N D  
 Q W N H C O G H G G A V A B N A M N O U  
 Z E 1 S A M U E L 2 I N G S G C A E R J  
 Y B N M H 2 M D A N I E L K S H S G H E  
 A C G S I S S E L C I N O R H C 2 I C D

# Ruth

<b>God Rewards the Selfless</b>			
Devotion Brings Food & Protection		Devotion Brings Messianic Ancestry	
Love Revealed		Love Rewarded	
Ruth and Naomi		Ruth and Boaz	
Return		Romance	
Chapters 1–2		Chapters 3–4	
Selflessness Shown	Temporal Rewards	Redemption Requested	Eternal Rewards
Return	Reward	Romance	Redeem
Death of a Family	Ruth Cares for Naomi	Boaz Cares for Ruth	Birth of a Family
Moab	Fields in Bethlehem	Threshing Floor in Bethlehem	Gate in Bethlehem
30 Years			

**Key Word:** Rewards

**Key Verses:** *Devotion:* "... Ruth replied, 'Don't urge me to leave you or to turn back from you. Where you go I will go, and where you stay I will stay. Your people will be my people and your God my God'" (Ruth 1:16).

*Reward:* "'The LORD bless him!' Naomi said to her daughter-in-law. 'The LORD has not stopped showing kindness to the living and the dead. She added, 'That man is our close relative; he is one of our kinsman-redeemers'" (Ruth 2:20)

**Summary Statement:**

Ruth's devotion to Naomi benefits both of them by God's provision of food, a home, and participation in the Davidic and messianic line to demonstrate how God blesses those who help others.

**Application:**

God helps those who help themselves others.

# Ruth

## Introduction

I. **Title** The name Ruth (רֹוּת *ruth*) literally means "friendship" (BDB 946c) and describes the outstanding characteristic of the main person in the book—Ruth herself.

### II. Authorship

A. External Evidence: Talmudic tradition ascribes the authorship of Ruth to Samuel.

B. Internal Evidence: Ruth makes no mention of its author. Some (e.g., *TTTB*, 66) have supposed that authorship by Samuel could not be possible since David appears in Ruth (4:17, 22) and Samuel died before David's coronation (1 Sam. 25:1). However, one must also remember that Samuel himself anointed David as king although he had not yet been crowned (1 Sam. 16). Since the genealogy in the book (4:18-21) stops with David and makes no mention of Solomon, the book was likely written between David's anointing and Solomon's crowning. Since the only tradition ascribes the writing to Samuel, it was written during his lifetime, and no internal evidence proves otherwise, it is most probable that Samuel penned the narrative.

### III. Circumstances

A. Date: As mentioned above, since the genealogy in the book (4:18-21) stops with David and makes no mention of Solomon, the book was likely written after David's anointing (ca. 1030 BC) and, at the latest, just before Solomon's crowning as king (971 BC). However, authorship by Samuel pushes the date back to probably 1030-1020 BC.

Of course, the story itself takes place in the previous era of the judges (1:1). Since this period lasted over 300 years, at what point does the account of Ruth occur? An estimate can be discerned through the genealogy again. Since Ruth was the great-grandmother of David (4:17), who began his rule in 1010 BC, some believe Ruth lived in the latter part of the 12th century at the time of Gideon (e.g., Reed, *BKC*, 1:415-16). However, Gideon ministered in the *early* 12th century (1191-1151 BC) so the latter half of the 12th century places the marriage of Boaz and Ruth at approximately 1120 BC during the judgeship of Jair (Whitcomb, "Chart of the Old Testament Patriarchs and Judges," in these notes, 96). Therefore, Samuel records events which happened approximately one century earlier.

B. Recipients: The first readers of Ruth must have been those under the unified kingdom of Saul and David, some of the older readers having experienced the tragedy of the end of the era of the judges.

C. Occasion: Ruth clearly takes place at the time of the judges (1:1). Samuel records the moral and spiritual failure of Israel during this time in the Book of Judges itself, which ends with two horrible accounts: the hiring of a Levite pagan priest who blesses Dan's ungodly migration (Judges 17—18), and the Benjamites' murder of a concubine with the national retaliation that nearly destroys the tribe (Judges 19—21).

The story of Ruth serves as a third illustration of life at this time, but provides the other side of the story. "The Book of Ruth gleams like a beautiful pearl against a jet-black background" (Reed, *BKC*, 1:415). Perhaps Samuel, as author of Judges, saw the need to balance the picture of the period of the judges with godly examples (Ruth and Boaz) who lived according to the laws of God despite the unfaithfulness of the nation as a whole.

One key theme of Ruth is similar to that of Judges—God's redemption—yet in Ruth this redemption comes not through judicial or executive reforms in a deliverer, but rather through a godly couple who provide the Messianic line through their faithfulness to the covenant and to others. (Ironically, though, the word "covenant" is never used in the book.)

#### IV. Characteristics

- A. Ruth is only one of two books in Scripture named for women (the other being Esther). Esther was a Hebrew who married a Gentile; Ruth was a Gentile who married a Hebrew.
- B. The Book of Ruth contains the second highest proportion of dialogue in the canonical books, surpassed only by the Song of Songs. Of the 84 verses in the narrative, 59 have dialogue!
- C. Irony plays a very important part in the Ruth narrative (adapted from Robert Chisholm, "Theology of Ruth," Dallas Seminary Class Notes, 1985):
1. This, the most beautiful love story in the Bible, never once uses the word "love."
  2. At the beginning of the story God has *blessed* (1:6) but Naomi is *bitter* (1:20-21). However, at the end Naomi is *blessed* (4:14ff.) even though she once wanted to be called Mara, meaning bitter (1:21)!
  3. Naomi initially rules out any possibility that she could provide Ruth with *any* man for a husband (1:11-13), but soon a member of her *own* family marries Ruth (2:20; 4:13)!
  4. In 1:21 Naomi complains that she returns to Bethlehem empty (which insults the ever loyal Ruth standing beside her!), but in the final analysis Ruth is better to her than seven (the ideal number) sons (4:15; cf. 1 Sam. 2:5)!
  5. Boaz prays for Ruth, who has sought refuge under Yahweh's wings (2:12), and within a few months Ruth asks him to cover her with his own wing (3:9). He does so by marrying her and thus answers his own prayer!
- D. The Book of Ruth contrasts with Judges in several ways (*TTTB*, 68, adapted):

<b>Judges</b>	<b>Ruth</b>
<b>Faithlessness</b>	<b>Faithfulness</b>
<b>Immorality</b>	<b>Fidelity, righteousness, purity</b>
<b>Idolatry</b>	<b>Following the true God</b>
<b>Decline, debasement, disloyalty</b>	<b>Devotion</b>
<b>Lust</b>	<b>Love</b>
<b>War</b>	<b>Peace</b>
<b>Cruelty</b>	<b>Kindness</b>
<b>Bethlehem Bad</b>	<b>Bethlehem Benefits</b>
<b>Anarchy</b>	<b>Monarchy</b>
<b>Tribal</b>	<b>National</b>
<b>Saul</b>	<b>David</b>
<b>Disobedience leads to sorrow</b>	<b>Obedient faith leads to blessing</b>
<b>Spiritual darkness</b>	<b>Spiritual light</b>

The book is totally positive. "Ruth is a literary masterpiece. The author, with consummate artistry, great delicacy, obvious enjoyment, yet a bare minimum of words, has depicted people who, although magnanimous, are believable. At one level this is what the story teaches: its characters live, love, and relate so as to be the enfleshment of the Hebrew concept of *s<sup>e</sup>daqa* 'righteousness,' 'integrity,' illustrating in concrete terms life under God's covenant. The story has no villain. Orpah does leave her mother-in-law, but only after a second appeal, and the nearer kinsman is perfectly willing to redeem the land until his own patrimony is jeopardized by the concomitant requirement of marrying Ruth" (LaSor, 614).

E. The Book of Ruth cannot be properly understood without a proper understanding of two important Old Testament customs specified in the Law of Moses:

1. The Practice of Gleaning (Deut. 24:19-22; Lev. 19:9, 10): Israel's "welfare system" required work by the poor ("workfare"). The Law required land owners to leave the corners of the fields and the leftover sheaves so that the poor, the aliens, the widows and the orphans could pick up ("glean") these remaining sheaves. Ruth herself was a beneficiary of this merciful provision in the Law (2:2, 3, 7, 8, 15-19, 22).
2. The Kinsman-Redeemer (Deut. 25:5-10): The Law also required the brother of a deceased man to marry his dead brother's widow and raise up the first son through this marriage in the name of his brother. While the Law prohibited sexual relations with a sister-in-law (Lev. 18:16), this kinsman-redeemer provision was *required* when the brother died: (a) without a son (male heir) and (b) when these brothers lived together having inherited their father's property jointly. The new husband was called the "kinsman-redeemer," or *goel* (Hebrew). If the deceased man had no living brother then the *goel* was the closest male relative. Ruth's first husband, Mahlon (4:10), had no brother, which made the next closest kin responsible (3:12), but since he refused to marry Ruth (4:5-6) Boaz became the closest kin. The emphasis on the *goel* in Ruth is seen in the fact that the kinsman-redeemer appears 13 times in only four chapters.

This kinsman-redeemer (*goel*) theme beautifully typifies the relationship between Christ and the Church. Four requirements were necessary to be a legitimate *goel*, all of which Christ fulfilled as the *goel* to redeem mankind:

1. He must be related by blood to those he redeems (2:20; cf. Deut. 25:5, 7-10). Jesus was God made fully man (John 1:14; Rom. 1:3; Phil. 2:5-8; Heb. 2:14-15).
2. He must be able to pay the redemption price (2:1; cf. 1 Peter 1:18-19).
3. He must be willing to redeem (3:11; cf. Matt. 20:28; John 10:15, 18; Heb. 10:7).
4. He must be free himself (4:10; cf. the virgin birth freed Christ from the curse of sin; Matt. 1:23).

F. Although most (except the first infidel below) would agree that the book contains a beautiful story, the theme of Ruth has been variously interpreted. The following is a partial list of what several have suggested as the main teaching of the book:

1. No Purpose Whatsoever: "...The book of Ruth [is] an idle, bungling story, foolishly told, nobody knows by whom, about a strolling country-girl, creeping shyly to bed with her cousin Boaz. Pretty stuff indeed, to be called the Word of God! It is however, one of the best books of the Bible, for it is free from murder and rapine" (Thomas Paine, *The Age of Reason*)
2. Affirmation of King David's rights to the throne of Israel (John Reed, *BKC*, 1:418). This includes identifying David with the unconditional Abrahamic Covenant in his priestly role in the order of Melchizedek (cf. 1 Chron. 15-17; Pss. 2, 110) rather than the conditional Mosaic Covenant (Thomas L. Constable, "A Theology of Joshua, Ruth, and Judges," in *A Biblical Theology of the OT*, ed. Roy B. Zuck, 96). Thus David functioned both as king (whose genealogy stretched back to Judah—Ruth 4:18; Gen. 49:10) and priest.

3. God's faithful, providential workings: "The Lord is faithful in His business of loving, superintending, and providentially caring for His people" (Reed, *BKC*, 418); cf. "God is at work in the 'corners of the land' though violence may fill the news" (Wiersbe, *Expository Outlines on the Old Testament*, 131); Ruth focuses "on God's providential activity in the lives of the participants" (LaSor, 614); "God watches over His people and brings blessing to those who trust Him" (Morris, 242); Ronald Hals, *The Theology of the Book of Ruth*, Facet Books Biblical Series 23 [Philadelphia: Fortress, 1969], 18).
4. "Since God's people are recipients of His grace they, like Ruth and Boaz, should respond in faithful obedience to Him and in gracious acts towards other people" (Reed, *BKC*, 1:418)
5. Redemption/Kinsman-Redeemer: Illustration of grace by redeeming others (*TTTB*, 67; cf. Reed, *BKC*, 418) and as such is a type of Christ's redemptive role
6. "Put Your Life Together" (title of Warren Wiersbe's book)
7. "Men, watch out for those women; they'll get you yet" (H. Gunkel)
8. Marriage to foreigners is OK—a defense against the exclusivism and nationalism shown in the forced divorcing of pagan wives by Ezra and Nehemiah (Abraham Geiger in 1857, followed by Bertholet, Rost, Weiser). [But Ruth became an Israelite!]
9. Entertainment (R. H. Pfeiffer, *Intro. to OT*, [New York: Harper, 1941], 719)
10. Several other purposes: friendship, faithfulness, kinsman-redeemer, don't exclude Moabites, why David took his parents to Moab (cf. F. B. Huey, "Ruth," *EBC*, 3:512).
11. God blesses those who help others: "As a just king Yahweh [God] (1) **provides** for the needs of widows/resident aliens... and (2) **blesses** (fertility, family continuity, great descendant) those who demonstrate loyalty/devotion (*hesed*) in their relationships to others (cf. Ps. 18:25)" (Robert Chisholm, DTS Notes; Judah J. Slotki, "Ruth" in *The Soncino Books of the Bible: The Five Megilloth*, ed. A. Cohen [London: Soncino, 1946], 38)

Of the many options above, the last description of the purpose of the book seems to have the most to commend it as shown in the following argument and outline.

## Argument

The Book of Ruth chronicles the devotion of Ruth, a young Moabite widow, to Naomi, her widowed mother-in-law. The purpose of this account is to demonstrate how God blesses those who help others, which is especially significant since the story takes place in the most selfish period of Israel's history—the time of the judges—when "every man did what was right in his own eyes" (Judg. 21:25). The LORD blesses Ruth's devotion to Naomi first only through provision of temporal needs such as food and protection (chs. 1–2), but the concluding chapters end climactically with Ruth's reward of a home and especially participation in the Davidic and messianic line (chs. 3–4). Therefore, the Book of Ruth stands as a strong apologetic for the benefits of selfless and righteous living during the most selfish and unrighteous period of Israel's history.

## Synthesis

### God rewards the selfless

1 – 2	<b>Devotion brings food and protection</b>
1	Selflessness shown
1:1-5	Setting
1:6-18	Ruth's Devotion
1:19-22	Naomi's Bitterness

2	Temporal rewards
2:1-3	God's guidance
2:4-16	Food/protection
2:17-23	Hope for redemption
<b>3—4</b>	<b>Devotion brings messianic ancestry</b>
3	Redemption requested
3:1-5	Naomi instructs
3:6-9	Ruth proposes
3:10-15	Boaz accepts
3:16-18	Ladies anticipate
4	Eternal rewards
4:1-13a	Marriage/finances
4:13b	Son
4:14-17	Renewed Naomi
4:18-21	Davidic/Messianic line

## Outline

### Summary Statement for the Book

**Ruth's devotion to Naomi benefits both of them by God's provision of food, a home, and participation in the Davidic and messianic line to demonstrate how God blesses those who help others.**

- I. (Chs. 1—2) **Ruth's devotion to Naomi benefits both of them by God's provision of food and protection to demonstrate how God blesses those who help others.**
  - A. (Ch. 1) Ruth's devotion to her mother-in-law Naomi by leaving family and country to travel to Bethlehem with her exemplifies sacrificial commitment to others and God with no concern for self.
    1. (1:1-5) Ruth becomes the widowed daughter-in-law of the widowed Naomi after the deaths of Ruth's husband Mahlon (Naomi and Elimelech's son) and Naomi's husband Elimelech during the family sojourn in Moab to escape the Bethlehem famine.
    2. (1:6-18) Ruth's devotion to Naomi by leaving family and country to travel to Bethlehem with her exemplifies sacrificial commitment to others and God with no concern for self.
      - a. (1:6-14) When Naomi decides to return home to Bethlehem, her other daughter-in-law, Orpah (Moabite for "stubbornness"), stays in Moab as a statement of her commitment to selfish pursuit in a pagan, idolatrous lifestyle.
      - b. (1:15-18) In contrast to Orpah, Ruth (Heb: "friendship") leaves her family, country, and idolatrous past by devotedly returning to Bethlehem with Naomi as a statement of her commitment to others and God with no concern for self.
    3. (1:19-22) Naomi (Heb: "pleasant") expresses bitterness towards God in her desire to be called Mara (Heb: "bitterness") because of her blindness towards His provision in Ruth as an example of how not to respond to life's difficulties.
  - B. (Ch. 2) Ruth's devotion to Naomi by providing food for her benefits them both by God's provision of food, protection, and hope for future redemption to demonstrate how God blesses those who help others.
    1. (2:1-3) God guides Ruth to the field of her potential kinsman-redeemer, Boaz, in her initiative to provide for Naomi to indicate His pleasure towards those who sacrificially help others.



2. (2:4-16) Boaz rewards Ruth's gleaning for Naomi by protecting and providing food for her as God's blessing for her own sacrificial kindness to Naomi.
3. (2:17-23) When Ruth shares her ample provision of food with Naomi she discovers that Boaz is a potential kinsman-redeemer, thus filling Naomi with anticipation, thankfulness, and hope for future redemption.

**II. (Chs. 3—4) Ruth's devotion to Naomi as seen in her request for redemption by Boaz is rewarded beyond her imaginations with a home and participation in the Davidic and messianic line to show how God blesses those who help others.**

- A. (Ch. 3) Ruth's request for redemption by Boaz demonstrates her devotion to Naomi and his desire to accept her proposal shows his righteous response to his obligation and God's blessing upon Ruth's faith.
  1. (3:1-5) Naomi requests Ruth to follow her plan for the young woman's redemption and Ruth agrees to follow the plan wholeheartedly, thus again demonstrating her devotion to her mother-in-law.
  2. (3:6-9) Ruth's request for redemption by Boaz demonstrates her devotion to Naomi since without Ruth's marrying she has no long-term means of supporting herself and Naomi.
  3. (3:10-15) Boaz gladly pledges to receive Ruth's proposal contingent upon the refusal of the nearer kinsman, indicating his righteous response to his obligation and God's blessing upon Ruth's faith.
  4. (3:16-18) Naomi and Ruth anticipate Ruth's redemption by either the nearer kinsman or Boaz that very day.
- B. (Ch. 4) Ruth's reward of redemption by Boaz for her devotion to Naomi exceeds her wildest imaginations through a godly husband, son, renewed Naomi, and participation in the Davidic and messianic line as demonstration of how God blesses those who help others.
  1. (4:1-13a) Marriage and financial security become Ruth's reward for her devotion to Naomi as the nearer kinsman refuses his right to redemption and Boaz marries Ruth.
  2. (4:13b) The birth of Ruth's son Obed becomes her reward for her devotion to Naomi.
  3. (4:14-17) A renewed Naomi becomes Ruth's reward for her devotion to Naomi!
  4. (4:18-22) Participation in the Davidic and messianic line becomes Ruth's greatest reward for her devotion to Naomi as demonstration of how God blesses those who help others, although this happens in her old age and perhaps even after her death.

# The Book of Ruth

Set in the dark and bloody days of the judges, the story of Ruth is silent about the underlying hostility and suspicion the two peoples—Judahites and Moabites—felt for each other. The original onslaught of the invading Israelite tribes against towns that were once Moabite had never been forgotten or forgiven, while the Hebrew prophets denounced Moab's pride and arrogance for trying to bewitch, seduce and oppress Israel from the time of Balaam on. The Mesha stele (c. 830 B.C.) boasts of the massacre of entire Israelite towns.

Moab encompassed the expansive, grain-filled plateau between the Dead Sea and the eastern desert on both sides of the enormous rift of the Arnon River gorge. Much of eastern Moab was steppeland—semi-arid wastes not profitable for cultivation, but excellent for grazing flocks of sheep and goats. The tribute Moab paid to Israel in the days of Ahab was 100,000 lambs and the wool of 100,000 rams.

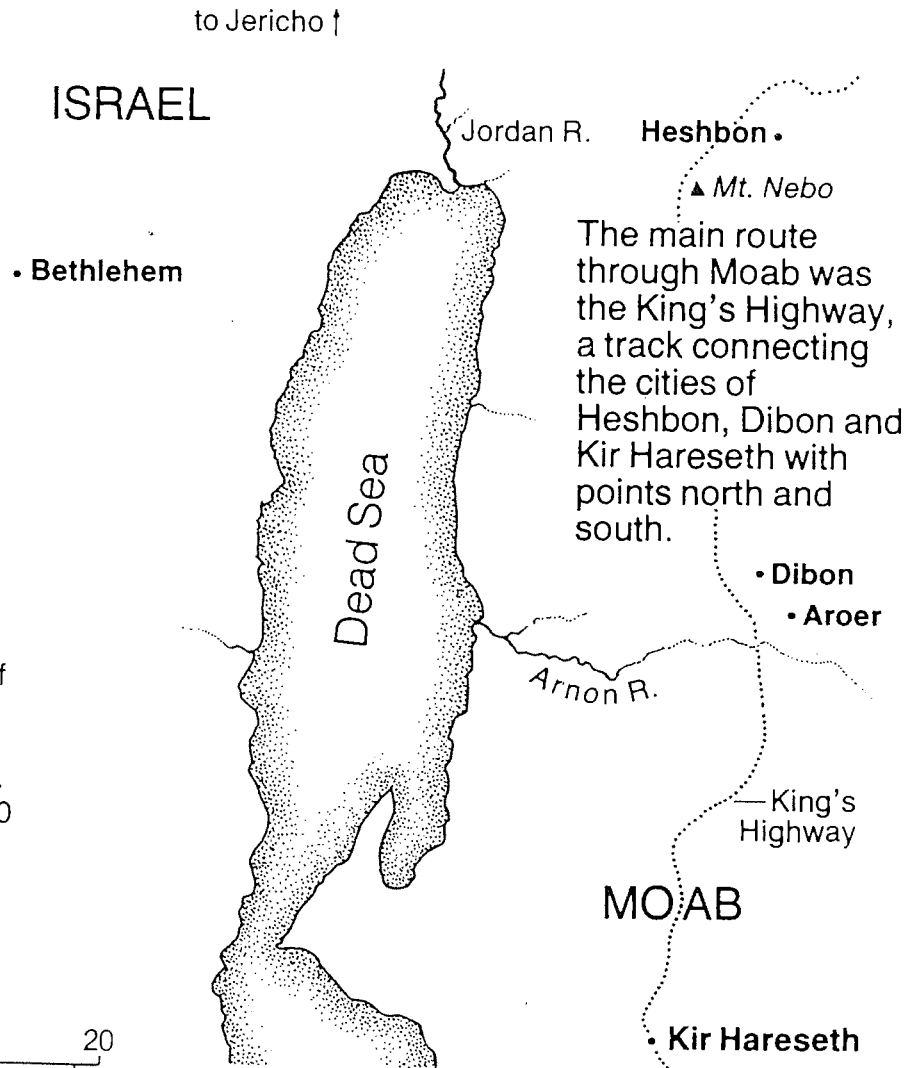
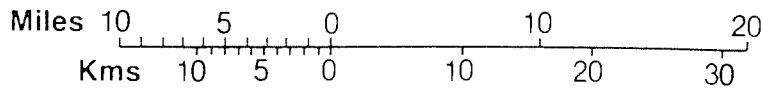

The main route through Moab was the King's Highway, a track connecting the cities of Heshbon, Dibon and Kir Hareseth with points north and south.

**Geography of Ruth**  
*The Bible Visual Resource Book, 53*

## Theology of Ruth

Adapted from Thomas L. Constable, "A Theology of Joshua, Ruth, and Judges," in *A Biblical Theology of the OT*, ed. Roy B. Zuck, 95-96, 117

*The book of Ruth serves as a hinge between Judges and Samuel, theologically speaking. This is especially true in the contrast between how Bethlehem and Gibeah are presented:*

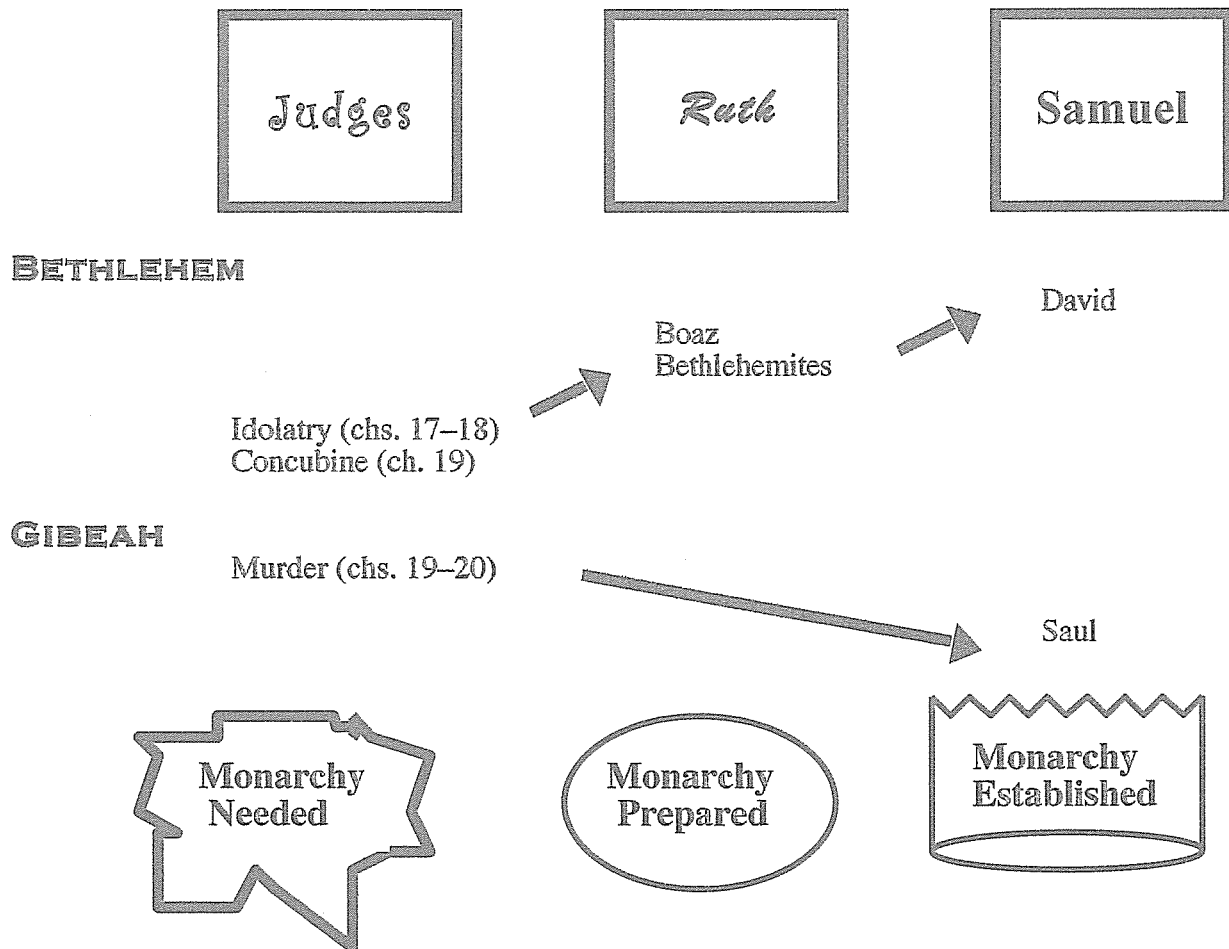

The rise of David and the demise of Saul appear as parallel themes from the books of Judges to Samuel. This is evident in the depictions of their cities of origin.

Bethlehem, the city of David, begins poorly in two incidents of false worship and sensuality. A Levite from Bethlehem begins employment as a pagan priest (Jud. 17-18) and a concubine from Bethlehem becomes abused by the men of Gibeah (Jud. 19). However, the town becomes virtuous in Ruth, where both Boaz and the people show themselves true worshippers of God. The climax in 1 Samuel 16 shows David, the ideal king, pure both in sensual desires and in worship of the Lord.

Gibeah, the hometown of Saul (1 Sam. 10:26), provides a stark contrast. This Benjamite city also begins poorly by murdering the Bethlemite concubine (Jud. 19). This incurs the wrath of the other tribes on all Benjamites, nearly destroying the tribe altogether (Jud. 20). Things even get worse. In Samuel, this degenerates to Saul's mad attempt to murder the very chosen king himself (from Bethlehem).

Therefore, Ruth is the pivot book between the others, indicating the rise of Bethlehem (David) while the lack of mention of Gibeah at all downplays the role the Benjamites and Saul have in God's plan.

# 1 Samuel

<b>Degenerate Theocracy to Davidic Monarchy</b>				
Theocracy Ended (Decline of Judges)		Monarchy Established (Rise of Kings)		
Chapters 1–7		Chapters 8–31		
Samuel: “Heavenly King”		Saul: “Earthly King”		
Eli	Samuel	Saul		David
Man After Man’s Heart	Man After God’s Heart	Man After Man’s Heart		Man After God’s Heart
Paralysis	Prayer	Panic		Patience
<i>Transition #1</i> Eli to Samuel (1–3)	Samuel & Ark’s Wanderings (4–7)	<i>Transition #2</i> Samuel to Saul (8–12)	Saul Rejected (13–15)	<i>Transition #3</i> Saul to David (16–31)
c. 94 Years				
Birth of Samuel (1105 BC) to Death of Saul (1011 BC)				

**Key Word:** Transition

**Key Verse:** “[The people] said to [Samuel], ‘You are old and your sons do not walk in your ways; now appoint a king to lead us, such as all the other nations have’ (1 Samuel 8:5)

**Summary Statement:**

The transition from a degenerate theocracy under Eli and Samuel to a monarchy under Saul and David is recorded to show how God's sovereignty is delegated to the divinely elected Davidic kings.

**Applications:**

Ability to handle transitions comes from honoring God.

God raises up or lowers us based upon whether we honor or dishonor him: “Those who honor me I will honor, but those who despise me will be disdained” (2:30).

- 1) God blesses obedience: “to obey is better than sacrifice” (15:22).
- 2) God disdains mere show: “the LORD does not see as man sees” (16:7).

# 1 Samuel

## Introduction

**I. Title** The name "Samuel" (שְׁמוּאֵל *semuel*) means "name of El [God]" or "his name is El [God]" (BDB 1028d 1) from the compound of שָׁמַי, "name," and אֵל, "El," the singular form of אֱלֹהִים, "Elohim." It also sounds similar to the Hebrew for "heard of God" (from שָׁמַע; cf. 1 Sam. 1:20). The Books of Samuel in the earliest Hebrew manuscripts formed a single scroll simply entitled "Samuel" after the first important character in the account. The Septuagint was the first translation to divide the book into two with the titles First Kingdoms and Second Kingdoms. First and Second Kings then followed with the titles Third Kingdoms and Fourth Kingdoms.

## II. Authorship

- A. **External Evidence:** The Jewish talmudic tradition ascribed the authorship of First and Second Samuel to Samuel, but he could not have written beyond 1 Samuel 25:1 since this verse records his death. First Chronicles 29:29 refers to "the Book of Samuel the Seer," "the Book of Nathan the Prophet," and "the Book of Gad the Seer." This may be a reference to the threefold authorship of the Books of Samuel which may have been compiled in their final form by a member of the prophetic school. Since First and Second Samuel originally formed a single scroll entitled "Samuel," this may account for his name being attached to both books.
- B. **Internal Evidence:** The author refers to Samuel's written record of the regulations of the kingship (1 Sam. 10:25), so writing a book was not out of the ordinary for Samuel. As head of a company of prophets (1 Sam. 10:5; 19:20) he is the most likely candidate for authorship of the first book up to chapter 25.

## III. Circumstances

- A. **Date:** Although 1 Samuel 1—24 was recorded by Samuel at the end of his life (born ca. 1105 BC, died ca. 1015 BC), the remainder of the Books of Samuel must have been composed over 85 years later following the division of the kingdom between Israel and Judah in 931 BC. This is indicated by references to the divided monarchy (1 Sam. 11:8; 17:52; 19:16; 2 Sam. 5:5; 11:11; 12:8; 19:42-43; 24:1, 9) and the reference to Ziklag, a Philistine city which the writer says, "has belonged to the kings of Judah to this day" (1 Sam. 27:6). In regard to the *latest* possible date of composition, the absence of reference to the fall of Samaria in 722 BC is notable. Therefore, the time of final composition most likely falls between 931 BC and 722 BC.
- B. **Recipients:** Since the first author of the Books of Samuel (Samuel himself) chronicles the beginning of Saul's reign, the readers of 1 Samuel 1—24 all must have been Jews living during the time of the monarchy. However, those who read the books in their final form had already experienced the division of the empire.
- C. **Occasion:** Since Judges 17—21 and Ruth serve as supplementary material to the account of the judges period, the Books of Samuel actually continue the story line left off at Judges 16:31. First Samuel concludes the period of the judges with the final two judges not mentioned in Judges (Eli and Samuel) and introduces the monarchy of Israel with the reign of Saul, Israel's first king. Even though Israel's desire for a king to be "like all the other nations" (1 Sam. 8:5, 20) was a carnal plan in that it rejected the LORD as king, the concept of human royalty was part of God's plan even as early as the time of the patriarchs (Gen. 17:6, 16; 35:11; cf. Deut. 17:14-20). As to what motivated the authors to record this transitional history from theocracy to monarchy, perhaps it was the desire to defend the Davidic dynasty (cf. 2 Sam. 7).

## IV. Characteristics

- A. First Samuel is the first book in Scripture to use the word *Messiah* ("anointed," 2:10) and the first to refer to God as "the LORD of hosts" (e.g., 1:3).

- B. Two of the three major characters in 1 Samuel are types of Christ: Samuel as prophet and priest, and David as the shepherd-king born in Bethlehem.
- C. The Book of 1 Samuel introduces the first of the prophets of Israel in the person of Samuel (Acts 3:24), who also served as the last judge. The key word for this book is *transition*.

## Argument

The Book of 1 Samuel, in its most general sense, traces the transition from Israel's theocracy in which Samuel serves as the last judge (chs. 1—7) to the nation's beginnings as a monarchy under the kingship of Saul (chs. 8—31). Within this overall design are three transitions of leadership: from Eli to Samuel (chs. 1—3), from Samuel to Saul (chs. 8—12), and from Saul to David (chs. 16—31). The intervening sections maintain that while Samuel filled a much needed place of leadership among the people (chs. 4—7), the best replacement for him was not Saul, the people's choice as king whom God rejected (chs. 13—15), but rather David, a man after God's own heart.

Therefore, the theological design of 1 Samuel is not to simply trace the history of Israel's change of government, but more specifically, to demonstrate God's approval of the Davidic line as the divinely sanctioned dynasty of the delegated sovereignty of God.

## Synthesis

### Degenerate theocracy to Davidic monarchy

<b>1—7</b>	<b>Theocracy ended</b>	
1—3	#1: Eli to Samuel	# = Leadership transitions
1	Samuel's birth	
2:1-11	Hanna's prayer	
2:12-36	Eli's house rejected	
3	Samuel's call	
4—7	Ark = Samuel needed	
4	Captured	
5	With Philistines	
6	Returned	
7	Restored	
<b>8—31</b>	<b>Monarchy established</b>	
8—12	#2: Samuel to Saul	
8	King demanded	
9:1—10:16	Private anointing	
10:17-27	Public coronation	
11	Jabesh Gilead/reaffirmation	
12	Samuel retires as judge	
13—15	Saul rejected	
13:1-22	Presumptuous sacrifice	
13:23—14:52	Food prohibition	
15	Amalekites spared	
16—31	#3: Saul to David	
16—17	Friends	
18—27	Enemies	
18—20	David's flight	
21—27	David's exile	
28—31	Saul abandoned, David blessed	
28	Saul at Endor	
29	David refused battle	
30	David destroys Amalekites	
31	Saul's death	

## Outline

### Summary Statement for the Book

**The transition from a degenerate theocracy under Eli and Samuel to a monarchy under Saul and David is recorded to show how God's sovereignty is delegated to the divinely elected Davidic kings who were to rule justly.**

#### **I. (Chs. 1—7) The decline of the theocracy through an ignorance of God's character necessitates the transfer of leadership from Eli to Samuel to prepare the nation to be governed by a monarchy.**

- A. (Chs. 1—3) The first transition of national leadership from Eli to Samuel is seen in Samuel's birth, call, and acceptance by Israel to replace Eli's wicked house in preparation for the prophesied monarchy.
1. (Ch. 1) Samuel's unique birth and childhood demonstrate from God's perspective Israel's need for a new leader due to the pathetic state of the era of the judges.
  2. (2:1-11) Hanna's prophetic prayer acknowledges God's attributes and His future provision of a monarchy.
  3. (2:12-36) The wicked state of the priesthood in Eli's house (by his sons' immorality with the tabernacle women like the priests of Baal) contrasts with Samuel's holy lifestyle to show the need for a new leader for Israel.
  4. (Ch. 3) Samuel's call by the LORD and acceptance by the people is recorded to verify the transition of leadership from Eli to Samuel.
- B. (Chs. 4—7) The need for Samuel's leadership is seen in the ignorance of the character of God evident in the capture of the ark by the Philistines.
1. (Ch. 4) The capture of the ark by the victorious Philistines and the resultant deaths of Eli and his sons fulfill the LORD's prophecy against Eli and show the need for a righteous replacement due to Israel's limited understanding of God's omnipresence.
  2. (Ch. 5) The power of the ark in the Philistine camp demonstrates God's omnipotence over all gods and grace towards Israel even in the nation's disobedience.
  3. (Ch. 6) The return of the ark to Beth-Shemesh is accompanied by sacrifices and the deaths of 50,070 Israelites who high-handedly sin by looking into the ark, thus showing the sovereignty and holiness of God.
  4. (Ch. 7) The ark's restoration to Kiriath Jearim and the resultant victories of Israel over the Philistines show God's presence with the nation and its need for Samuel, a new leader.

#### **II. (Chs. 8—31) The beginning of the monarchy traces the transfer of leadership from Samuel to Saul to David despite the evil motives for the monarchy to show how God's sovereignty is delegated to the divinely elected Davidic kings.**

- A. (Chs. 8—12) The second transition of national leadership from Samuel to Saul marks the beginning of the monarchy due to Israel's evil motives.
1. (Ch. 8) Israel's demand for a king due to national rejection of the LORD as King shows the nation's evil motives for the monarchy despite future oppression by its kings.
  2. (Chs. 9—12) The transition from Samuel as judge to Saul as king marks the beginning of the monarchy in opposition to God's desire.
    - a. (9:1—10:16) Samuel privately anoints Saul as king to prepare him for public coronation.

- b. (10:17-27) Samuel publicly makes Saul king as an official declaration of God's displeasure with the nation's decision.
  - c. (Ch. 11) Saul's rescue of the city of Jabesh Gilead and the reaffirmation of Saul at Gilgal confirm him as king in the eyes of the people.
  - d. (Ch. 12) In his retirement speech from public office as judge (but not prophet) Samuel reminds Israel of the sin of asking for a king to convince the people of the need to live according to the Mosaic covenant.
- B. (Chs. 13–15) The LORD rejects Saul as king for his many failures to obey God to show Israel's need for a righteous king.
1. (13:1-22) Saul's impatience causes him to allow the priests to offer sacrifices without waiting seven days for Samuel in fear of a Philistine invasion, and Samuel hints at his rejection by stating that the LORD has already appointed a godly king.
  2. (13:23–14:52) Saul's rashness in keeping his men from food prevents a complete victory over Philistia, encourages his men to eat blood unlawfully, and shames him in his vow to kill the "disobedient" Jonathan—showing his inability to rule righteously.
  3. (Ch. 15) Saul's disobedience by not completely destroying the Amalekites is his last act of disobedience before the LORD rejects him as king to show Israel's need for a righteous king.
- C. (Chs. 16–31) The third transition of national leadership from Saul to David records the deterioration of their relationship as evidence of God's rejection of Saul and anointing upon David—showing God's blessing upon the Davidic dynasty rather than Saul's line.
1. (Chs. 16–17) Saul and David relate as friends while David rises as his personal musician and warrior.
    - a. (Ch. 16) After David is privately anointed king he receives valuable instruction in royal matters as Saul's personal court musician and friend.
    - b. (Ch. 17) David's victory over Goliath wins Saul's approval as one of his warriors.
  2. (Chs. 18–27) Saul and David relate as enemies where Saul's jealous attempts to kill him forces him into exile where he submits to God's valuable lessons which will enable him to reign righteously.
    - a. (Chs. 18–20) David's flight from Saul evades his jealous, murderous efforts which reveals God's choice of David as founder of the messianic dynasty of kings.
      - 1) (18:1-9) Saul burns with envy over David's greater popularity in Israel which reveals God's choice of David as founder of the messianic dynasty of kings.
      - 2) (18:10–20:42) Saul attempts to kill David in several ways out of jealousy over God's blessing on his life as a carnal response to the revealed will of God.
        - a) (18:10-16) Saul tries to kill David by throwing a spear at him.
        - b) (18:17-30) Saul tries to kill David by tricking him to fight the Philistines.
        - c) (19:1-7) Saul tries to kill David by commanding his servants to kill David.
        - d) (19:8-10) Saul tries to kill David by throwing a spear at him again.
        - e) (19:11-17) Saul tries to kill David by sending messengers to kill him.



- f) (19:18-24) Saul tries to kill David by seeking his life at Samuel's house.
  - g) (Ch. 20) Saul tries to kill David by commanding Jonathan to betray him.
- b. (Chs. 21–27) David's exile prepares him to be king by teaching him many valuable lessons that would enable him to reign righteously.
- 1) (21:1-9) At Nob, David eats the consecrated bread and thus learns the concession that the Law permitted—that life is more holy than bread (cf. Matt. 12:7-8).
  - 2) (21:10-15) At Gath, David forces himself to feign insanity before Achish and learns not to go to his enemies for protection.
  - 3) (22:1-2) At the cave of Adullam, David gathers four hundred "down-and-outers" and learns a ministry of compassion which later enables him to reign compassionately.
  - 4) (22:3-4) At Mizpah, David leaves his parents at Moab—kin of his great-grandmother Ruth—and learns the necessity of taking care of his family.
  - 5) (22:5-23) At the forest of Hereth, David learns of Saul's senseless slaughter of eighty-five priests and the entire town of Nob because of Abimelech's assistance to David which teaches him of the perils of jealousy.
  - 6) (23:1-12) At Keilah, David delivers the town from invasion by both the Philistines and Saul, which instructs him in the necessity of consulting the LORD for decision making.
  - 7) (23:13-23) At Horesh in the desert of Ziph, David is encouraged by Jonathan but betrayed by Ziphites who reveal his location to Saul, which teaches David the importance of finding strength in God when betrayed.
  - 8) (23:24-28) In the desert of Maon, David barely escapes Saul, who breaks his pursuit to rout Philistines invading the land, which teaches David that his life is in God's hands.
  - 9) (23:29–24:22) In a cave at En Gedi, David spares Saul's life in respect for the authority Saul carries as God's chosen king, which instructs David to use his future kingly authority for righteous, not evil, purposes.
  - 10) (Ch. 25) In the desert of Maon, David learns not to act rashly by taking matters into his own hands like Saul through the entreaty of Nabal's wife Abigail, who sees David as God's anointed and whom he marries after the LORD kills Nabal.
  - 11) (Ch. 26) On the hill of Hakilah, David again spares Saul's life in respect for the authority Saul carries as God's chosen king, which again instructs David to use his future kingly authority for righteous, not evil, purposes.
  - 12) (Ch. 27) At Gath and Ziklag, David develops his leadership and combat skills by carrying out raids against peoples south of the Philistines.

Application: When an oppressive superior mistreats you (like Saul mistreated David), how do you respond? If you do not learn submission and brokenness, eventually when *you* get into a position of authority, *you too could become a "Saul"* who grasps for power! Learn the lesson of David. As we will see in 2 Samuel, David eventually had plenty of opportunities to imitate Saul—especially when his son Absalom claimed to be the rightful "third king" after Saul and David. This decision of David *not* to become a Saul is well said in this modern classic for those in ministry transition: Gene Edwards, *A Tale of Three Kings: A Study in Brokenness* (Wheaton, IL: Tyndale, 1980, 1982). It's a fast-moving, stirring, and biblical account of only 98 pages.

3. (Chs. 28–31) The final days of Saul's life are characterized by abandonment from God to Satan in contrast to David's experience of the LORD's providential care to show God's blessing upon the Davidic dynasty rather than Saul's line.
  - a. (Ch. 28) By God's intervention through the necromancer of Endor, the dead (resurrected) Samuel tells Saul of his death the next day as the end of Saul's rebellion towards God.
  - b. (Ch. 29) David is providentially spared from fighting his own people while en route to battle Israel, and is commanded by Achish to return to Ziklag.
  - c. (Ch. 30) David completely destroys Amalekite raiders who had destroyed Ziklag and carried off the plunder as an indication of God's providential dealings in his life.
  - d. (Ch. 31) The Philistines kill Saul as God's punishment for his rebellion and God's vindication of David's righteousness by not killing Saul himself, thus showing divine blessing on the Davidic dynasty rather than Saul's line.

### Judges' vs. Kings' Leadership

Adapted from Homer Heater, "A Theology of Samuel and Kings," in *A Biblical Theology of the OT*, ed. Roy B. Zuck, 139

	Judges	Kings
<i>Rule</i>	Local	Nation-wide
<i>Appointment</i>	Spontaneous	Planned
<i>Succession</i>	Not passed on to children	Dynasties
<i>Effect on Tribes</i>	Independent	Unified

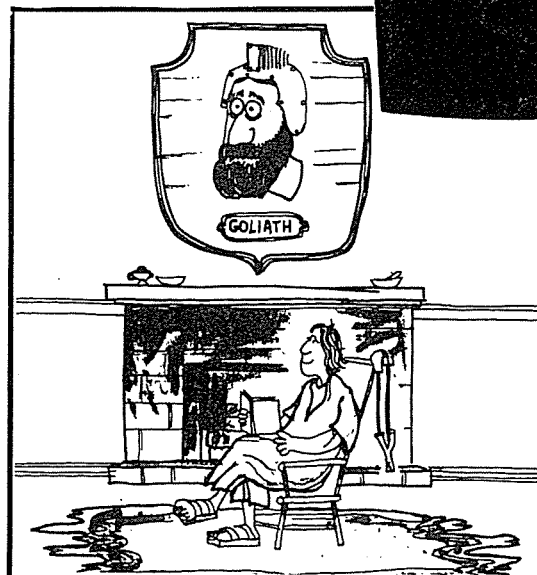

## Biographical Contrast by Interchange (1 Sam. 1–12)

Donald K. Campbell, Dallas Theological Seminary (adapted class handout)

*The beginning narrative of 1 Samuel contrasts the family of Eli with Samuel by repeatedly reverting back and forth between the two. This is designed to show that Eli was unworthy of the priesthood whereas Samuel was qualified spiritually to be the priest who would bring Israel into a new era. This transition in the priesthood hints at a national transition from a theocracy to a monarchy as well.*

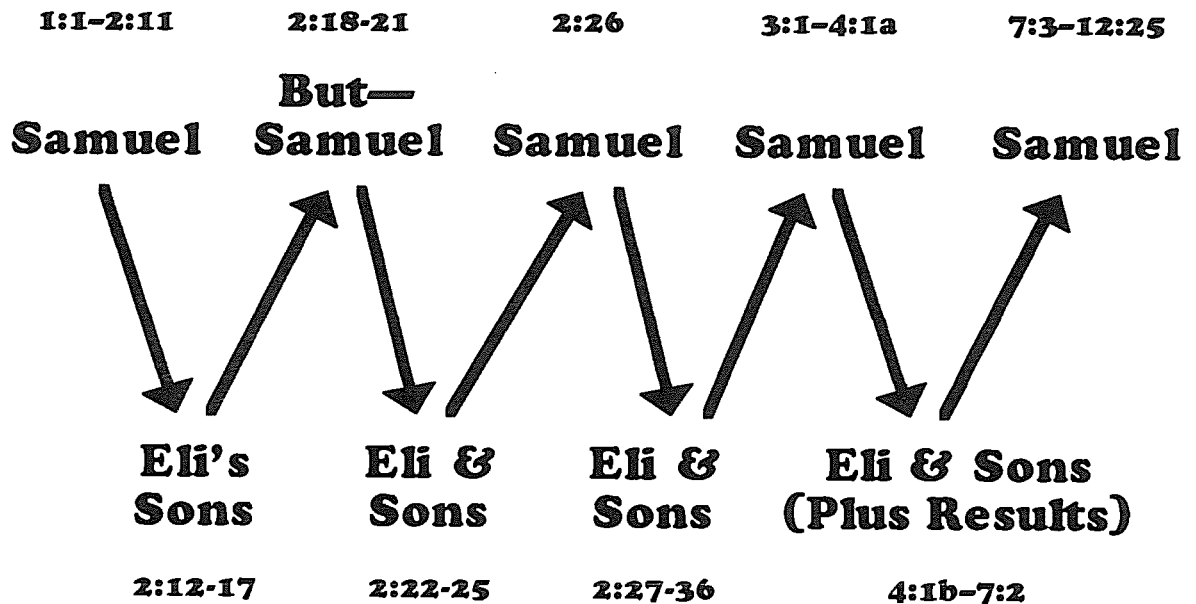

# The Line of Aaron

Donald K. Campbell, Dallas Theological Seminary

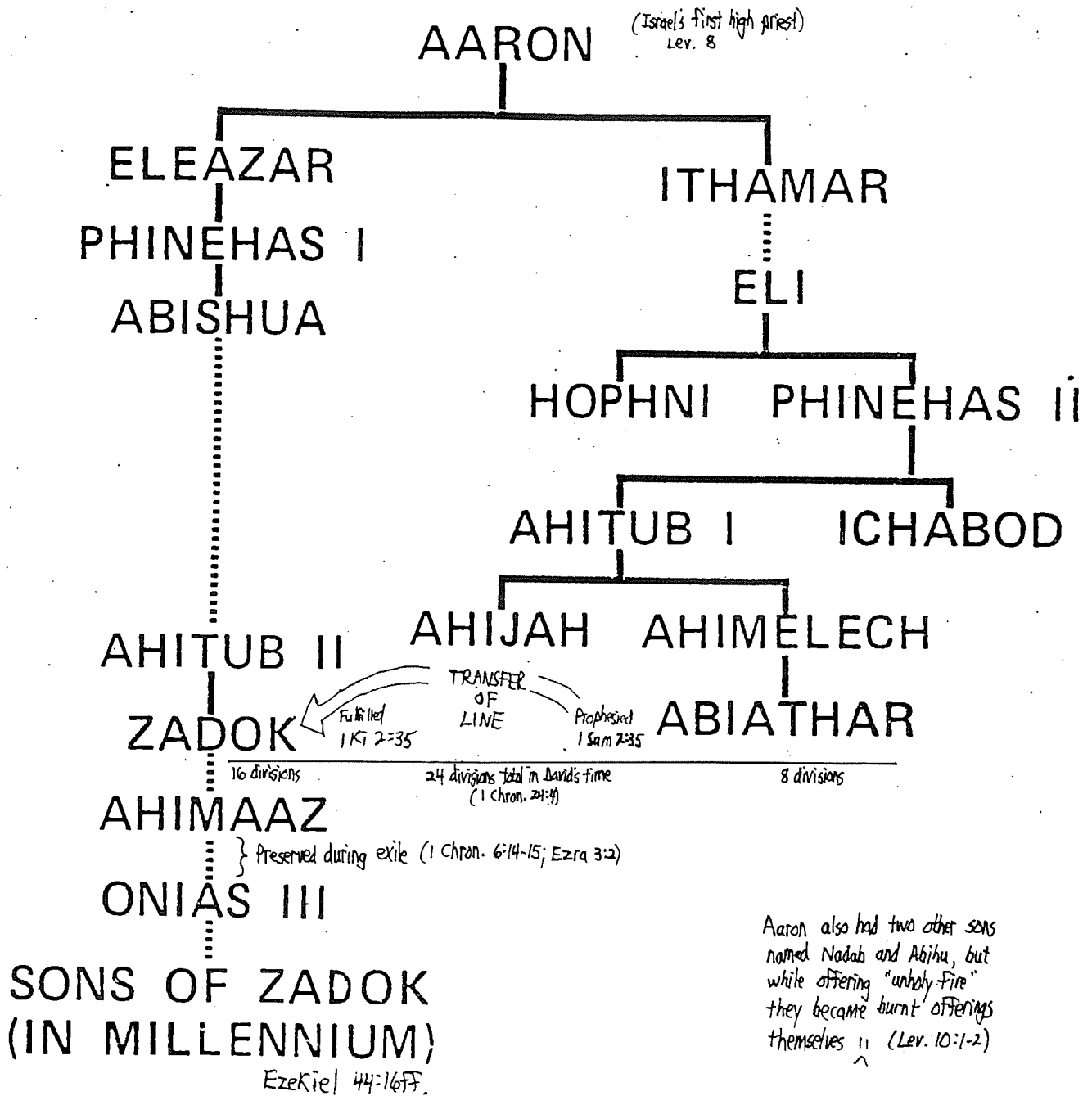

# The Life and Ministry of Samuel

*Nelson's Complete Book of Bible Maps and Charts*

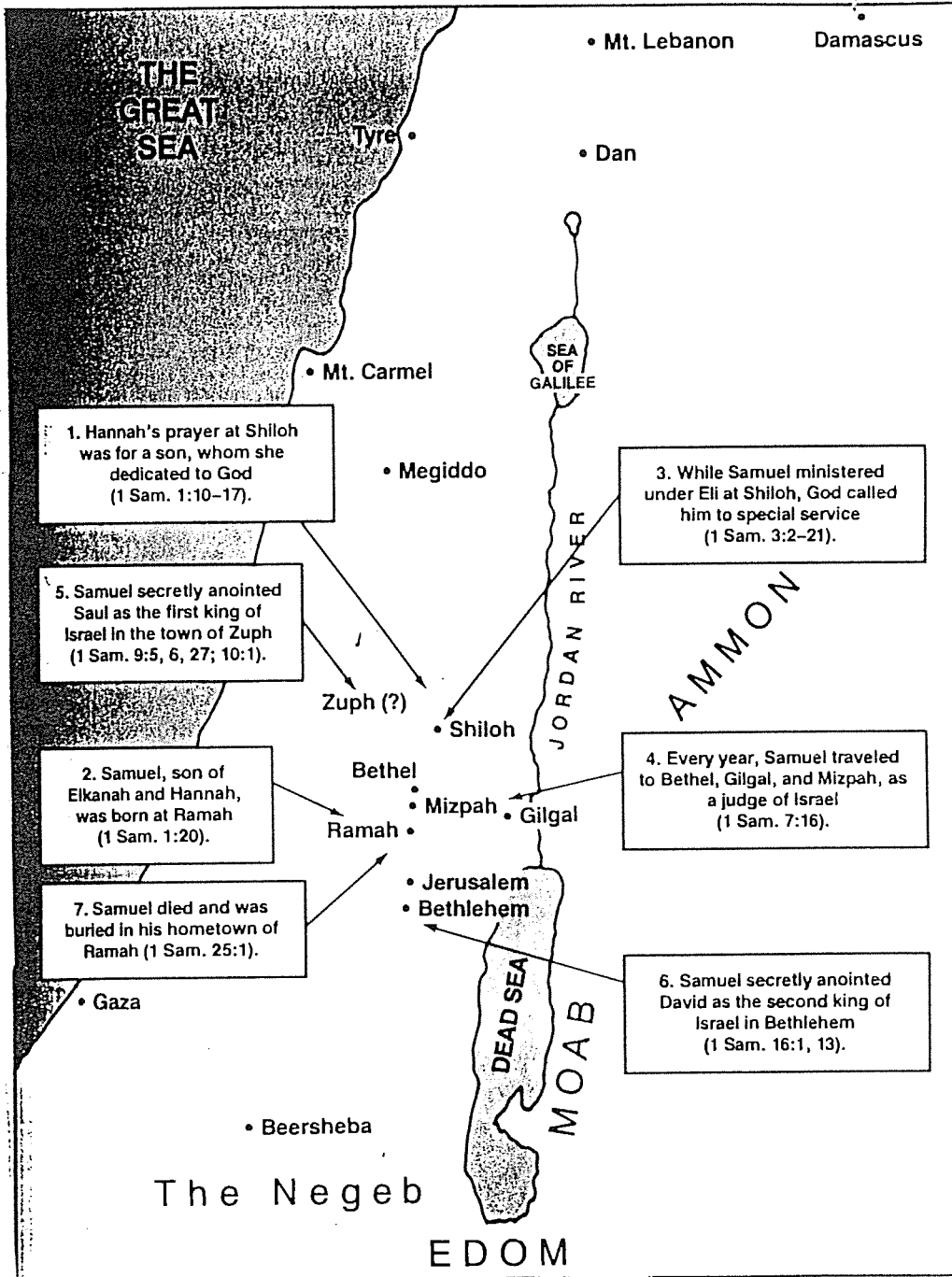

## Saul's Military Campaigns

*Nelson's Complete Book of Bible Maps and Charts*

As the first king of the united kingdom of Israel, Saul's major task was to subdue the nation's enemies. At first, he won several decisive battles. But his campaigns bogged down when he turned his attention to David, attempting to wipe out what he perceived as a threat to his power. Saul and his sons were eventually killed by the Philistines.

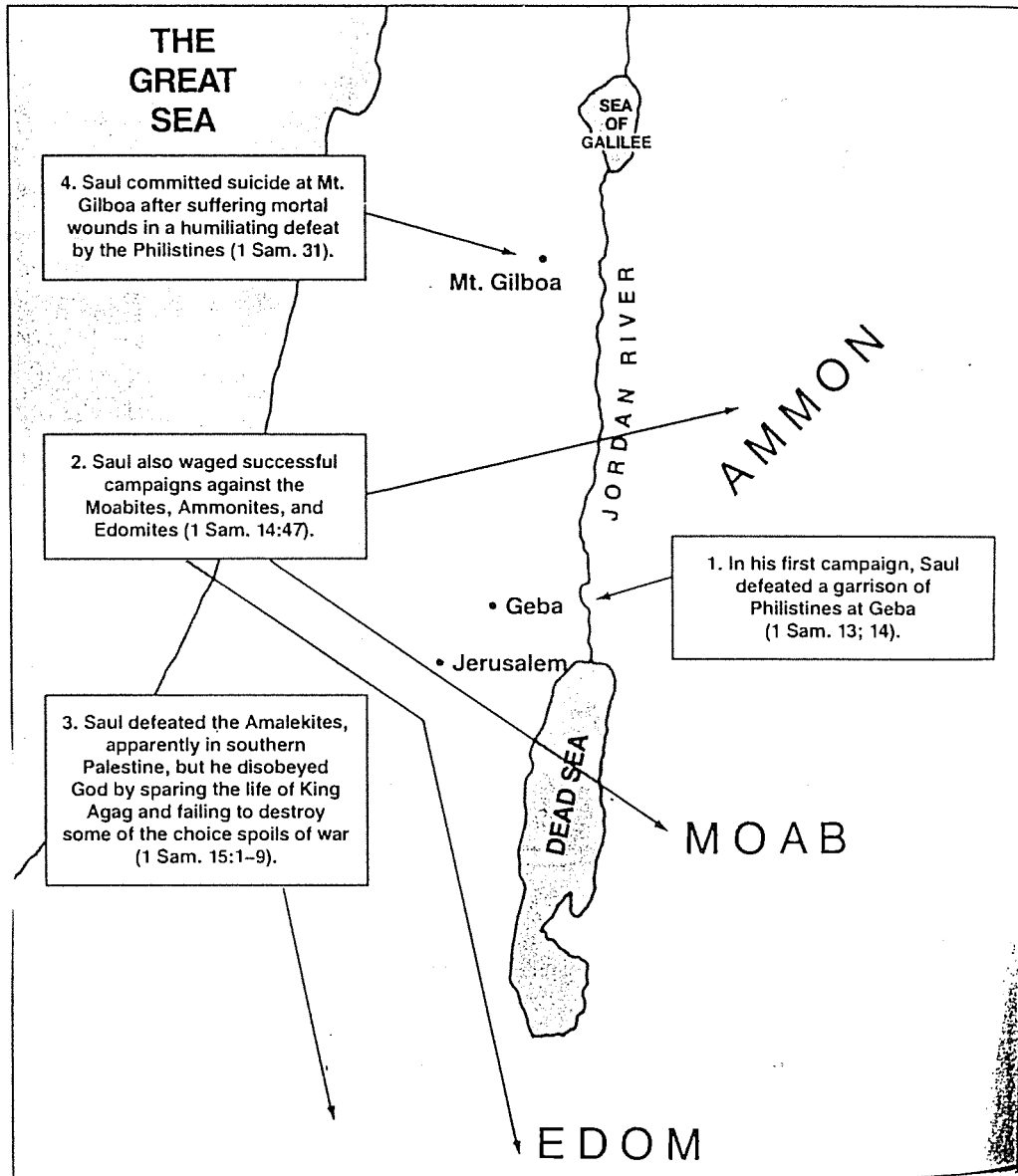

1 Samuel 4-5

# THE WANDERINGS OF THE ARK OF THE COVENANT

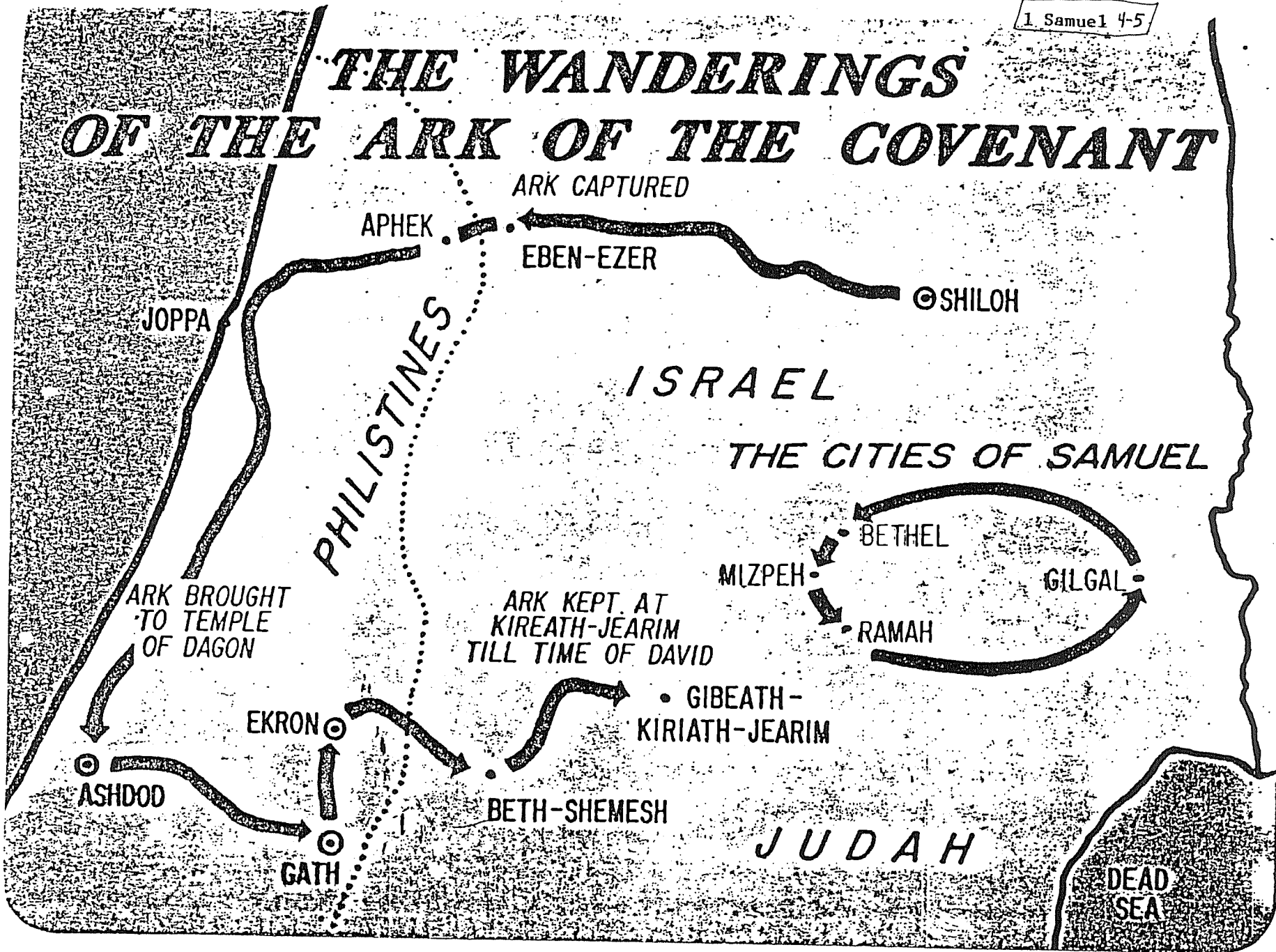

The Wanderings of the Ark of the Covenant  
Donald K. Campbell, Dallas Theological Seminary

# THE BATTLE OF MICHMASH

PUNITIVE RAIDS  
( I SAM. 13:17--18)

— PHILISTINE MOVEMENT  
--- ISRAELITE MOVEMENT

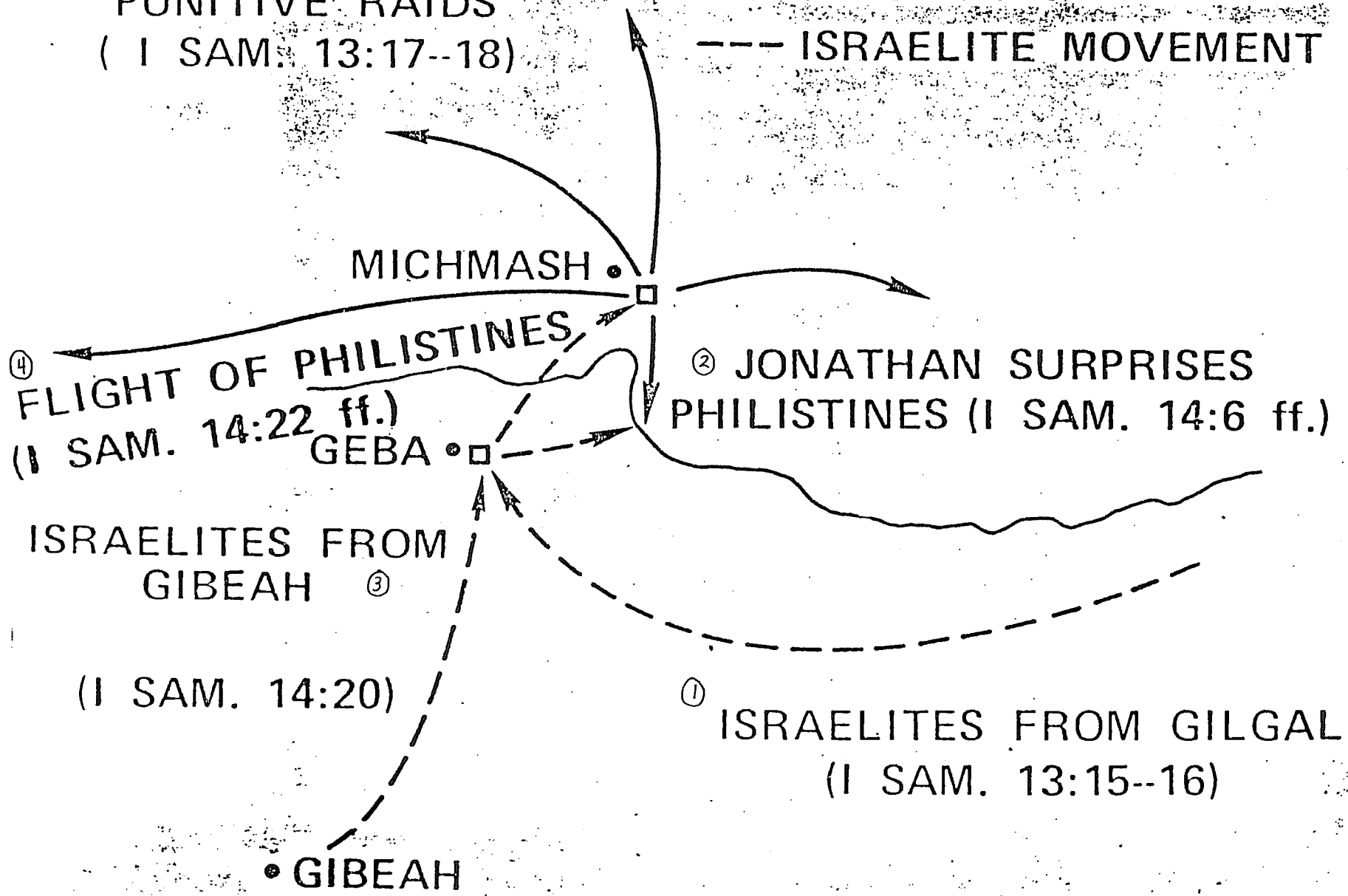



### Saul's Family Tree

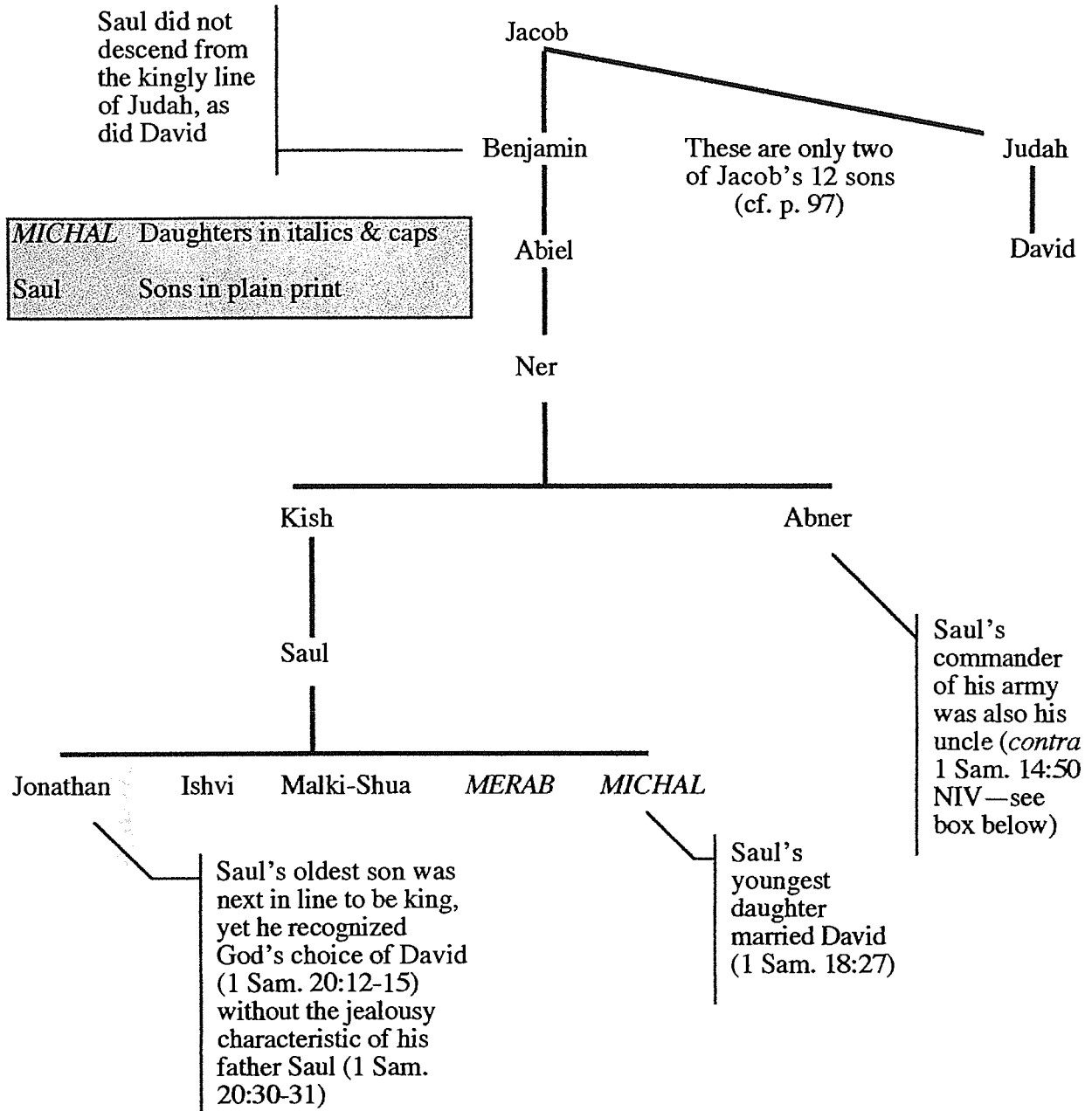

***Was Abner Saul's uncle or his cousin?***

"According to 1 Chronicles 8:33 and 9:39 Ner was Saul's grandfather (Ner's son was Kish and Kish's son was Saul), but in 1 Samuel 14:50 Ner appears to be Saul's uncle and Abner his cousin. In 1 Chronicles Abner, though not mentioned, would be Saul's *uncle*, for Abner was Ner's son (1 Sam. 14:50). This seeming contradiction is eliminated by the Hebrew of 1 Samuel 14:50b, which says literally, 'Abner son of Ner, uncle of Saul,' with the understanding that the ambiguous 'uncle of Saul' refers not to Ner but to Abner" (Eugene Merrill, "1 Samuel," *BKC*, 1:446-47, *italics* his). Thus the chart above is probably correct even though it disagrees with the NIV in 1 Samuel 14:50b.

# David's Family Tree

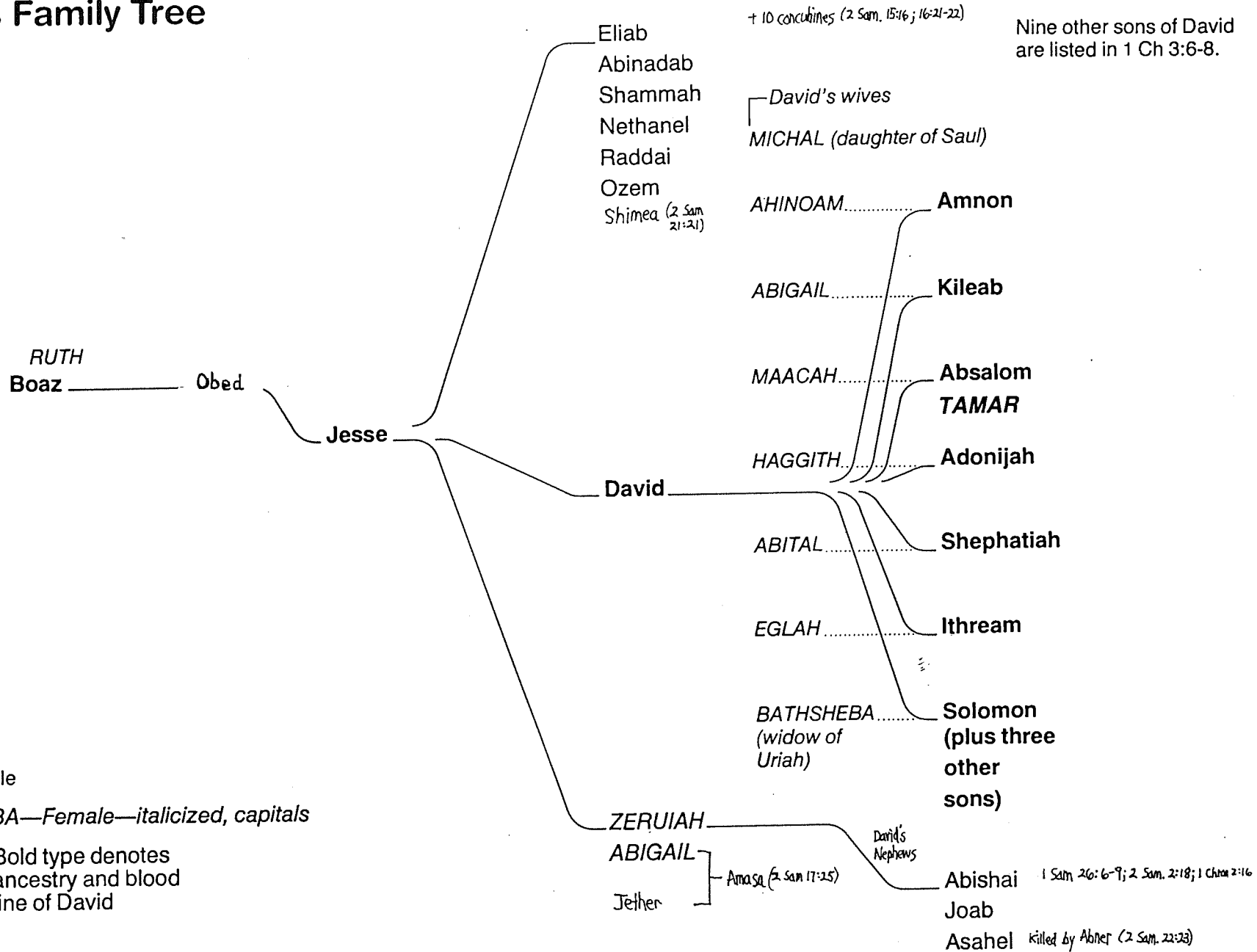

Dr. Rick Griffith

Old Testament Survey: 1 Samuel

David's Family Tree  
The Bible Visual Resource Book, 57

# David as Fugitive and Warrior

*The Bible Visual Resource Book, 59, adapted*

## David the Fugitive

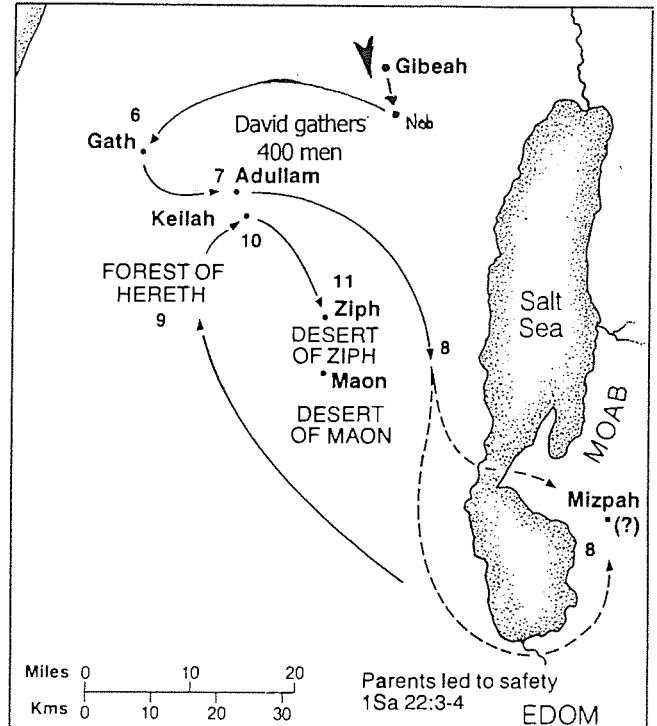
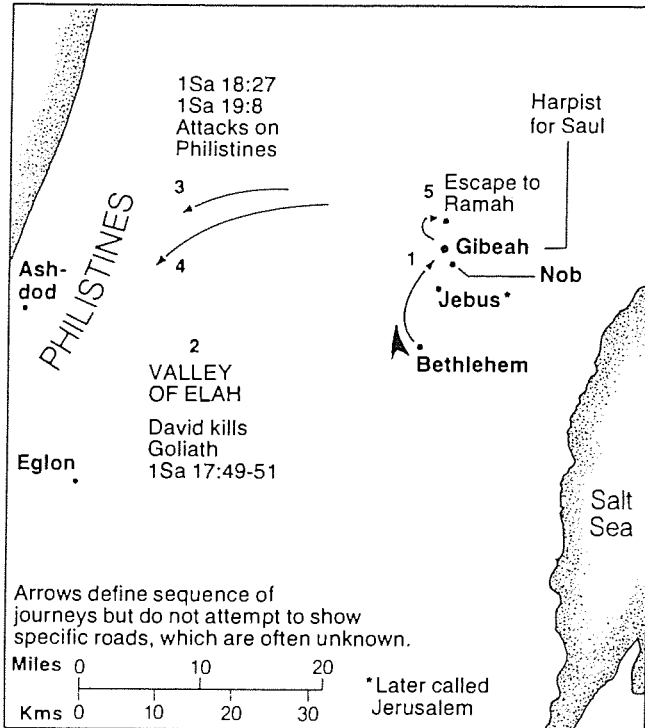

## Exploits of David

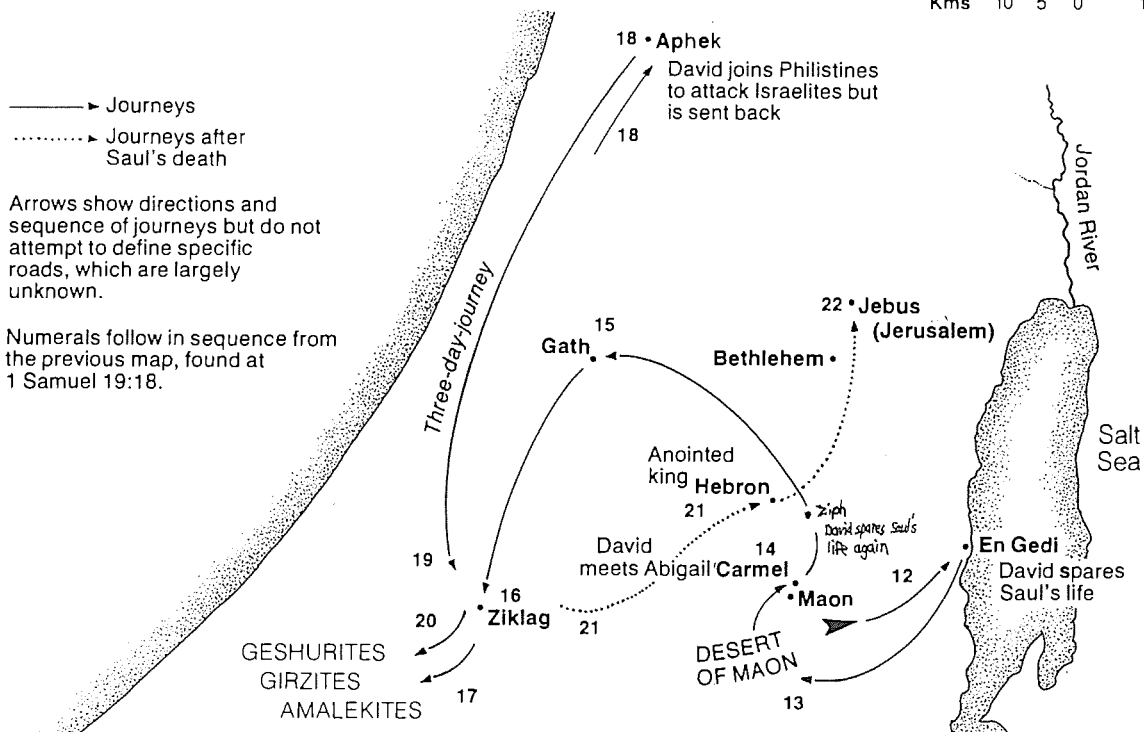
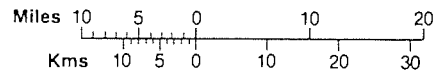

## Saul and David Contrasted

	<b>Saul</b>	<b>David</b>
<i>Tribe/Lineage</i>	Benjamin	Judah
<i>Appointment</i>	People's choice	God's choice
<i>Warfare</i>	Fear: should have killed Goliath	Courageous: killed Goliath
<i>Spirit's Power</i>	Temporary	Permanent
<i>Emotions</i>	Paranoia	Trust
<i>Attitude towards Law</i>	Disobeyed	Obedied
<i>Attitude re: Anointed</i>	"Strike him!"	"Spare him!"
<i>Social Style</i>	Vindictive	Forgiving
<i>Followers' Motivation</i>	Fear	Respect
<i>Leadership</i>	Foolish	Wise
<i>Height</i>	Very tall	Shorter
<i>Age at Appointment</i>	Middle-aged	Teenager
<i>Response to Sin</i>	Regret	Repentance
<i>Marriage</i>	Monogamous?	Polygamist
<i>Philistine Subjugation</i>	Began	Finished
<i>Jerusalem Conquering</i>	Couldn't do it	Made it capital
<i>Size of Kingdom</i>	Small	Huge
<i>Covenant</i>	Rejected (1 Sam. 13:13)	Davidic (2 Sam. 7)
<i>Death</i>	Violent with disgrace	Peaceful with honor

# The Philistine Threat

*Nelson's Complete Book of Bible Maps and Charts*

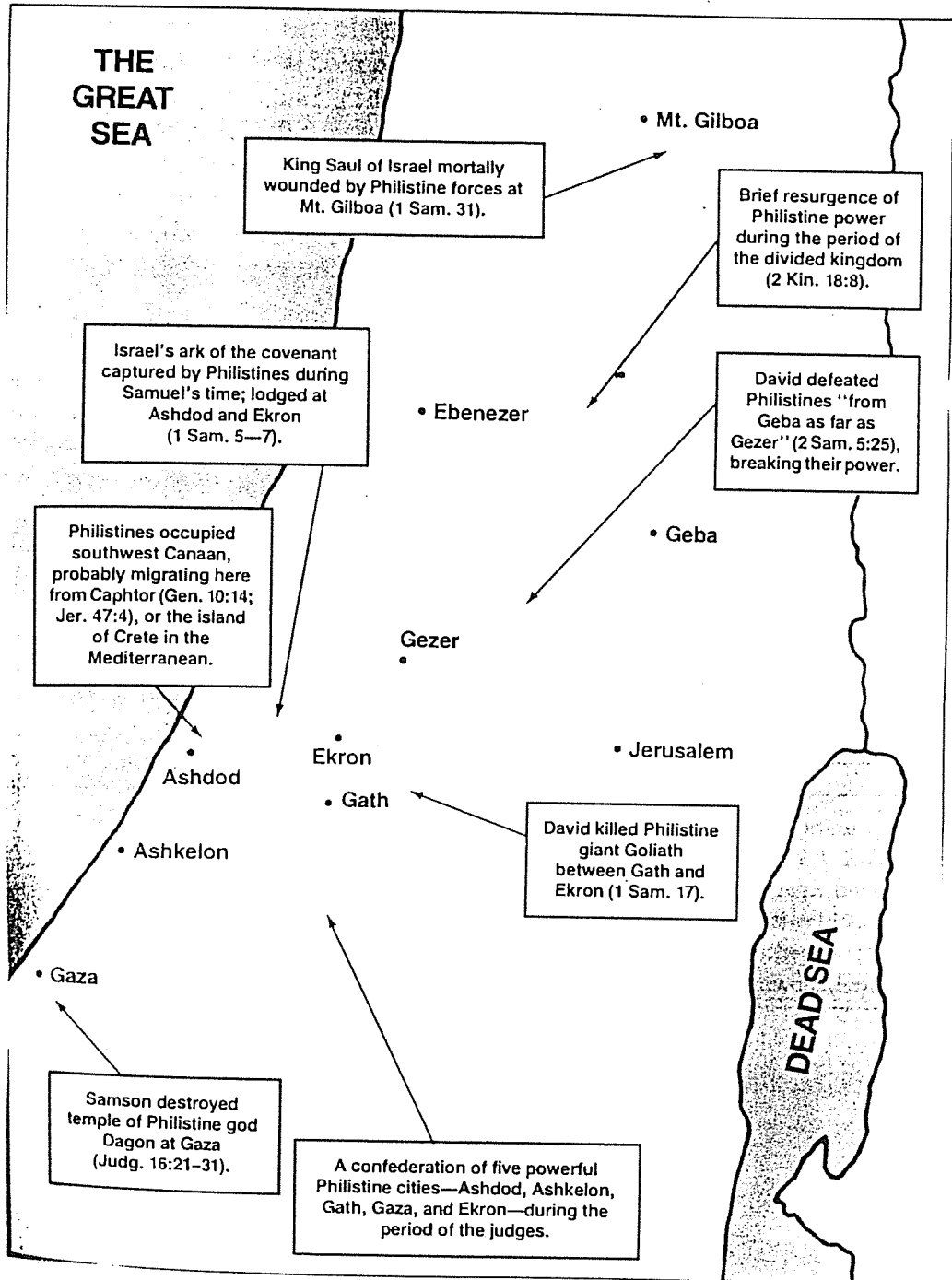

# Controversial Issues

## 1. Did Samuel actually appear to Saul?

### A. Different Interpretations:

#### 1. *Saul and the witch under hallucination*

##### *Response :*

- Impossible for both to hallucinate the same vision at the same time.
- The witch did see Samuel and she was frightened at the sight of him.

#### 2. *The witch deceived Saul into thinking that she called Samuel from the dead.*

##### *Response :*

- Impossible for Saul to be deceived, for he knew Samuel and his voice.
- The witch was frightened at what she saw
- The witch cannot give such accurate prophecy that is attributed to Samuel here

#### 3. *A demon impersonated Samuel*

##### *Response:*

- Demons do not promulgate truth, but deception. The prophecy was proven true to the smallest detail

#### 4. *Samuel actually appeared to Saul*

##### *Support:*

- Saul believed that the apparition was really Samuel
- The prophecy was in accord with what Samuel has said to Saul when Samuel was alive
- the prophecy was fulfilled literally

## 2. If Samuel really did appear to Saul, why would God allow ungodly woman to bring up a man of God and for what purpose?

to make Saul's sin of witchcraft an occasion of his punishment

to demonstrate that God has control over all the spirit world

to warn men of all time to stay away from spiritism

Regulations for monarchy in Deut. 17:14-20

The typology of Christ as King

But everything has to be done according to divine timing and in line with divine criteria

**Controversial Issues (2 of 5)**

A Class Presentation Summary of Walter Kaiser, *Hard Sayings of the OT and More Hard Sayings of the OT*

**3. Was monarchy in Israel part of God's plan?**

- Yes, God intended to establish kingship in Israel.
- God's promise to Abraham in Gen. 17:6,10 : "Kings will come from you.."
- Reaffirmation of the same promise to Jacob in Gen. 35:11
- Jacob's blessing records of this kingship (Gen. 49:10)
- Regulations for monarchy in Deut. 17:14-20
- The typology of Christ as King

But everything has to be done according to divine timing and in line with divine criteria.

**4. If monarchy was part of God's plan for Israel, why was the demand for a king displeasing to Samuel and offensive to God?**

- Because it was not done according to God's timing. God will give them a king in His own time (David?)
- Because their attitude was wrong: "... to be like all the nations.." - a statement of disbelief in the power and presence of God. (reasons for wanting a monarchy)

**5. A chief objective to the view that God of the Old Testament is a God of love and mercy is the divine command to exterminate all men, women and children belonging to the seven and eight Canaanite nations. How, ask most serious readers of the text, could God approve of blanket condemnations, of the genocide of an entire group of people?**

- God had dedicated these people to destruction because they violently and steadfastly impeded or opposed his work over a long period of time. This act of destruction was reserved for the spoils of Southern Canaan (Num 21:2-3), Jericho (Josh 6:21), Ai (Josh 8:26), Makedah (Josh 10:28) and Hazor (Josh 11:11)
- The reason for the delay in the act of destruction was is that "the sin of the Amorites [the Canaanites] has yet reached its full measure.] (Gen.15:13-16)
- These nations were cut off to prevent the corruption of Israel and the rest of the world (Deut 20:16-18). When a nation starts burning children as a gift to the gods (Lev. 8:21) and practices sodomy, bestiality and all sorts of loathsome vices (Lev. 18:25, 27-30), the day of God's grace and mercy has begun to run out.
- God was dead against the Amalekites because while the Israelites were struggling through the desert toward Canaan, the Amalekites picked off the weak, sick and elderly at the end of the line of the march and brutally murdered these stragglers (Deut 25:17-18) They were attacking God's chosen people to discredit the living God.

**Controversial Issues (3 of 5)**

A Class Presentation Summary of Walter Kaiser, *Hard Sayings of the OT* and *More Hard Sayings of the OT*

6. 1 Samuel 15:14:14-15,22 [ ..to obey is better than sacrifice...] and a few other texts appears to repudiate all sacrifices. Though some texts call for burnt offerings to God (e.g. Ex 29:18, 36; Lev. 1-7), others appear to disparage any sacrifices, even as our text in 1 Samuel 15:22 seems to do. How do we reconcile this seeming contradiction?
- Perfunctionary acts of worship and ritual, apart from diligent obedience, were basically worthless to God and the individual. Prophet Isaiah rebuked the nation for their empty ritualism (Is.1:11-15); what was needed was a new heart attitude as the proper preparation for meeting God (Is.1:16-18). Jeremiah records the same complaint (Jer. 6:20).
  - God does approve sacrificing, but he does not wish to have it at the expense of full obedience to his Word or as a substitute for a personal relationship of love and trust. Sacrifices, however, were under the Old Testament economy. As for us, Christ was our sacrifice, once for all (Heb. 10:1-18). Nevertheless the principle is still the same : True religious affection for God begins in the heart and not in acts of worship or the accompanying vestments and ritual.
7. What, then , was the nature of the change in God that 1 Samuel 15:11 talks about, when he says. "I am grieved that I have made Saul king, because he has turned away from me and has not carried out my instructions?" If God is unchangeable, why did he "repent" or "grieve over" the fact that he had made Saul king?

God is not a frozen automation who cannot respond to persons; he is a living person who can and does react to others as much, and more genuinely, than we do to each other. Thus the same word repent, is used for two different concepts both in this passage and elsewhere in the Bible. One shows his responsiveness to individuals and the other shows his steadfastness to himself and to his thoughts and designs. Hence, this text affirms God as remaining true to his own character and essence. Repentance in God is not, as it is in us, an evidence of indecisiveness. It is rather a change in the other individual. The change, then is in Saul. The problem was in Saul's partial obedience, his wayward heart and covetousness. While God repented that he had given Saul the kingdom along with its honour and power, he did not repent giving him wisdom and grace or his fear and love; the gifts and callings of God are without repentance.



**Controversial Issues** (4 of 5)

A Class Presentation Summary of Walter Kaiser, *Hard Sayings of the OT and More Hard Sayings of the OT*

8. King Saul became bereft of the Spirit of God and as a result fell into ugly bouts of melancholia, which was attributed to an evil spirit sent from the Lord (1 Samuel 16:13-14). Saul's bouts of melancholy were attributed to the Lord, what explanation can we give for such a radical shift and reversion of Saul's personality?

Possible answers:

- ✎ <sup>1</sup>Keil and Delitzsch attributed Saul's problem to demon possession. They specify that this "was not merely an inward feeling of depression at the rejection announced to him... but a higher evil power, which took possession of him, and not only deprived him of his peace of mind, but stirred upon the feelings, ideas, imagination, and the thoughts of his soul to such an extent that at times it drove him even into madness. Jehovah sent this evil spirit as a punishment."
- ✎ The evil spirit was a messenger, by analogy with the situation in 1 Kings 22:20-23. This unsuspected messenger did his work by the permission of God.
- ✎ This evil spirit was a 'spirit of discontent' created in Saul's heart by God because of his continued disobedience.

9. Saul's question about the identity of David in 1 Samuel 17 create a rather difficult problem in light of 1 Samuel 16, especially verses 14-23. It would appear from chapter 16 that by the time of David's slaying of Goliath Saul had already been introduced to David and knew him quite well.

Possible answers:

- ⋈ These two accounts stem from independent traditions. Thus the confusion over whether David's debut at court preceded his conquest of the Philistine is unnecessary, since the stories come from different sources and do not intend to reflect what really happened so much as teach a truth.
- ⋈ Some blamed Saul's diseased and failing mental state. On this view, the evil spirit from God had brought on a type of mental malady that affected his memory.
- ⋈ The hustle and bustle of court life, with its multiplicity of servants and attendants, meant that Saul could <sup>have</sup> easily forgotten David, especially if the time was long between David's service through music and his slaying of Goliath.

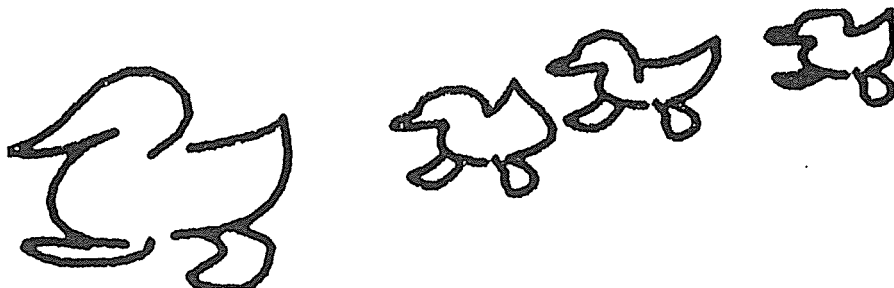

**Controversial Issues (5 of 5)**

A Class Presentation Summary of Walter Kaiser, *Hard Sayings of the OT* and *More Hard Sayings of the OT*

- Saul was not asking for David's identity, instead he was attempting to learn what his father's social position and worth were, for he was concerned what type of stock his future son-in-law might come from.
- The most favoured answer by older commentaries is that the four events in the history of Saul and David in 1 Samuel 16–18 are not given in chronological order. Instead they are transposed, by a figure of speech known as hysteron proteron, in which something is put last that according to the usual order should be put first (e.g. Gen 10 ).<sup>2</sup>E.W. Bullinger suggested that the text was rearranged in order to bring together certain facts, especially about the Spirit of God.

<sup>1</sup> Johann Karl Friedrich Keil and Franz Delitzsch, Biblical Commentary on the Books of Samuel (Grand Rapids: Erdmans, 1950) . p.170

<sup>2</sup> E.W. Bullinger, Figures of Speech (1898; reprint ed. Grand Rapids: Baker, 1968), pp.706-7

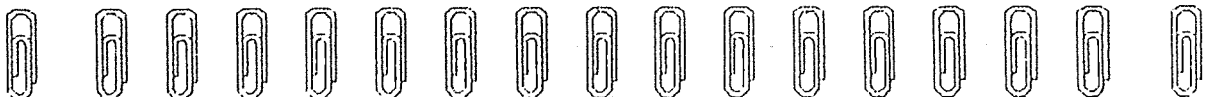

**SOURCES :**

Walter C. Kaiser, Jr. *Hard Sayings of the Old Testament* . Inter-Varsity Press, Illinois

Walter C. Kaiser, Jr. *More Hard Sayings of the Old Testament* . InterVarsity Press, Illinois

Wilmington's Survey of the Old Testament

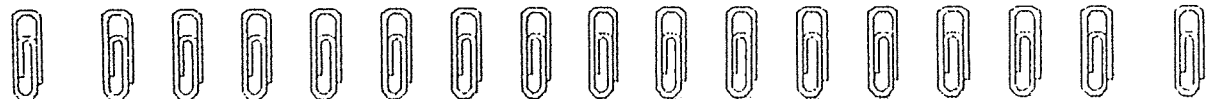

## 2 Samuel

<b>Covenant Kindness Towards the Davidic Dynasty</b>							
Establishment		Sin		Consequences		Appendix	
Triumphs		Transgressions		Troubles		Tribute	
Obedience		Disobedience		Judgment		Summary	
Chapters 1–10		Chapter 11		Chapters 12–20		Chapters 21–24	
Faith	Blessing	Adultery	Murder	Family	Politics	Humility	Pride
1–4	5–10	11:1-5	11:5-27	12–14	15–20	21–23	24
Over Judah	Over All Israel						
From Hebron	From Jerusalem						
7 1/2 Yrs. (1011-1004 BC)	33 Years (1004-971 BC)						

**Key Word:** Covenant

**Key Verse:** “When your [David’s] days are over and you rest with your fathers, I will raise up your offspring to succeed you, who will come from your own body, and I will establish his kingdom. He is the one who will build a house for my Name, and I will establish the throne of his kingdom forever” (2 Samuel 7:12-13).

**Summary Statement:**

God establishes David as king and protects his dynasty despite punishing David's sin and the rivals to the throne to show His justice and faithfulness to fulfill His purposes through His *covenant kindness shown to David and his seed*.

**Application:**

God blesses the obedient but judges the disobedient.

# 2 Samuel

## Introduction

Note: The introduction in some part reiterates the introduction to 1 Samuel.

I. **Title** The name "Samuel" (שְׁמוּאֵל *semuel*) means "name of El [God]" or "his name is El [God]" (BDB 1028d 1) from the compound of שָׁמַי, "name," and אֱלֹהִים, "El," the singular form of אֱלֹהִים, "Elohim." It also sounds similar to the Hebrew for "ask, inquire" (from שָׁאַל 1 Sam. 1:20). The Books of Samuel in the earliest Hebrew manuscripts formed a single scroll simply entitled "Samuel" after the first important character in the account. The Septuagint was the first translation to divide the book into two with the titles *First Kingdoms* and *Second Kingdoms*. *First and Second Kings* then followed with the titles *Third Kingdoms* and *Fourth Kingdoms*.

### II. Authorship

- A. **External Evidence:** The Jewish Talmudic tradition ascribed the authorship of *First and Second Samuel* to Samuel, but he could not have written beyond 1 Samuel 25:1 since this verse records his death. *First Chronicles* 29:29 refers to "the Book of Samuel the Seer," "the Book of Nathan the Prophet," and "the Book of Gad the Seer." This may refer to the threefold authorship of the Books of Samuel that may have been compiled in their final form by a member of the prophetic school. Since they originally formed a single scroll entitled "Samuel," this may account for his name being attached to both books.
- B. **Internal Evidence:** The book provides little, if any, evidence to identify the author(s), so it must be considered anonymous. Perhaps, as mentioned above, Nathan and/or Gad recorded the account.

### III. Circumstances

- A. **Date:** Although 1 Samuel 1—24 was recorded by Samuel at the end of his life (born ca. 1105 BC, died ca. 1015 BC), the remainder of the Books of Samuel must have been composed over 85 years later following the division of the kingdom between Israel and Judah in 931 BC. This is indicated by references to the divided monarchy (1 Sam. 11:8; 17:52; 19:16; 2 Sam. 5:5; 11:11; 12:8; 19:42-43; 24:1, 9) and the reference to Ziklag, a Philistine city that the writer says, "has belonged to the kings of Judah to this day" (1 Sam. 27:6). In regard to the *latest* possible date of composition, the absence of reference to the fall of Samaria in 722 BC is notable. Therefore, the time of final composition most likely falls between 931 BC and 722 BC.
- B. **Recipients:** As the Books of Samuel mention the divided monarchy (see above), those who read the books in their final form must have lived shortly after the reigns of David and Solomon. As inhabitants of a divided kingdom, the account of when the nation was unified under one king would have proved valuable from a historical context.
- C. **Occasion:** The second half of the Books of Samuel pick up right where the first left off: there is no real break between 1 Samuel 31:13 and 2 Samuel 1:1. Although God's approval of the Davidic dynasty is veiled in 1 Samuel 1-15, this theme is clearly portrayed in 1 Samuel 16 to 2 Samuel 24. Therefore, in 2 Samuel the purpose is to defend the Davidic dynasty (cf. 2 Sam. 7), especially during the era when two reigns coexisted in the north and the south. Whereas nine dynasties eventually reigned in the northern kingdom, God, true to His promise (2 Sam. 7:4-17), sustained the southern kingdom under one dynasty—David's.

### IV. Characteristics

- A. *Second Samuel* paints a very real picture of David—strengths and weaknesses alike. While it lists his greatest accomplishments (chs. 1-10), it also does not hide his greatest failures (ch. 11). This chapter is the turning point of the book after which it's mostly downhill.

- B. David in 2 Samuel is one of the most important types of Jesus Christ in the Old Testament. In particular, David seeks to build a house *for God*, which the LORD refuses in order to build a “house” *for David* (7:4-17), called the Davidic Covenant. The Davidic Covenant also finds its source in the Abrahamic Covenant and is a further expansion of the original seed promise to Abraham (cf. notes, 61). God's promise of a seed to Abraham (Gen. 12:1-3) from his own body (Gen. 15:1-9) that will become a great nation is further explained in His promise to David (2 Sam. 7:10-16). The Davidic Covenant guarantees David that each king who will sit on the throne of Israel will be one of his direct descendants. Also, since this covenant is eternal (v. 16), it guarantees Israel that in the future a descendant of David will again occupy the throne in the kingdom—none other than our King Jesus (see. also p. 218a).

## Argument

Second Samuel continues the argument of First Samuel: that God is working out His divine purposes through the covenant kindness shown to David and his seed. This is seen in the triumphs of David as ruler over a renewed kingdom (chs. 1–10) and God's faithfulness despite David's sin (ch. 11). This sin is judged (chs. 12–20), but never is the dynasty taken away as was the case with Saul (since the Davidic Covenant amplifies the unconditional Abrahamic Covenant and thus is also unconditional). A final section (chs. 21–24) serves as an appendix of David's final years to provide additional accounts of his failures and successes as indication of God's continued blessing upon his line while still punishing sin. Throughout the account God delegates dominion or sovereignty first to David, which sets the stage for the same authority delegated to his descendants who later also sit on the throne in Jerusalem in the books of Kings and Chronicles.

In regard to spiritual truths in 2 Samuel, the most prominent one reiterates the cause and effect principle stated in every book since Genesis: obedience (chs. 1–7) always brings God's blessings (chs. 8–10), but disobedience (ch. 11) always brings His judgment (chs. 12–24; *TTTB*, 78).

## Synthesis

### Covenant kindness towards Davidic dynasty

<b>1–10</b>	<b>Establishment</b>	
1–4	Over Judah at Hebron	
1	Respect for Saul	
2:1-11	Ish-Bosheth crowned	
2:12–4:12	Rivals eliminated—refusal of force	
5–10	Over all Israel at Jerusalem with new...	
5	Capital	(Jerusalem)
6	Worship center	(Ark moved)
7	Dynasty	(Davidic Covenant)
8	Boundary	(Kingdom Expansion)
9	Son	(Mephibosheth)
10	Vassals	(Ammon and Syria)
<b>11</b>	<b>Sin</b>	
11:1-5	Adultery	
11:6-26	Murder	
11:27	Illegitimate son	
<b>12–20</b>	<b>Consequences</b>	
12–14	Family troubles	
12	Son dies	(Solomon chosen)
13	Amnon (immorality)/Absalom (murder)	(Rival eliminated)
14	Estrangement	
15–20	Political troubles	
15–18	Absalom's rival	(Rival eliminated)
15:1–16:14	Absalom's self-coronation	
16:15–17:29	Hushai's bad advice	

18	Joab kills Absalom
19–20	David's restoration
19	Returned but divided
20	Joab kills Sheba
<b>21–24</b>	<b>Appendix</b>
21:1-15	Famine over Gibeonite oath
21:16-22	Victories
22:1–23:7	Song/Last words
23:8-39	Mighty men
24	Census

## Outline

### Summary Statement for the Book

God establishes David as king and protects his dynasty despite punishing David's sin and the rivals to the throne to show His justice and faithfulness to fulfill His purposes through His *covenant kindness shown to David and his seed*.

- I. (Chs. 1–10) God establishes David as king over a renewed, perpetual kingdom as evidence of His blessing upon him and his dynasty.
  - A. (Chs. 1–4) David reigns over Judah at Hebron after Saul's death and allows God to prepare for him the entire kingdom without force.
    1. (Ch. 1) David receives word of the deaths of Saul and Jonathan, kills the messenger, and laments as an expression of his respect for the divinely inaugurated kingship.
    2. (2:1-11) After David is crowned king of Judah at Hebron, Saul's commander Abner crowns Saul's son Ish-Bosheth king over Judah contrary to God's purpose.
    3. (2:12–4:12) David refuses to take the kingdom by force but allows God to take care of rivals to the throne as an example of sincere trust in God.
      - a. (2:12–3:39) Abner initially fights David's commander Joab but then defects to David's side and is killed by Joab, thus removing a potential rival to the throne.
      - b. (Ch. 4) The murderers of Ish-Bosheth are killed by David as punishment for seeking to seize David's kingdom for him by force.
  - B. (Chs. 5–10) David reigns over all Israel at Jerusalem and renews the kingdom as evidence of God's blessing upon him and his dynasty.
    1. (Ch. 5) David becomes king over all Israel and defeats the Jebusites and Philistines, establishing Jerusalem as the new capital.
    2. (Ch. 6) Jerusalem also becomes the new worship center when the ark is brought from Kiriath-Jearim.

Service	Man's Way	God's Way
Mode of Transporting the Ark	Dishonored God by use of cart (6:3)	Honored God by having priests carry it by hand (6:13)
David's Role	King who forces priests to go against biblical commands	King who honors priests
Results	Uzzah dies trying to stabilize the cart (6:6); blessing goes to Obed-Edom instead of David (6:11)	Rest from enemies (7:1, 11) Nation united under God

3. (Ch. 7) When David seeks to build a house for God, the LORD promises to build "a house" *for him* as the father of a new dynasty which will last forever (i.e., the Davidic Covenant).
4. (Ch. 8) David expands the kingdom with a new boundary through military victories in the north and south as God's fulfillment of His promise to give Israel rest from its enemies.
5. (Ch. 9) Jonathan's son Mephibosheth receives the honor of being a new son to David as David's act of tribute to the house of Saul.
6. (Ch. 10) David defeats Ammon and Syria because they refuse his kindness and as a result he acquires new vassals.

**II. (Ch. 11) David sins against God through adultery and murder as indication of his sinful, fallen nature, despite the divine choice of his dynasty.**

- A. (11:1-5) David commits adultery with Bathsheba which results in a problem pregnancy.
- B. (11:6-26) David murders Uriah the Hittite—a loyal husband and soldier—in an effort to cover his sin which shows how low even divinely commissioned servants can get.
- C. (11:27) David marries Bathsheba, who bears him an illegitimate son.

**III. (Chs. 12–20) David experiences serious family and political consequences for his sin yet God still allows him to keep the kingdom by eliminating all rivals to the throne due to His promise to show both His justice and faithfulness.**

- A. (Chs. 12–14) David's sin results in family troubles through the deaths of two of his sons, incest, and estrangement to teach the consequences of disobedience to God's covenant and to show God's commitment to eliminate Amnon as a rival to David's throne.
  1. (Ch. 12) The unnamed son of David and Bathsheba dies in fulfillment of Nathan the prophet's words, but God gives them another son—Solomon—to whom the covenant promise will pass, thus demonstrating both the severity and grace of God.
  2. (Ch. 13) David's son Amnon repeats David's immorality with Bathsheba by raping his half-sister Tamar and David's son Absalom repeats David's murder of Uriah by murdering Amnon to teach the consequences of disobedience to God's covenant.
  3. (Ch. 14) David is estranged from Absalom for two years even after Absalom returns to Jerusalem.
- B. (Chs. 15–20) David's sin results in political troubles from Absalom's and Sheba's rebellions, yet God restores the kingdom to him to protect the Davidic dynasty to show God's commitment to eliminate Absalom as a rival to David's throne.
  1. (Chs. 15–18) Absalom rivals his father's throne but David refuses to protect his kingdom by force, resulting in Absalom's death and the protection of the Davidic dynasty.
    - a. (15:1–16:14) Absalom wins over many in Israel and declares himself king, which forces David from Jerusalem into exile since he is unwilling to protect his kingdom by force.
    - b. (16:15–17:29) Absalom follows Hushai's bad advice to wait to fight David instead of Ahithophel's good advice to attack David immediately as God's design to protect David from harm.

- c. (Ch. 18) David's men defeat Absalom's army and Joab kills his cousin Absalom but David mourns his death, demonstrating God's protection of the Davidic dynasty as Absalom had no sons.
2. (Chs. 19–20) David's kingdom is restored to him by returning to Jerusalem and subduing Sheba's rebellion in the north, which protects the Davidic dynasty as evidence of the faithfulness of God.
  - a. (Ch. 19) David returns to Jerusalem with a restored kingdom but the division between the northern and southern tribes remains.
  - b. (Ch. 20) The northern tribes follow Sheba the Benjamite in rebellion and Joab regains his commander position by murdering Amasa and Sheba, thus reestablishing David's rule over the entire kingdom.

**IV. (Chs. 21–24) An appendix of David's final years provides additional accounts of his failures and successes as indication of God's continued blessing upon his line while still punishing sin.**

- A. (21:1-14) A three-year famine strikes Israel because of Saul's breaking the Gibeonite covenant, so David kills seven of Saul's sons to appease the Gibeonites and the famine stops, thus demonstrating David's commitment to fulfilling oaths.
- B. (21:15-22) David's victories over the Philistines and the killing of the rest of Goliath's family in his later years is provided to show the completeness of David's victories due to God's blessing on his life.
- C. (22:1–23:7) David's song of praise and last words supplement the historical accounts to demonstrate his faithful and humble trust in God's deliverance—not in his own power.
  1. (Ch. 22) David's song of praise for deliverance from his enemies and Saul supplements the historical accounts to demonstrate his faithful and humble trust in the LORD's deliverance rather than in his own power.
  2. (23:1-7) David's last words supplements the historical accounts to demonstrate his faithful and humble trust in the LORD's deliverance rather than in his own power.
- D. (23:8-39) A list of David's famous soldiers is given to conclude the military summary of his reign.
- E. (Ch. 24) David sins by taking a census of his fighting men to boast in his human military might, which receives God's judgment through a plague killing 70,000 Israelites up to the site where the temple was soon built.

Note: Adonijah, the third and final rival to the Davidic throne, is also eliminated by Solomon to protect the Davidic dynasty in 1 Kings 1–2.

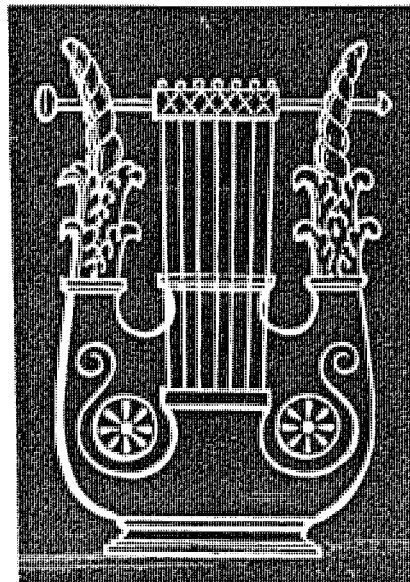



# Geography of David's Jerusalem

*The Bible Visual Resource Book, 63; Biblical Archaeology Review (July/Aug '94): 24*

Substantial historical evidence, both Biblical and extra-Biblical, places the temple of Herod (and before it the temples of Zerubbabel and of Solomon) on the holy spot where King David built an altar to the Lord. David had purchased the land from Araunah the Jebusite, who was using the exposed

bedrock as a threshing floor (2Sa 24:18-25). Tradition claims a much older sanctity for the site, associating it with the altar of Abraham on Mount Moriah (Ge 22:1-19). The writer of Genesis equates Moriah with "the Mountain of the LORD," and other OT shrines originated in altars erected by Abraham.

### c. 1000 B.C.

Barely 12 acres in size, Jebus, a Canaanite city, could well defend itself against attack, with walls atop steep canyons and shafts reaching an underground water source. David captured the stronghold, c. 1000 B.C. and made it his capital.

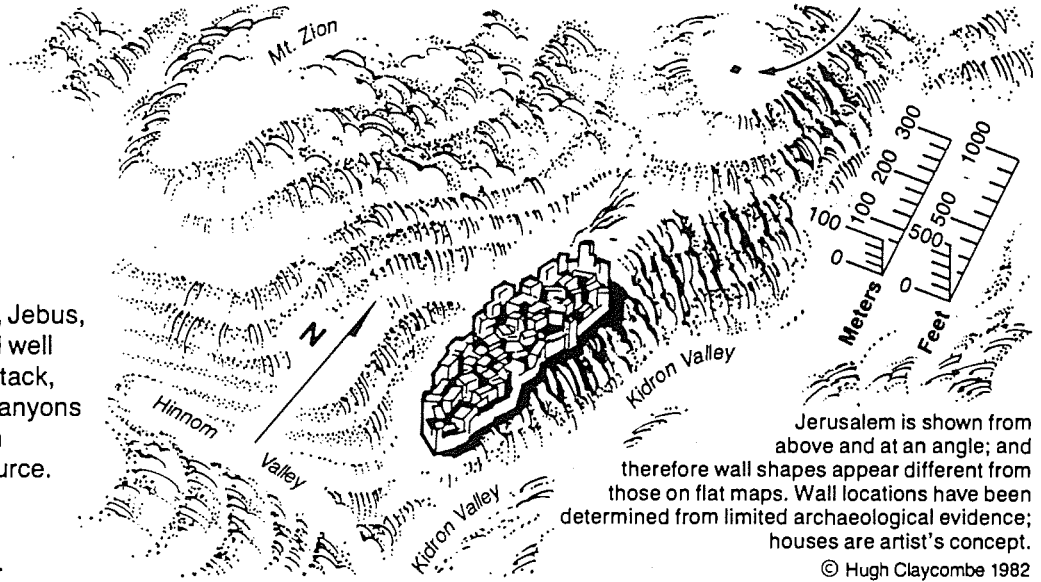

Jerusalem is shown from above and at an angle; and therefore wall shapes appear different from those on flat maps. Wall locations have been determined from limited archaeological evidence; houses are artist's concept.

© Hugh Claycombe 1982

For further reference to the development of Jerusalem see: page 73, *Solomon's Jerusalem*; page 99, *Jerusalem of the Returning Exiles*; page 139, *Jerusalem During the Time of the Prophets*.

## Mysteries of the Warren's Shaft System

These drawings show the Warren's Shaft system as viewed in section, as though we could look at a vertical cutaway of the hill, and in plan, as if seen from above. The construction of the system required blockage of the outlet to the Kidron Valley (originally a natural drain for the Gihon Spring) and the engineering of the lower

tunnel to bring the water into the "water chamber" at the foot of Warren's Shaft. This allowed Warren's Shaft to function as a well. Even during a siege, people within the city (note the position of the Jebusite and Israelite city walls) could walk down the steep upper tunnel, then through the more moderately sloped tunnel to the top of Warren's Shaft, from which they could lower a bucket to raise water from the water chamber, 37 feet below.

*Joab probably used the water shaft (Warren's Shaft) to get into the city (2 Sam. 5:8)*

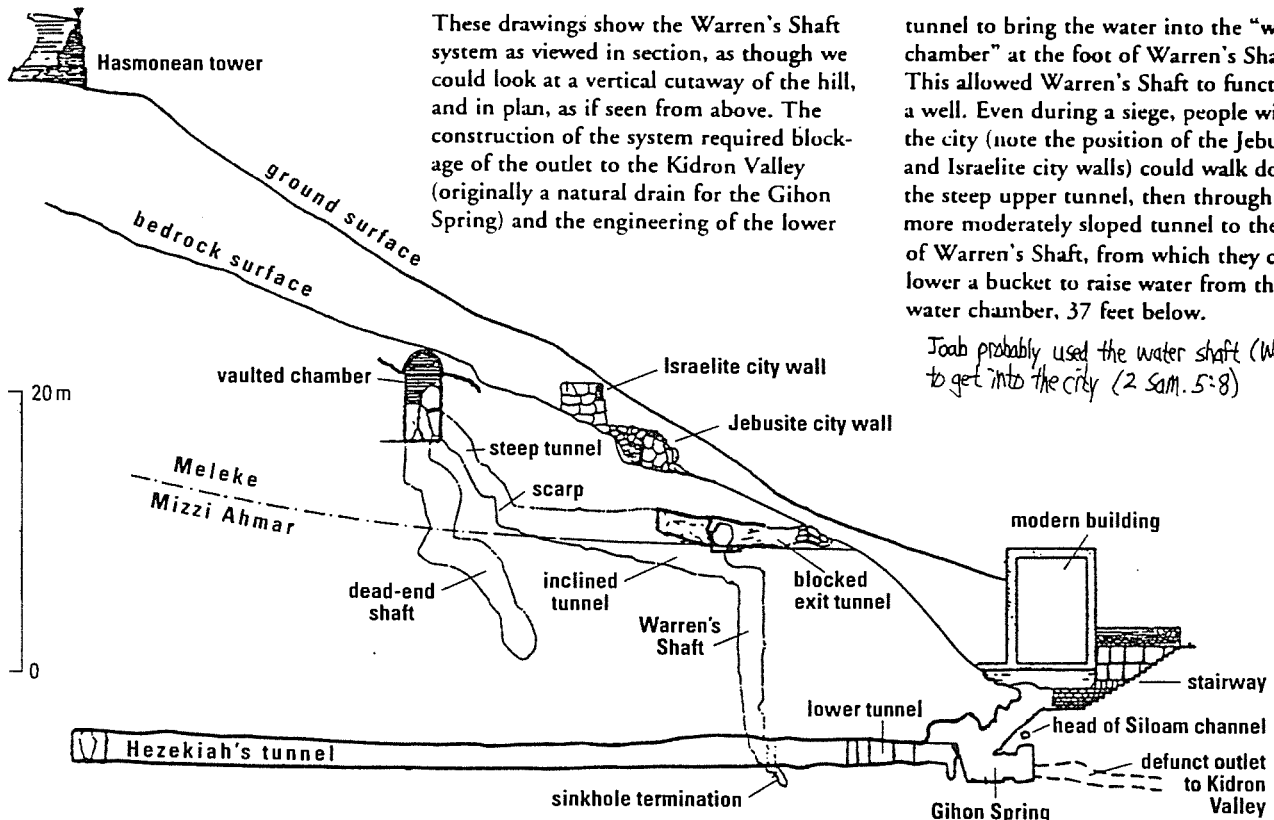

# David's Conquests

The Bible Visual Resource Book, 64

2 Samuel

## David's Conquests

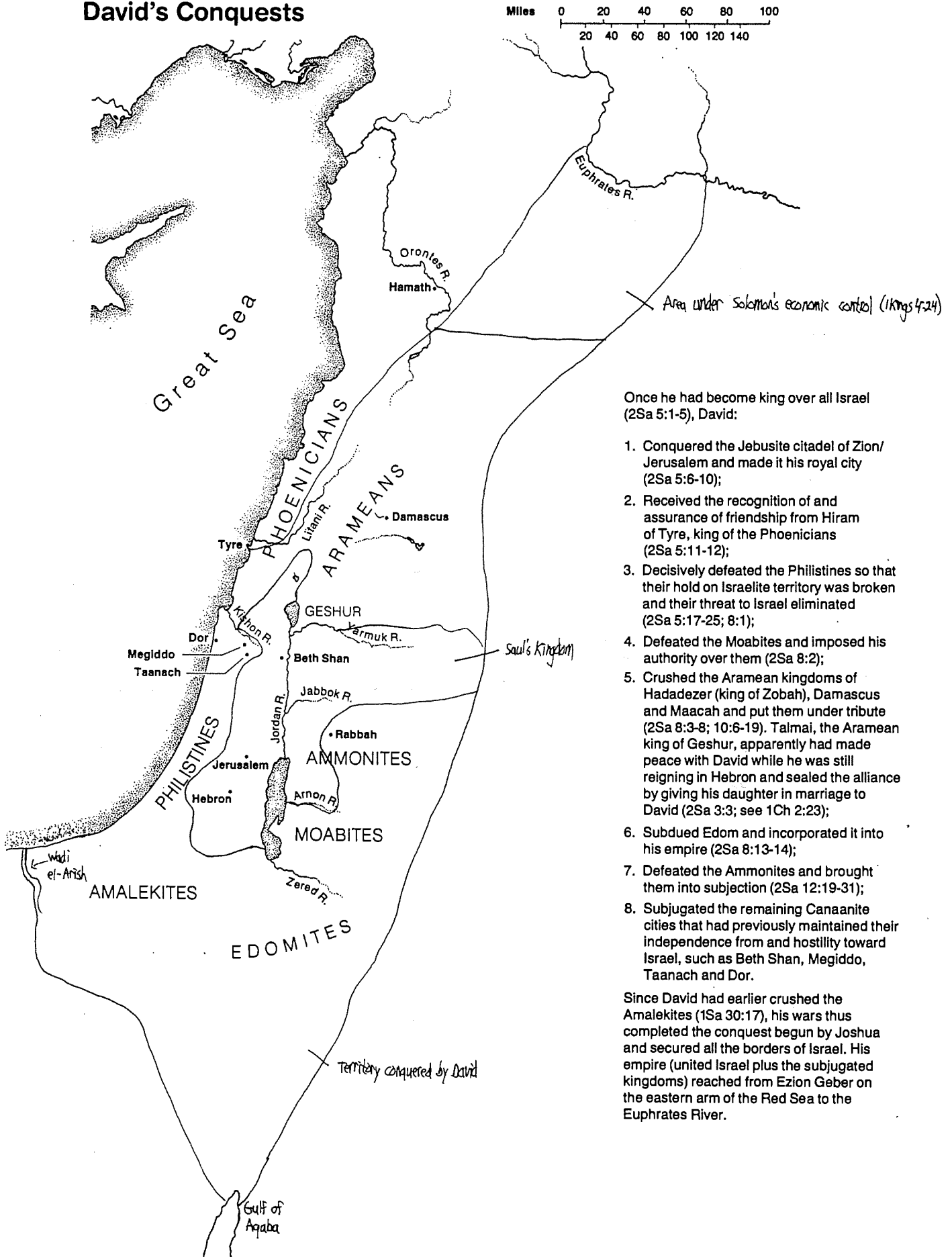

Once he had become king over all Israel (2Sa 5:1-5), David:

1. Conquered the Jebusite citadel of Zion/ Jerusalem and made it his royal city (2Sa 5:6-10);
2. Received the recognition of and assurance of friendship from Hiram of Tyre, king of the Phoenicians (2Sa 5:11-12);
3. Decisively defeated the Philistines so that their hold on Israelite territory was broken and their threat to Israel eliminated (2Sa 5:17-25; 8:1);
4. Defeated the Moabites and imposed his authority over them (2Sa 8:2);
5. Crushed the Aramean kingdoms of Hadadezer (king of Zobah), Damascus and Maacah and put them under tribute (2Sa 8:3-8; 10:6-19). Talmi, the Aramean king of Geshur, apparently had made peace with David while he was still reigning in Hebron and sealed the alliance by giving his daughter in marriage to David (2Sa 3:3; see 1Ch 2:23);
6. Subdued Edom and incorporated it into his empire (2Sa 8:13-14);
7. Defeated the Ammonites and brought them into subjection (2Sa 12:19-31);
8. Subjugated the remaining Canaanite cities that had previously maintained their independence from and hostility toward Israel, such as Beth Shan, Megiddo, Taanach and Dor.

Since David had earlier crushed the Amalekites (1Sa 30:17), his wars thus completed the conquest begun by Joshua and secured all the borders of Israel. His empire (united Israel plus the subjugated kingdoms) reached from Ezion Geber on the eastern arm of the Red Sea to the Euphrates River.

## Did God Approve of David's Polygamy?

Thomas S. Piper, *Good News Broadcaster* (Feb. 1977): 28  
(See also page 245 of these notes)

### Bible Questions Answered ■ Thomas S. Piper

2 Samuel 1

#### Did God Condone Polygamy?

*Q. While reading in II Samuel 12, I noticed that Nathan said to David, "I gave thee . . . thy master's wives into thy bosom" (v. 8). David already had multiplied wives unto himself, and here the Bible says God gave him more women! This all seems contrary to God's law in Deuteronomy 17:17 and what Jesus said in Matthew 19:9. Why would God seem to go against His own word? I know God wouldn't be inconsistent, so I know there must be an answer! The idea of polygamy seems abhorrent to me.*

A. It helps to consider the whole context of II Samuel 12. According to the opening verses, Nathan was giving David a lesson from God in the form of a parable—that is, a story which carries a central truth alongside it. Nathan presented the parable so effectively that David thought it was a true incident, and he even became angered at the story's villain, only to find that the story was a parable about himself and his evil treatment of Uriah.

Then Nathan twisted the knife, so to speak, by emphatically denouncing David. I can just hear Nathan speaking out in crisp and clear statements for God. They are short but pungent. Notice verses 7-12.

Nathan points out that God, who chose and made David king in the first place, had demonstrated His ability and power in the process. He had given David all he needed to carry out his reign for God over this whole people who are special and dear to the heart of God.

In verse eight, about which you asked, Nathan quotes God as saying that He had given David his master's wives into David's "bosom." I think Nathan was speaking in general terms here. He was saying that God had given David the general power to dispose of, or to govern, even the

most intimate and/or cherished aspects of the previous king's household and empire. Only a sovereign God could accomplish such a thing for someone of such lowly birth as David.

This was to startle David into realizing more vividly that his position and ministry to Israel as king had been brought about *only* by the power of God. None of the credit could go to David or to his ability in climbing the ladder to success and leadership.

I have three main reasons for thinking that we should interpret this passage in this way. The *first* is the *context*. It is true that the translation "wives into your bosom" is a good one. But remember that we must always try to understand Bible word meanings in harmony with the overall meaning or purpose of the writer.

We must ask ourselves, What was the basic reason for Nathan's speech? It was to communicate to David that, as God's appointed leader for that era, he had made a bad mistake. David needed to understand that God had witnessed every wrong action he had taken. By this parable God was demanding that it be straightened out immediately so that David could be cleansed and continue to lead Israel in a spiritual manner.

So then, to interpret verse eight in light of this overall meaning, "bosom" must simply refer to the fact that David was given a general responsibility for these wives. It doesn't imply any kind of intimate relationship or marriage in this instance. If we understand this, we see that God did not go against His own word, as it at first appears.

I found it interesting that the New American Standard Bible translators must also have taken this as the meaning, for they translated "bosom" as "care." This shows that they too must have felt that, although the Hebrew word

literally means "bosom," it was used in this passage to convey the meaning of general care of these wives.

My *second* reason for interpreting the passage in this way is my understanding of the *customs* of that day. Many of the conquered peoples became the possessions of the victors, who could do with them as they wished. It was the custom of the conquering king to fully demonstrate his victory by even taking control of the defeated king's household. Sometimes much of the household, including the wives and children, was given away to the conquering king's captains and friends.

Very seldom would these new possessions be thought of as being on the same level as the victor's own wives and children. The new possessions were relegated to an inferior level and often became common slaves. This helps us get a better insight into this ancient culture and its inhumane (to today's free peoples) treatment of conquered peoples. And if we can force our minds to envision these uncivilized methods of forced subjugation, we should also see that God did not give David a bunch of beautiful wives with whom to enter into intimate relationships. If we can, in our mind's eye, put ourselves back into that day, we will realize that this passage has nothing to do with polygamy but only with God's sovereignty and grace.

The *final* reason for my interpretation is the teaching in *all other Scripture*. You mentioned Deuteronomy 17:17 and Matthew 19:9 as verses which teach that God does not condone polygamy, and I agree that they are appropriate. Our God is unchanging. When He reveals a principle about His values in one part of the Bible, we can be assured that this will be consistently reflected throughout the Word. ■

<h1 style="margin: 0;">Narrative Emphasis in the History of the United Monarchy</h1>			
	SAUL	DAVID	SOLOMON
<b>APPOINTMENT</b>	<ol style="list-style-type: none"> <li>1. By Samuel</li> <li>2. Public process</li> <li>3. Activated by the Spirit</li> </ol>	<ol style="list-style-type: none"> <li>1. By Samuel</li> <li>2. Long process</li> <li>3. By people</li> </ol>	<ol style="list-style-type: none"> <li>1. By David</li> <li>2. By Zadok and Nathan</li> </ol>
<b>SUCCESSSES AND POTENTIAL</b>	Victory over Ammonites	<ol style="list-style-type: none"> <li>1. Taking of Jerusalem</li> <li>2. Defeat of Philistines</li> <li>3. Bringing ark back</li> <li>4. Covenant</li> <li>5. Expansion of empire</li> </ol>	<ol style="list-style-type: none"> <li>1. Dream and request for wisdom</li> <li>2. Wisdom and administration of empire</li> <li>3. Building of temple</li> </ol>
<b>FAILURES</b>	<ol style="list-style-type: none"> <li>1. Impatient offering</li> <li>2. Placing people under improper oath</li> <li>3. Disobeying instructions in Amalekite war</li> </ol>	<ol style="list-style-type: none"> <li>1. Adultery with Bathsheba and murder of Uriah</li> <li>2. Wrongful taking of census</li> </ol>	<ol style="list-style-type: none"> <li>1. Foreign wives' religious practices accommodated</li> <li>2. Labor and tax on people</li> </ol>
<b>RESULTS OF FAILURES</b>	Bad judgment, incompetence, and jealousy	<ol style="list-style-type: none"> <li>1. Bloodshed within family (Amnon, Absalom, Adonijah)</li> <li>2. Rebellion in kingdom (Absalom, Sheba)</li> </ol>	<ol style="list-style-type: none"> <li>1. Military problems</li> <li>2. Division of kingdom</li> </ol>

### Timelines of 2 Samuel

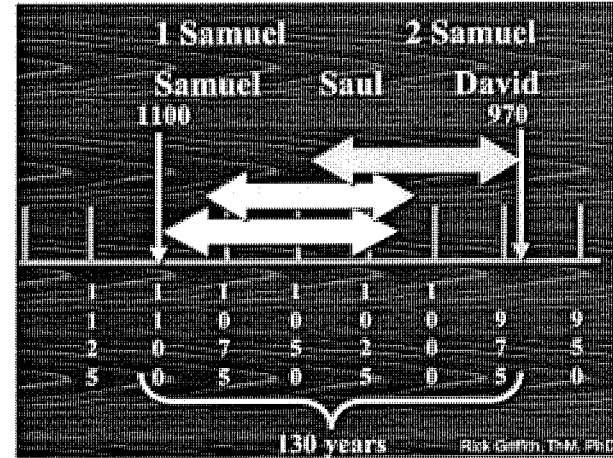
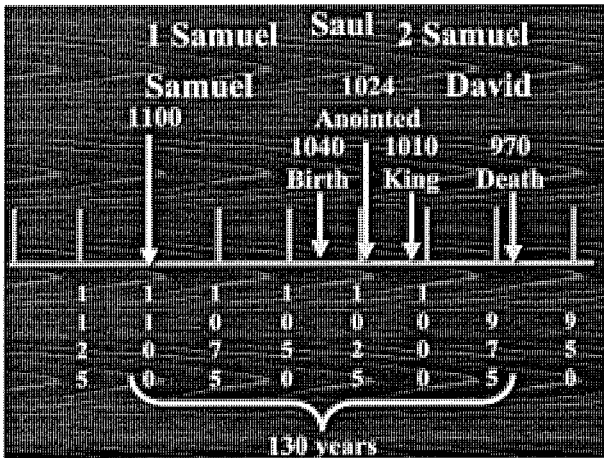
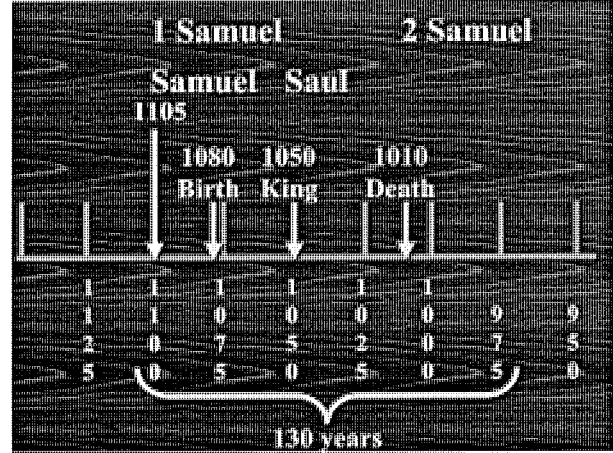
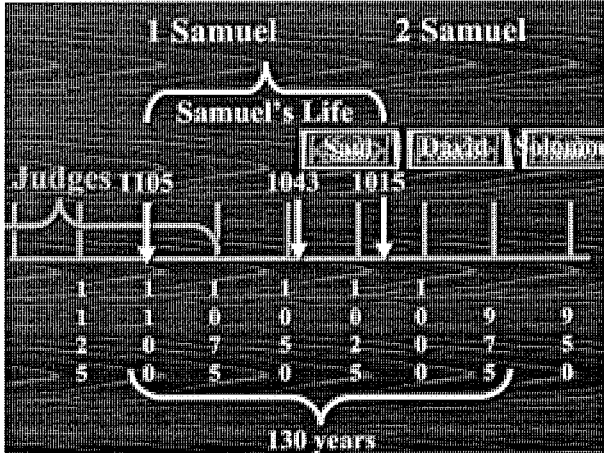

- 1375 Judges begin to rule
- 1100? Samuel born
- 1080 Saul born
- 1050 Saul becomes king
- 1040 David born (when Saul 40 years old)
- 1024 David anointed (Saul 56 years old approx.)
- 1010 Saul dies; David made king over Judah
- 1003 David becomes king over all Israel
- 997? David and Bathsheba sin
- 991 Solomon born (David age 49)
- 980? David's census
- 970 David dies; Solomon made king
- 930 The kingdom is divided

# 1 Kings

<b>Division of the Kingdom</b>						
Late United Kingdom			Early Divided Kingdom			
Chapters 1–11			Chapters 12–22			
Solomon			Split			
Mostly Obedience			Mostly Disobedience			
Yahweh Worship			Idol Worship			
Kingdom in Tranquillity			Kingdoms in Turmoil			
Single Capital: Jerusalem			Israel’s Capital: Samaria Judah’s Capital: Jerusalem			
40 Years (971-931 BC)			80 Years (931-852 BC)			
Established: Purging 1–2	Rise: Obedience 3–8	Decline: Disobedience 9–11	“J & R” Kings 12–14	Other Kings 15:1– 16:28	Ahab vs. Elijah 16:29– 22:40	Other Kings 22:41-53

**Key Word:** Division

**Key Verse:** “But I will not take the whole kingdom out of Solomon’s hand; I have made him ruler all the days of his life for the sake of David my servant, whom I chose and who observed my commands and statutes. I will take the kingdom from his son’s hands and give you [Jeroboam] ten tribes” (1 Kings 11:34-35)

**Summary Statement:**

Solomon’s prosperity from loyalty to the Law ends in disobedience which causes the division of the kingdom with mostly evil kings in Israel and Judah to remind Judah of God's loyalty to the Davidic Covenant and its own need to obey the Law.

**Application:**

The test of a true servant of God is the ability to end well.

Discerning people of God learn from the mistakes of their predecessors and do not repeat these sins themselves.

# 1 Kings

## Introduction

I. **Title** First and Second Kings originally comprised only one book in the Hebrew canon called "Kings" (מְלָכִים) after the first word in 1:1 ("Now King"; וְהַיּוֹם). However, this single scroll was arbitrarily divided in the Septuagint (250 BC) since the Greek required a greater amount of scroll space. The Septuagint titles were Third and Fourth Kingdoms (since 1 and 2 Samuel were designated 1 and 2 Kingdoms). Jerome called 1 and 2 Kings "The Book of the Kings" about six centuries later. These titles are appropriate as these books record and interpret the reign of every king of Israel and Judah except Saul (David has brief mention in 1 Kings 1:1–2:12).

## II. Authorship

- A. **External Evidence:** Jewish tradition ascribes the authorship of the Books of Kings to Jeremiah, and this gains weight from literary parallels between this record and the prophecy of Jeremiah.
- B. **Internal Evidence:** The prophetic-like descriptions of Israel's apostasy indicate that the author was a prophet/historian. Also, this compiler had several historical documents at his fingertips: "the book of the acts of Solomon" (1 Kings 11:41), "the book of the chronicles of the kings of Israel" (1 Kings 14:19), and "the book of the chronicles of the kings of Judah" (1 Kings 14:29; 15:7). These books may be attributed to the official secretary Shebna and/or the official recorder Joah, son of Asaph (2 Kings 18:18; cf. Isa. 36:11). Parallels between 2 Kings 18–20 and Isaiah 36–39 also reveal that Isaiah's scroll also was a source. No firm evidence exists to refute the tradition that Jeremiah authored the Book of Kings.

## III. Circumstances

- A. **Date:** Three lines of evidence indicate that First Kings and even most of Second Kings was written before the Babylonian Captivity (586 BC). The ark still resided in Solomon's temple (1 Kings 8:8), Israel was still in rebellion against Judah (1 Kings 12:19), and Samaria's idolatry persisted even after its resettlement (2 Kings 17:34, 41). However, the final two chapters of Second Kings record up to 26 years after this captivity and may have been recorded by a Jewish captive in Babylon or by Jeremiah himself, who would have been at least 84 years old.

First Kings covers a period of history totaling 120 years, beginning in 971 BC with the inauguration of Solomon and ending in 852 BC with the conclusion of Ahaziah's reign. The year 931 BC marks the most significant date when Solomon's kingdom split into the northern nation of Israel and the southern kingdom of Judah after his death.

Second Kings picks up at 852 BC and traces the account through the falls of Samaria (722 BC) and Jerusalem (586 BC) to after the release of Jehoiachin in Babylon in 560 BC—a sum of over 293 years.

- B. **Recipients:** The Book of Kings was written to the remaining kingdom of Judah before (1 Kings 1–2 Kings 23) and after (2 Kings 24–25) its own exile in Babylon.
- C. **Occasion:** Jeremiah's prophecy and Lamentations record his eyewitness account of Babylon's siege and destruction of Jerusalem for the nation's sins. In addition to his own prophetic word, the Holy Spirit moved him to record an *historical* compilation that provides the context and justification for God's judgments upon these two nations. The leaders and the people sinned through ungodliness and idolatry, and, true to the curses of Deuteronomy 28, God gave the people the consequences of their disobedience. Therefore, the purpose of the record is to demonstrate how the welfare of Israel and Judah depended upon the faithfulness of the king and people to the covenant of Moses to teach the exiles to learn from the past mistakes of their ancestors. In large part this purpose was accomplished in history as Israel has not since the Captivity had a problem with idolatry.

**IV. Characteristics**

- A. The Books of Kings record more national leaders than any book in Scripture.
- B. Kings and Chronicles overlap in their records of the kingdom era, but have some notable differences in emphasis (Constable, *BKC*, 1:484; Merrill, *BKC*, 1:591; Zuck, *BTOT*, 162):

	<b>Kings</b>	<b>Chronicles</b>
Kings of...	Israel and Judah	Judah (almost exclusively)
Elements	Royal/prophetic	Priestly (temple and worship)
Evaluation	Based on Mosaic Law	Based on David/worship of Yahweh
Purpose	Ethical: Judging both nations	Covenant: Blessing Judah due to David
Author	Jeremiah the prophet/priest	Ezra the priest
Faith	Man's faithlessness	God's faithfulness
Outlook	Negative: rebellion/tragedy	Positive: hope amidst apostasy/tragedy
Recipients	Exilic Jews (ca. 550 BC)	Postexilic Jews (ca. 440 BC)
Chronology	971-586 BC	1011-538 BC
Emphasis	Political: emphasizes the throne	Spiritual: emphasizes the temple
Content	Historical	Theological
Attributes	God's justice	God's grace
Protagonist	Human responsibility	Divine sovereignty

Memory Acronym: KEEP A FORCE CAP (using the first letters of each category above)

- C. Reconciling the chronology of the kings in the Books of Kings and Chronicles perplexed scholars for centuries until the work of Seventh-day Adventist scholar Edwin R. Thiele (pronounced Tee-lee) in the 20th century. His books, *A Chronology of the Hebrew Kings* (Grand Rapids: Zondervan, 1977) and especially *The Mysterious Numbers of the Hebrew Kings* (rev. ed.; Chicago: Univ. of Chicago Press, 1983), have insightfully answered several chronological difficulties, particularly of Judah (Constable, *BKC*, 1:484). Thiele notes that differences in dating can be attributed to various factors (cf. OTS, 231-32):
  1. Co-regencies and vice-regencies often answer how chronologies overlap.
  2. Judah and Israel used two different methods to determine when a king's reign began, and both nations changed these methods at least once!
  3. Judah and Israel used different calendars, beginning their years at different times!
  4. The names of kings can often be confusing:
    - a. Some kings had the same name (two kings had the names Jeroboam, Jehoram, Jehoahaz, Ahaziah, etc.). Once two kings with the same name even reigned simultaneously (Jehorams of both Israel and Judah)!



- b. Two different names sometimes referred to the same king (e.g., Uzziah = Azariah, Abijah = Abijam, Joram = Jehoram, Joash = Jehoash).
- c. Also, 24 of the 39 kings had names beginning with "A" or "J."

Therefore, the chronologies are very difficult to harmonize exactly; however, in most cases the various systems differ by only one or two years.

- D. One difficult verse is 1 Kings 4:21, which states, "And Solomon ruled over all the kingdoms from the River to the land of the Philistines, as far as the border of Egypt. These countries brought tribute and were Solomon's subjects all his life." Is this the fulfillment of the promise to Abraham in Genesis 15:18 that his descendants would possess the land from the Wadi of Egypt to the Euphrates River (modern Iraq)? The following reasons indicate that this was only a partial fulfillment of this promise so that a future, full fulfillment yet awaits us:
  1. God clarified this promise to Abraham in Ezekiel by saying that this covenant with Jerusalem is an *eternal* covenant (Gen. 17:8; cf. Ezek. 16:1, 60).
  2. Solomon only collected tribute from these areas, which is different than saying that Israel *possessed* this land and lived in it ("I will give this land," Gen. 15:18).
  3. The time of fulfillment is *after exile and national repentance* (Deut. 30:2, 6, 8, 10; Jer. 17:24-27; 18:7-10) which would take place *after* the return from Babylon (Zech. 10:9-10), which was long after Solomon's time. This will not occur until the Second Coming of Christ (Rom. 11:26-27).

## Argument

The Book of 1 Kings records the first part of the history of the kings of Israel and Judah but does so with a purpose. The author's motive seems to be an ethical one—to convince his readers from the lessons of the past that God blesses obedience to His covenant but judges disobedience. This is observable in the greater part of the reign of Solomon (chs. 1—11), who prospers as he obeys (chs. 1—8) but loses the kingdom after his sins of materialism, intermarriage, and idol worship (chs. 9—11). After the kingdom divides, instability characterizes both the north and the south in relation to the obedience of the respective kings (chs. 12—22). The book also shows God's commitment to the Davidic Covenant through Solomon and the kings of Judah who constitute only one dynasty in contrast to the four dynasties of the northern kingdom which do not possess the promise of the Davidic Covenant.

## Synthesis

**Early divided kingdom covenant disobedience      Division of the Kingdom**

<b>1—11</b>	<b>Solomon's prosperity from obedience</b>
1—2	Establishment
1	Anointed king
2	Purges opposition
3—8	Rise: obedience
3	Wisdom
4	Administration
5—8	Temple
9—11	Decline: disobedience
9:1-9	Davidic Covenant reaffirmed
9:10—11:8	Disobedience
11:9-43	Judgment: Opposition & Rehoboam

**12—22**

	<b>Early divided kingdom</b>	<b><u>Key to Morality of Kings</u></b>
12—14	Jeroboam/Rehoboam	I = Israel (all bad kings)
12:1-24	Division over work	J = Judah (good kings in <b>bold</b> )
12:25—14:20	Jeroboam (I; I)—idolatry	(1) = Israel dynasties
14:21-31	Rehoboam (J)—idolatry	
15:1-8	Abijam (Abijah; J)	
<b>15:9-24</b>	<b>Asa (J)</b>	
15:25-26	Nadab (I)	
15:27—16:7	Baasha (2; I)	
16:8-14	Elah (I)	
16:15-20	Zimri (3; I)	
16:21-28	Omri (4; I)	
16:29—22:40	Ahab (I) vs. Elijah/Micaiah	
16:29-34	Idolatry/Baal worship	
17—19	Judgment (YHWH is God!)	
17	Drought vs. ravens/widow	
18	Mt. Carmel	
19	Murder thwarted vs. God's protection	
20	Victory over Syria	
21	Naboth	
22:1-40	Death at Ramoth-Gilead	
<b>22:41-50</b>	<b>Jehoshaphat (J)</b>	
22:51-53	Ahaziah (I)	

## Outline

### Summary Statement for the Book

**Solomon's prosperity from loyalty to the Law ends in disobedience which causes the division of the kingdom with mostly evil kings in Israel and Judah to remind Judah of God's loyalty to the Davidic Covenant and its own need to obey the Law.**

- I. (Chs. 1—11) The prosperity of Solomon's united kingdom due to his loyalty to the Mosaic Covenant ends in disobedience to remind Judah of God's loyalty to the Davidic Covenant and its own need to obey the Law (971-931 BC).**
- A. (Chs. 1—2) The **establishment** of Solomon as king occurs in his anointing and purging of the kingdom from rivals as evidence of God's loyalty to the Davidic Covenant.
1. (Ch. 1) Solomon is anointed king in response to his brother Adonijah's plot to seize the kingship to implement God's transfer of the Davidic Covenant from David to Solomon.
  2. (Ch. 2) Solomon purges opposition to the throne in obedience to David's charge before his death to establish the kingdom in his hands.
    - a. (2:1-12) David charges Solomon to obey the Law and execute rivals to his throne, then he dies.
    - b. (2:13-46) Solomon purges the kingdom of four competitors who would seek to take the kingdom in order to establish the kingdom in his hands.
      - 1) (2:13-25) Adonijah is executed for seeking to steal the kingdom through marriage to David's attendant Abishag.
      - 2) (2:26-27) Abiathar's priesthood transfers to Zadok in fulfillment of the LORD's prophecy that Eli's line of priests would be cut off to demonstrate God's faithfulness to His word (cf. 1 Sam. 2:30-35).
      - 3) (2:28-35) Joab is executed for conspiring with Adonijah and killing Abner and Amasa (cf. 2 Sam. 3:22-30; 20:8-10).

- 4) (2:36-46) Shimei is executed for disobeying Solomon's exile imposed upon him and for cursing David.

B. (Chs. 3—8) The **rise** of Solomon as king demonstrates God's blessing upon him as the legitimate heir to the promises of the Davidic Covenant to instruct Israel in the benefits of following the Law.

1. (Ch. 3) Solomon's personal wisdom is granted him from the LORD for his obedience to the Law and demonstrated in his judgment between two prostitutes to show God's blessing upon him as the legitimate heir to the promises of the Davidic Covenant.
2. (Ch. 4) Solomon's political administration through chief officials, governors, and officers receives international acclaim because of his breadth of wisdom to instruct Israel in the benefits of following the Law.
3. (Chs. 5—8) Solomon's temple is constructed, dedicated, and filled with the glory of God, affirming God's blessing on his life of obedience.
  - a. (Chs. 5—6) Construction of the temple takes seven years and employs thousands of Hiram's men and 213,000 Israelite workmen!
  - b. (7:1-12) In contrast, construction of Solomon's much larger palace takes 13 years!

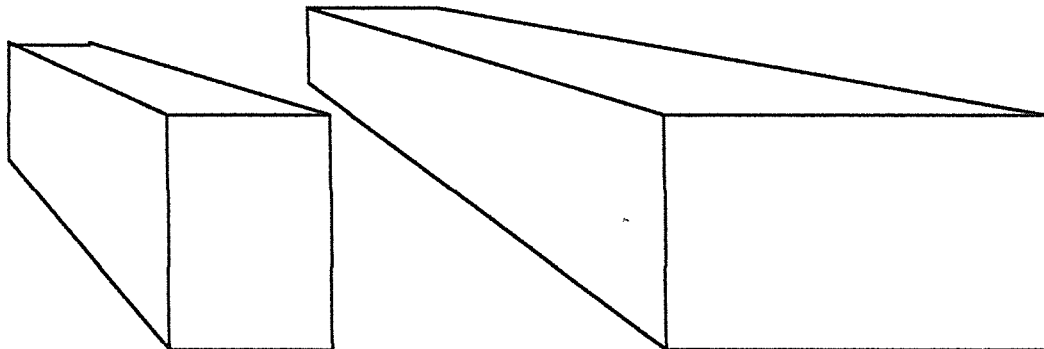

Solomon's Building	Temple (1 Kings 6:1-2)	Palace (1 Kings 7:1-2)
Height	30 cubits (13.5 meters)	30 cubits (13.5 meters)
Width	20 cubits (9 meters)	50 cubits (23 meters)
Length	60 cubits (27 meters)	100 cubits (46 meters)
Construction	966-959 BC (7 years; 1 Kings 6:38)	959-946 BC (13 years; cf. Hag. 1:2-4)
Location	Rock of Moriah: place where Abraham offered Isaac (Gen. 22:14), later the threshing floor of Araunah (2 Sam. 24:16), and later the temple (1 Chron. 22:1; 2 Chron. 3:1)	Just south of the temple, which was next to the palace of Pharaoh's daughter, wife of Solomon (2 Chron. 8:11)

- c. (7:13-51) Temple furnishings are built and brought into the temple.
- d. (Ch. 8) After the return of the ark and *Shekinah* glory, Solomon dedicates the temple with a message and prayer which meets both God's and the people's approval.

C. (Chs. 9—11) The **decline** of Solomon as king stems from his disobedience to God's command to follow the Mosaic Covenant and is met with opposition and the passing on of only one tribe of his entire kingdom to a godless son.

1. (9:1-9) The LORD reaffirms the Davidic Covenant to Solomon at the height of his life with a stern warning not to forsake the Mosaic Covenant.
2. (9:10—11:8) Although possessing great wisdom and splendor, Solomon disobeys the Mosaic Covenant despite God's warning.
  - a. (9:10-14) He seeks to pay Hiram with twenty cities in the Promised Land contrary to the Law (cf. Joshua 1:3-4).
  - b. (9:15-28) He enslaves Canaanites rather than exterminating them (cf. Exod. 23:31-33).
  - c. (10:1-25) He multiplies wealth contrary to the Law (cf. Deut. 17:17b).
  - d. (10:26-29) He multiplies horses contrary to the Law (cf. Deut. 17:16).
  - e. (11:1-2) He intermarries with foreigners contrary to the Law (cf. Exod. 34:15-16).
  - f. (11:3) He multiplies wives contrary to the Law (cf. Deut. 17:17a).
  - g. (11:4-8) He worships pagan gods and builds altars to them contrary to the Law (cf. Exod. 34:15-16).
3. (11:9-43) Solomon is chastened for his disobedience to the Mosaic Covenant by opposition and succession of his godless son Rehoboam who would rule only one tribe.
  - a. (11:9-13) The LORD promises to judge Solomon's disobedience by having his heir rule only the tribe of Judah in a divided rather than a united kingdom.
  - b. (11:14-40) God raises up both external and internal opposition to Solomon because of his disobedience to the Mosaic Covenant.
    - 1) (11:14-25) External opposition comes from Hadad the Edomite and Rezon the Zobahite, both unconquered enemies of David.
    - 2) (11:26-40) Internal opposition comes from God's promise to Jeroboam, one of Solomon's own officials, that He would give him the northern nation of ten tribes.
  - c. (11:41-43) At Solomon's death after a forty year rule his throne is turned over to his godless son Rehoboam who would rule only one tribe.

The Kingdom in Tranquillity	Chapter 12 Split of the Kingdom	The Kingdoms in Turmoil
<b>God rules His people through a king: SOLOMON</b>		<b>God speaks to His people through a prophet: ELIJAH</b>

### The Significance of 1 Kings 12

Irving L. Jensen, *Jensen's Survey of the OT*, 196

- II. (Chs. 12—22) The instability of the divided kingdom under the early kings of Israel and Judah due to their wavering loyalty to the Law is conveyed to remind Israel to obey the Law—not repeat the past (931-852 BC).**
- A. (Chs. 12—14) The kingdom divides under the evil reigns of Jeroboam and Rehoboam as a picture of the disaster which results from idolatry to remind Israel to obey the Law rather than repeat the sins of the past.
    1. (12:1-24) The division of the kingdom because of Rehoboam's commitment to overwork the people teaches that God blesses righteous leadership but punishes evil.

2. (12:25—14:20) Jeroboam's evil reign is judged for his promotion of idolatry in the northern kingdom as an illustration of the faithfulness of the word of God and His commitment to the Davidic Covenant (first of nine dynasties in Israel).
    - a. (12:25-33) Jeroboam protects his evil grasp upon the northern tribes by constructing alternate pagan altars at Bethel and Dan to keep his people from worship at Jerusalem.
    - b. (Ch. 13) God sends a prophet to warn Jeroboam of his evil ways who himself becomes an example of the perils of disobedience, yet Jeroboam persists in idolatry.
    - c. (14:1-20) Ahijah's prophecy to Jeroboam's wife of the death of her son and thus the end of the dynasty comes true as an illustration of the faithfulness of the word of God and His commitment to the Davidic Covenant sustained in Judah.
  3. (14:21-31) Rehoboam's evil reign of idolatry is judged by Shishak of Egypt's theft of Solomon's gold temple shields to teach the cost of disobeying the covenant (first and only dynasty in Judah).
- B. (15:1-24) The mixed reigns of two kings in Judah sees continued idolatry followed by its removal from the land.
1. (15:1-8) Abijam (Abijah) repeats the same idolatrous practices committed by his father Rehoboam.
  2. (15:9-24) Asa's good reign purges all idolatry except the high places and therefore brings some reform to the nation.
- C. (15:25—16:28) The evil reigns of five kings in Israel each are judged for disobedience to the Mosaic Covenant.
1. (15:25-26) Nadab commits evil and is judged by the loss of his dynasty.
  2. (15:27—16:7) Baasha (Second Dynasty) commits evil despite warnings from the prophet Jehu.
  3. (16:8-14) Elah commits evil and is judged by the loss of his dynasty.
  4. (16:15-20) Zimri (Third Dynasty) reigns only seven days as he quickly commits suicide when others retaliate against his murder of Baasha's entire family and is therefore judged by the loss of his dynasty.
  5. (16:21-28) Omri (Fourth Dynasty) builds the city of Samaria but is judged for sinning worse than any previous king—especially for enticing Israel to idol worship.
- D. (16:29—22:40) The wicked Ahab of Israel is confronted with the prophets Elijah and Micaiah in demonstration of the LORD's sovereignty over Baal.
1. (16:29-34) Ahab not only encourages idolatry but through his marriage to the Sidonian princess Jezebel introduces Baal worship in Israel.
  2. (Chs. 17—19) God judges Ahab and Jezebel for their sin but protects Elijah from harm to teach that Yahweh—not Baal—is God.
    - a. (Ch. 17) Ahab receives word from Elijah of a three and a half year drought but Elijah is provided for miraculously by ravens and a widow to demonstrate that Yahweh is God, not Baal.
    - b. (Ch. 18) Ahab and Jezebel are humiliated on Mount Carmel by Elijah's demonstration of the power of God and murder of Baal's prophets which show that Yahweh, not Baal, deserves worship.

- c. (Ch. 19) Jezebel's efforts to kill Elijah fail while God encourages Elijah with food, a personal appearance, and provision of Elisha—a new disciple—to show that while Yahweh protects Elijah, Baal is silent.
- 3. (Ch. 20) Ahab defeats Syria at the battles of Samaria and Aphek but is prophesied death because he trusts Ben-Hadad and spares his life in violation of God's command rather than trusting the Lord above false gods (20:23-25, 28).
- 4. (Ch. 21) The result of Ahab's murder of Naboth and seizure of his vineyard inheritance is God's announcement that his family line would be cut off after his son's rule.
  - a. (21:1-16) The manner in which Ahab abuses his authority as king is to allow Jezebel to seize Naboth's vineyard and kill him.
  - b. (21:17-29) The result of Ahab's abuse of his authority is God's announcement that his family line would be cut off after his son rules.
- 5. (22:1-40) God brings final judgment upon Ahab through his death at Ramoth-Gilead in fulfillment of the prophecies of Micaiah and Elijah due to his greater trust in the powerless prophets of Baal rather than the true prophet of the Lord.
- E. (22:41-50) Jehoshaphat's good reign in Judah purges the male shrine prostitutes and lacks only removal of the high places.
- F. (22:51-53) The beginning of Ahaziah's evil reign in Israel continues the Baal worship begun by his father Ahab (the rest of his reign is completed in 2 Kings 1).

Note: For a helpful guide in correlating the various accounts in the lives of the kings of Israel and Judah, consult the following harmony. It generally places the narratives chronologically in parallel columns but is strongest in its literary comparisons (see a page of Newsome on p. 267b).

Newsome, James D., Jr. *A Synoptic Harmony of Samuel, Kings, and Chronicles: With Related Passages from Psalms, Isaiah, Jeremiah, and Ezra*. Grand Rapids: Baker, 1986. 275 pp.

## QUIZ TIME

Fill in the names of one prophet and the rest kings in 1 Kings

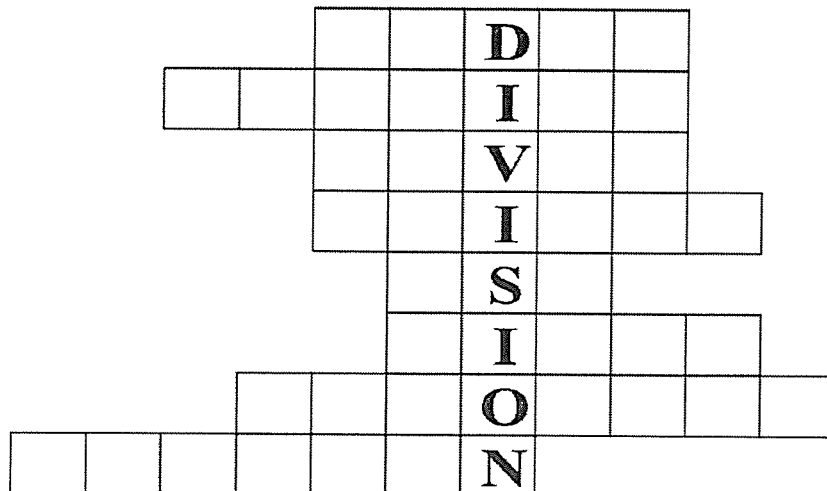

## THE DIVIDED KINGDOMS

### North

Israel

10 tribes

9 dynasties

19 Kings

First - Jeroboam

Last - Hoshea

12 murdered/killed

0 good kings

Exiled in 722 B.C.

Exiled to Assyria

### South

Judah

2 tribes

1 dynasty

19 Kings & 1 queen

First - Rehoboam

Last - Zedekiah

7 murdered/killed

8 good kings

Exiled in 586 B.C.

Exiled to Babylon

# Solomon's Temple and Furnishings

*The Bible Visual Resource Book, 68*

1 Kings

## Solomon's Temple

960-586 B.C.  
1 Kings 6

Temple source materials are subject to academic interpretation, and subsequent art reconstructions vary.

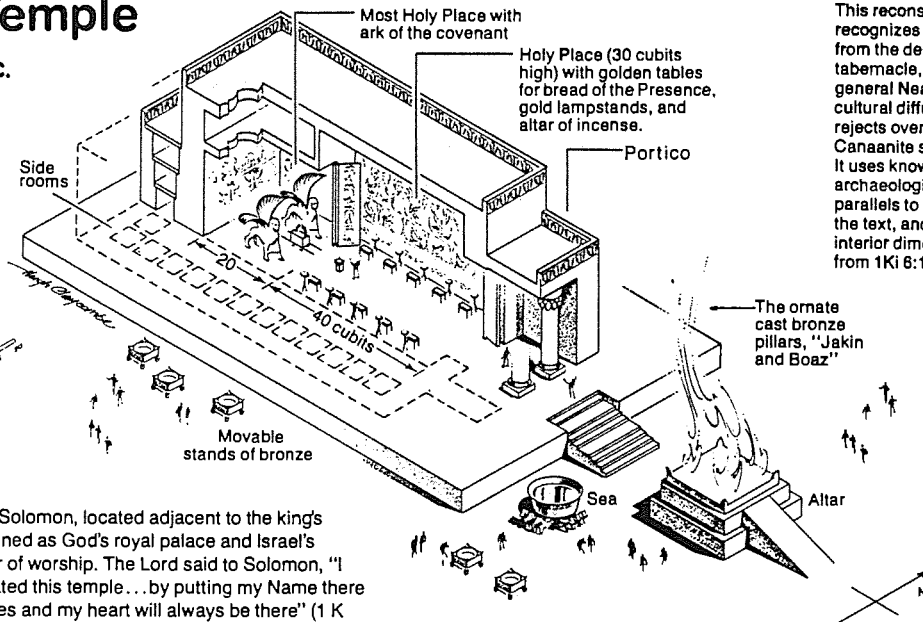
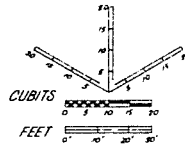

This reconstruction recognizes influence from the desert tabernacle, accepts general Near Eastern cultural diffusion, and rejects overt pagan Canaanite symbols. It uses known archaeological parallels to supplement the text, and assumes interior dimensions from 1Ki 6:17-20.

The temple of Solomon, located adjacent to the king's palace, functioned as God's royal palace and Israel's national center of worship. The Lord said to Solomon, "I have consecrated this temple... by putting my Name there forever. My eyes and my heart will always be there" (1 K 9:3). By its cosmological and royal symbolism, the sanctuary taught the absolute sovereignty of the Lord over the whole creation and his special headship over Israel.

The floor plan is a type that has a long history in Semitic religion, particularly among the West Semites. An early example of the tripartite division into *'ulam, hekal, and debir* (portico, main hall, and inner sanctuary) has been found at Syrian Ebla (c. 2300 B.C.) and, much later but more contemporaneous with Solomon, at Tell Tainat in the Orontes basin (c. 900 B.C.). Like Solomon's, the

later temple has three divisions, contains two columns supporting the entrance, and is located adjacent to the royal palace.

Many archaeological parallels can be drawn to the methods of construction used in the temple, e.g., the "stone and cedar beam" technique described in 1Ki 6:36. Interestingly, evidence for the largest bronze-casting industry ever found in Palestine comes from the same locale and period as that indicated in Scripture: Zarethan in the Jordan Valley c. 1000 B.C.

© Hugh Claycombe 1986

## Temple Furnishings

Glimpses of the rich ornamentation of Solomon's temple can be gained through recent discoveries that illumine the text of 1 Ki 6-7.

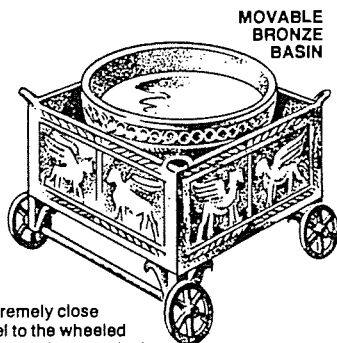

An extremely close parallel to the wheeled portable basins used in the courtyard of the temple has come from archaeological excavations on Cyprus. This representation combines elements from the Biblical text with the archaeological evidence.

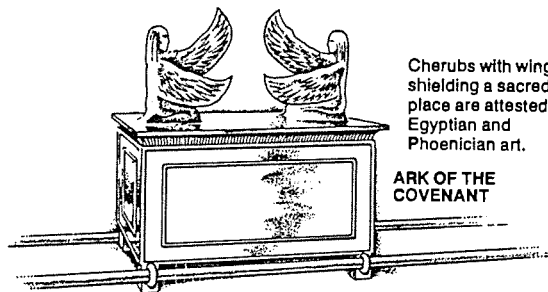

Cherubs with wings shielding a sacred place are attested in Egyptian and Phoenician art.

ARK OF THE COVENANT

1 Kings 7:13-15

Ten lampstands were in the temple, five on each side of the sanctuary (1 Ki 7:49), to which were added ten tables (2 Ch 4:8). Ritual sevenfold lamps have been found at several places in Palestine, including Hazor and Dothan. The stand itself is modeled on bronze ones from the excavations at Megiddo.

LAMPSTAND

TABLE FOR THE BREAD OF THE PRESENCE

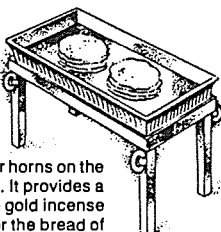

A stone incense altar having four horns on the corners was found at Megiddo. It provides a clear idea of the shape of the gold incense altar in the temple. The table for the bread of the Presence was also made of gold.

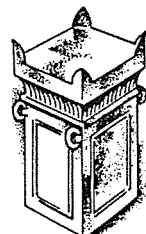

INCENSE ALTAR

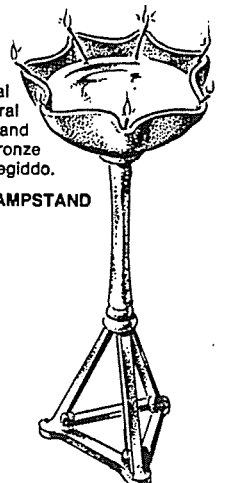



# Possible Locations of Solomon's Temple THE TEMPLE MOUNT

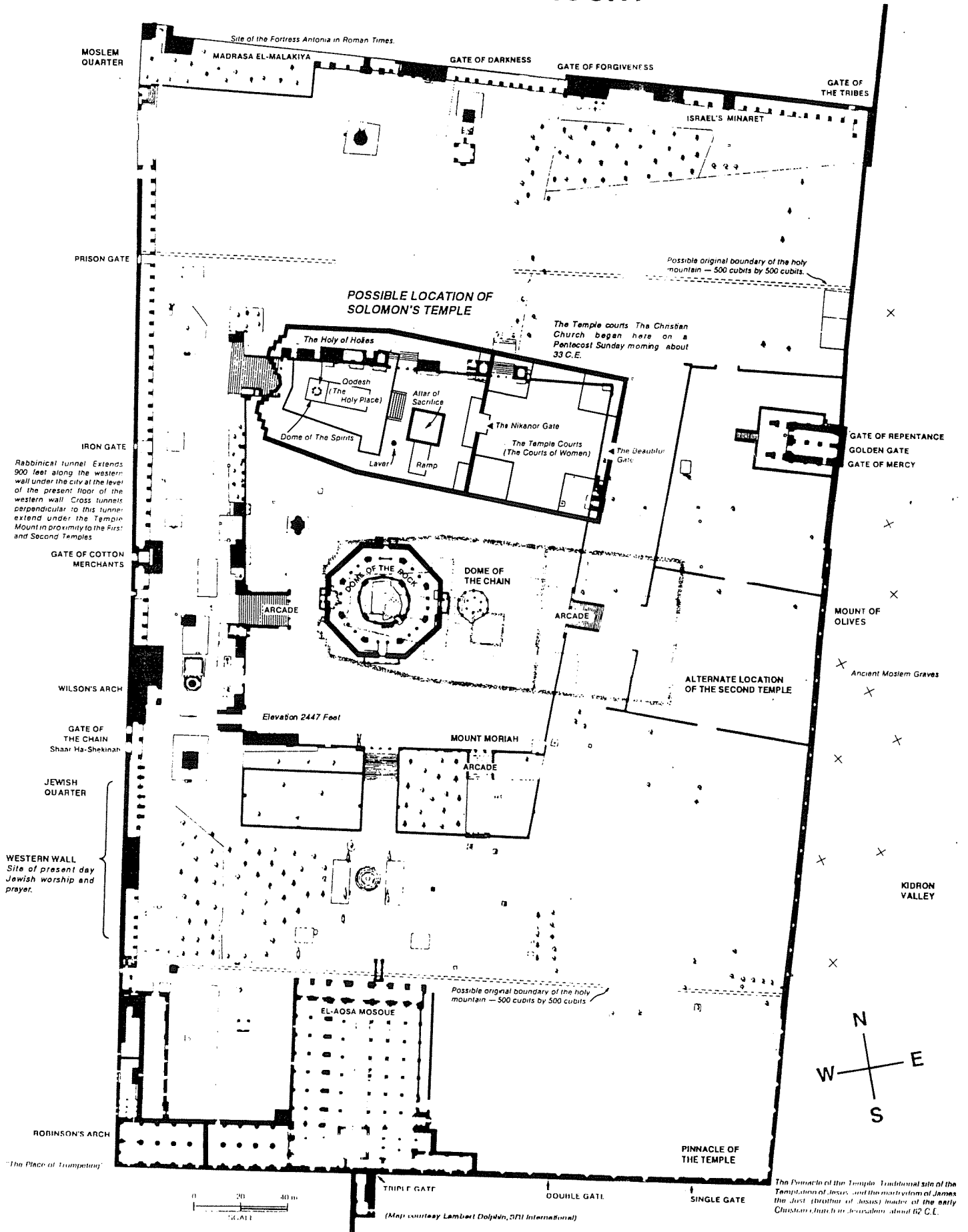

# Geography of the Divided Kingdom

*The Bible Visual Resource Book, 75*

1 Kings

## The Divided Kingdom

930-586 B.C.

The division of Solomon's kingdom had geographical and political causes, with roots reaching back to earlier tribal rivalries. Israel was closer to Phoenician cities and major trade routes than Judah, whose heartland was a plateau-like ridge higher than the district around Samaria.

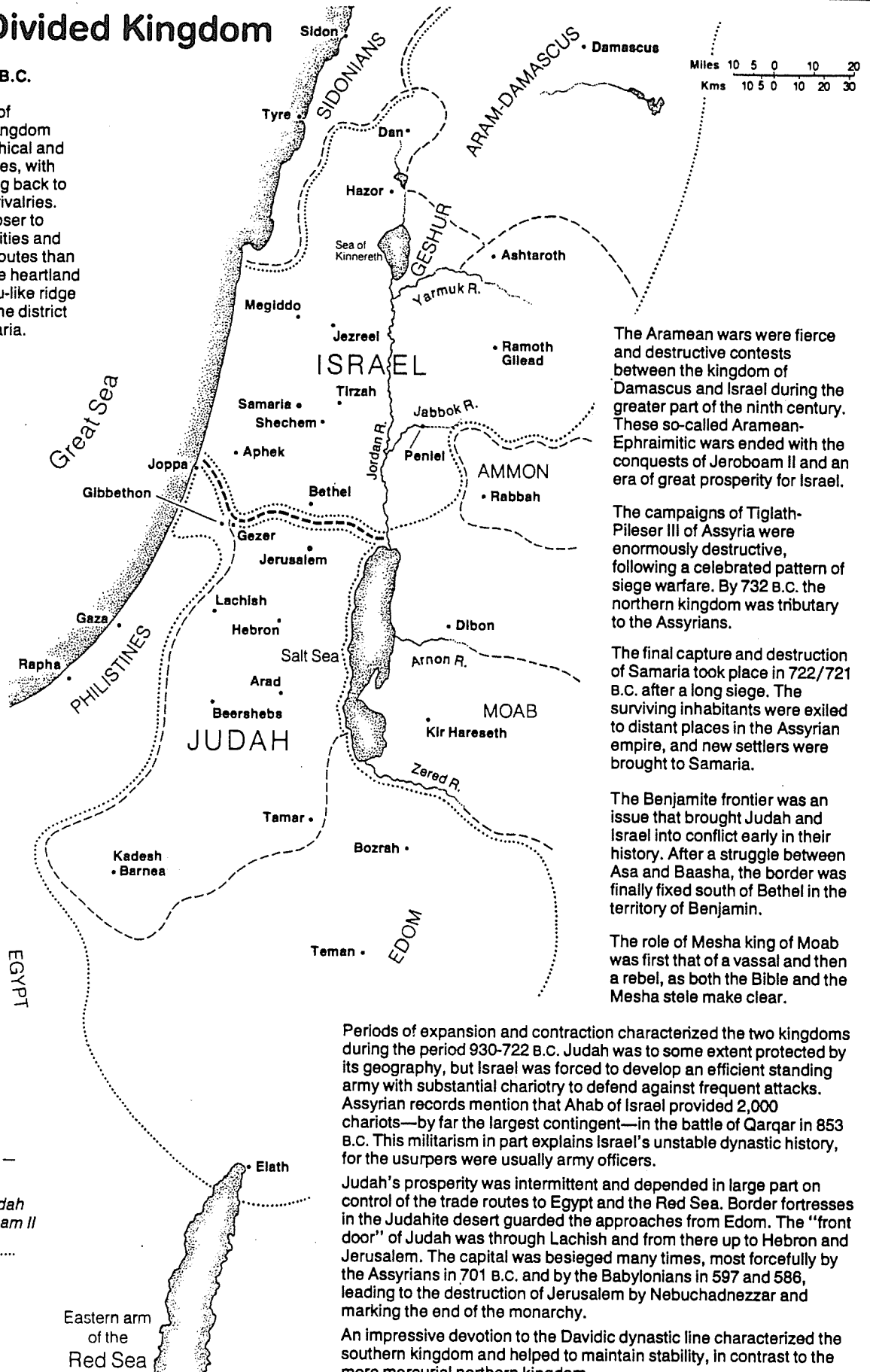

The Aramean wars were fierce and destructive contests between the kingdom of Damascus and Israel during the greater part of the ninth century. These so-called Aramean-Ephraimitic wars ended with the conquests of Jeroboam II and an era of great prosperity for Israel.

The campaigns of Tiglath-Pileser III of Assyria were enormously destructive, following a celebrated pattern of siege warfare. By 732 B.C. the northern kingdom was tributary to the Assyrians.

The final capture and destruction of Samaria took place in 722/721 B.C. after a long siege. The surviving inhabitants were exiled to distant places in the Assyrian empire, and new settlers were brought to Samaria.

The Benjamite frontier was an issue that brought Judah and Israel into conflict early in their history. After a struggle between Asa and Baasha, the border was finally fixed south of Bethel in the territory of Benjamin.

The role of Mesha king of Moab was first that of a vassal and then a rebel, as both the Bible and the Mesha stele make clear.

Periods of expansion and contraction characterized the two kingdoms during the period 930-722 B.C. Judah was to some extent protected by its geography, but Israel was forced to develop an efficient standing army with substantial chariotry to defend against frequent attacks. Assyrian records mention that Ahab of Israel provided 2,000 chariots—by far the largest contingent—in the battle of Qarqar in 853 B.C. This militarism in part explains Israel's unstable dynastic history, for the usurpers were usually army officers.

Judah's prosperity was intermittent and depended in large part on control of the trade routes to Egypt and the Red Sea. Border fortresses in the Judahite desert guarded the approaches from Edom. The "front door" of Judah was through Lachish and from there up to Hebron and Jerusalem. The capital was besieged many times, most forcefully by the Assyrians in 701 B.C. and by the Babylonians in 597 and 586, leading to the destruction of Jerusalem by Nebuchadnezzar and marking the end of the monarchy.

An impressive devotion to the Davidic dynastic line characterized the southern kingdom and helped to maintain stability, in contrast to the more mercurial northern kingdom.

Original borders  
c. 930 B.C.

Borders of Israel and Judah under Jeroboam II and Uzziah

Eastern arm of the Red Sea

## STUDY-GRAPH

Fourth Revised Edition

© 1962, 1968 by  
JOHN C. WHITCOMB, JR.

## Chart of Old Testament Kings and Prophets

Published by  
BMH BOOKSP. O. Box 544  
Winona Lake, IN 46590JOHN C. WHITCOMB, Th.D.  
Professor of Theology and Old Testament  
Grace Theological Seminary  
Winona Lake, Indiana

## INTRODUCTION

The chronological problems connected with the period of the Divided Monarchy in the Old Testament have defied solution for well over 2,000 years. Recently, however, Edwin R. Thiele's book *The Mysterious Numbers of the Hebrew Kings* (2d ed.; Grand Rapids: Eerdmans, 1965) has gained international recognition for its remarkable harmonization of the biblical and extrabiblical chronological data which are available for this important period of ancient Near Eastern history. Some of the more important features of Dr. Thiele's system are as follows:

(1) From the time of the division of the kingdom after the death of Solomon, the official scribes of the southern kingdom of Judah counted the regnal years of their kings from the month *Tishri* (September-October), while the scribes of the northern kingdom of Israel reckoned the regnal years of their kings from the month *Nisan* (March-April). Proof that *Tishri* reckoning was employed in Judah may be found by comparing II Kings 22:3 with 23:23, where the discovery of the law by Hilkiah and the subsequent Passover in Nisan, which must have occurred several months later, are both dated in the 18th year of Josiah. Although no scriptural evidence is available for the time of the beginning of the regnal year in the northern kingdom of Israel, Thiele demonstrates that "when a Nisan-to-Nisan regnal year is used for Israel together with a *Tishri*-to-*Tishri* year for Judah, the perplexing discrepancies disappear and a harmonious chronological pattern results" (p. 30).

(2) The scribes of Israel used the Egyptian *nonaccession-year*, (postdating) system in reckoning the reigns of their kings from the division of the kingdom down to 798 B.C., and the Babylonian *accession-year* (antedating) system from that year onward. According to the *nonaccession-year* system, that portion of a year which followed a king's accession to the throne and which preceded the official New Year (whether *Tishri* 1 or *Nisan* 1) was counted as his first official year. But according to the *accession-year* system, that initial period was called his accession year, and not until after the New Year did his first official year begin. Proof that Israel followed the *nonaccession-year* system during the 9th century B.C. may be found in the fact that Jehu (according to Assyrian records) paid tribute to Shalmaneser III only 12 years after Ahab fought in the Battle of Qarqar, while the scribes of Israel attributed 14 years to the reigns of the two intervening kings, Ahaziah and Joram. On the other hand, the scribes of Judah must have employed the *accession-year* system for their kings, except during that dark period of their history when the influence of the northern kingdom, through Queen Athaliah, was predominant (848-796 B.C.); for only by means of this assumption is it possible to harmonize the synchronisms employed by the northern and southern scribes.

(3) When the scribes of one kingdom synchronized the reign of their king with the reign of the neighboring king, they employed their own system of reckoning for both kings instead of employing the foreign system for the foreign king.

(4) Many of the kings of Judah (and also Jehoash of Israel) associated their sons with them on their thrones during the final years of their reigns, thus necessitating the allowance of considerable overlappings, or *coregencies*.

(5) The entire system of Old Testament chronology for the kings of Israel and Judah can be interlocked at vital points with the astronomically verified absolute chronology of the Assyrian eponym lists and thus with

the other important chronological systems of the ancient Near East. Some of the major points of contact between the biblical and the Assyrian records are the Battle of Qarqar (853), the tribute of Jehu (841), the first western campaign of Tiglathpileser III (743), the conquest of Samaria (722), and Sennacherib's attack on Jerusalem (701). In addition to these synchronisms with Assyrian records, we have Pharaoh Shishak's invasion of Judah in 925 B.C., the conquest of Judah by Nebuchadnezzar in 605 B.C., and Nebuchadnezzar's deportation of Jehoiachin in 597 B.C.

Through a careful application of these basic chronological principles, Dr. Thiele has apparently succeeded in solving most of the problems associated with the chronology of this complex period of Old Testament history. One serious problem that still remains is the harmonizing of II Kings 17:1; 18:1, 9-10 with other chronological references. For a recent proposed solution of this problem, see Harold G. Stigers, "The Interphased Chronology of Jotham, Ahaz, Hezekiah and Hoshea," *Bulletin of the Evangelical Theological Society*, IX (Spring, 1966), 81-90.

If we adopt 931 B.C. as the date of Solomon's death and the division of the kingdom, then Solomon's 40-year reign began in 971 B.C. and David's 40-year reign began in 1011 B.C. We learn from Acts 13:21 that Saul's reign lasted 40 years; thus this may be considered as the duration of his dynasty, which ended with the death of Ishbosheth 7 years after his own death on Mt. Gilboa (cf. Hebrew text of I Sam. 13:1 with II Sam. 2:10). For the chronology of Samuel, Samson, and the earlier judges, as well as the period back to Abraham, see the companion study-graph of Old Testament Patriarchs and Judges.

The early date for the prophet Obadiah is suggested by the fact that Jeremiah (49:7-22) seems to quote from him, and not the reverse. Thus, the cruelty referred to in Obadiah 10-14 must refer to the invasion of Jerusalem in the reign of Jehoram (II Chron. 21:16-17; cf. II Kings 8:20-22). For supporting arguments, see Gleason L. Archer, Jr., *A Survey of Old Testament Introduction* (Chicago: Moody, rev., 1974, pp. 299-303). Support for the early date of the prophet Joel is given by Archer (*ibid.*, pp. 303-307) and Edward J. Young in *An Introduction to the Old Testament Grand Rapids: Eerdmans, rev. ed., 1960*, pp. 270-73. The chronology of the kings of Damascus is discussed in Merrill F. Unger's *Israel and the Aramaeans of Damascus* (London: James Clarke & Co., 1957).

The prophets Jeremiah, Ezekiel, Haggai, and Zechariah used *Nisan* (spring to spring) reckoning for Jewish as well as Babylonian and Persian kings. The only exceptions are Jeremiah 39:1-10 and 52:1-34, where *Tishri* (autumn to autumn) reckoning is employed for Jewish kings as in the book of Kings. Thus, the apparent discrepancy between Daniel 1:1 and Jeremiah 25:1 may be explained on the basis of *Tishri* as opposed to *Nisan* reckoning for the reign of King Jehoiakim (the phrase "first year of Nebuchadnezzar" in Jeremiah 25:1 should be translated "accession year of Nebuchadnezzar"—August, 605 to April, 604 B.C.). Furthermore, it becomes clear on this basis that the siege of Jerusalem lasted for two and a half years instead of one and a half years as many have thought; for on *Tishri* reckoning, it began on January 15, 588, and ended on July 18, 586 B.C. This is confirmed by the fact that Ezekiel 24:1 must be dated in January, 588 B.C., to be in Zedekiah's 9th year, while Ezekiel 33:21 (which is obviously just three years after this and about six months after the fall of Jerusalem) must be in January, 585 B.C.

While Jeremiah 25:1-14 and Daniel 9:1-2 seem to indicate rather clearly that the 70-year captivity of Judah is to be reckoned from 605 B.C. to 536 B.C., it is also possible to reckon a 70-year period of desolations for Jerusalem and its temple from 586 B.C. to 516 B.C. (cf. Zech. 1:12 and 7:7). For a recent defense of the early date (6th century B.C.) and historicity of the book of Daniel, see J. C. Whitcomb, Jr., *Darius the Mede: A Study in Historical Identification* (Nutley, N. J.: Presbyterian and Reformed, 1963), pp. 1-3, 50-63.

That Nehemiah employed *Tishri* reckoning even for Persian kings is evidenced by the fact that he puts the month *Kislev* (9th month) and the subsequent month *Nisan* (1st month) both in the 20th year of Artaxerxes (cf. Neh. 1:1 and 2:1). Ezra probably used the same system, since the books of Ezra and Nehemiah were counted as a unit in the Hebrew Bible. On this basis, the first year of Cyrus (Ezra 1:1) would have lasted from the fall of 538 to the fall of 537 B.C., and the second month of the second year, when the temple foundation was laid (Ezra 3:8), would have been April-May, 536 (the months always being numbered from *Nisan*, even in *Tishri* reckoning). Now the first official year of Artaxerxes I on the basis of *Tishri* reckoning must have begun on October 19, 465 B.C., for the murder of Xerxes has been placed in the month of August, 465 B.C., by Richard A. Parker and Waldo H. Dubberstein in their definitive work, *Babylonian Chronology 626 B.C.-A.D. 75* (Providence, R. I.: Brown University, 1956), p. 17. Therefore, Ezra's expedition must have left Babylon for Jerusalem on April 8, 458 B.C., arriving there on August 24 (cf. Ezra 7:8-9); Nehemiah must have received permission to rebuild the walls of Jerusalem in April or May, 445 B.C. (cf. Neh. 2:1-8); and his return to Babylon, after twelve years in Jerusalem (Neh. 13:6; cf. 5:14), must have taken place between October, 434 B.C., and September, 433 B.C. After an interval of time long enough for many abuses to arise in Jerusalem (Neh. 13:4-5, 7-31), presumably in the early part of the reign of Darius II (423-404 B.C.), Nehemiah returned to Jerusalem and carried out additional reforms.

Many have insisted that the "Darius the Persian" of Nehemiah 12:22 must be Darius III Codomannus (335-331 B.C.) and that "Jaddua" mentioned in the same verse must be the high priest of that name referred to by Josephus (*Ant.*, 11:8:4) as a contemporary of Alexander the Great. On this basis, it is denied that Nehemiah could have written the book that has been traditionally attributed to him. But it is entirely possible that "Darius the Persian" was Darius II Ochus (423-404 B.C.), and that Jaddua the son of Johanan could have become high priest before the death of Darius II. In the first place, Jaddua must have been well over thirty years of age by 404 B.C., for he was only five generations removed from Joshua (Neh. 12:10-11) who was high priest in 538 B.C. (Ezra 3:2). In the second place, the Elephantine Papyri mention his father Johanan as being high priest in 408 B.C. In the third place, Josephus is far from accurate in his reconstruction of the events of this period, and even if he were accurate, the Jaddua he mentions could have been a later high priest of the same name. In the light of these considerations, we may conclude that Nehemiah lived to see Jaddua become high priest and that he could have been the author of the entire book of Nehemiah.

Order the paper edition of this chart (18" x 25") from BMH Books, Box 544, Winona Lake, IN 46590; or Dr. John C. Whitcomb, Grace Seminary, Winona Lake, IN 46590.

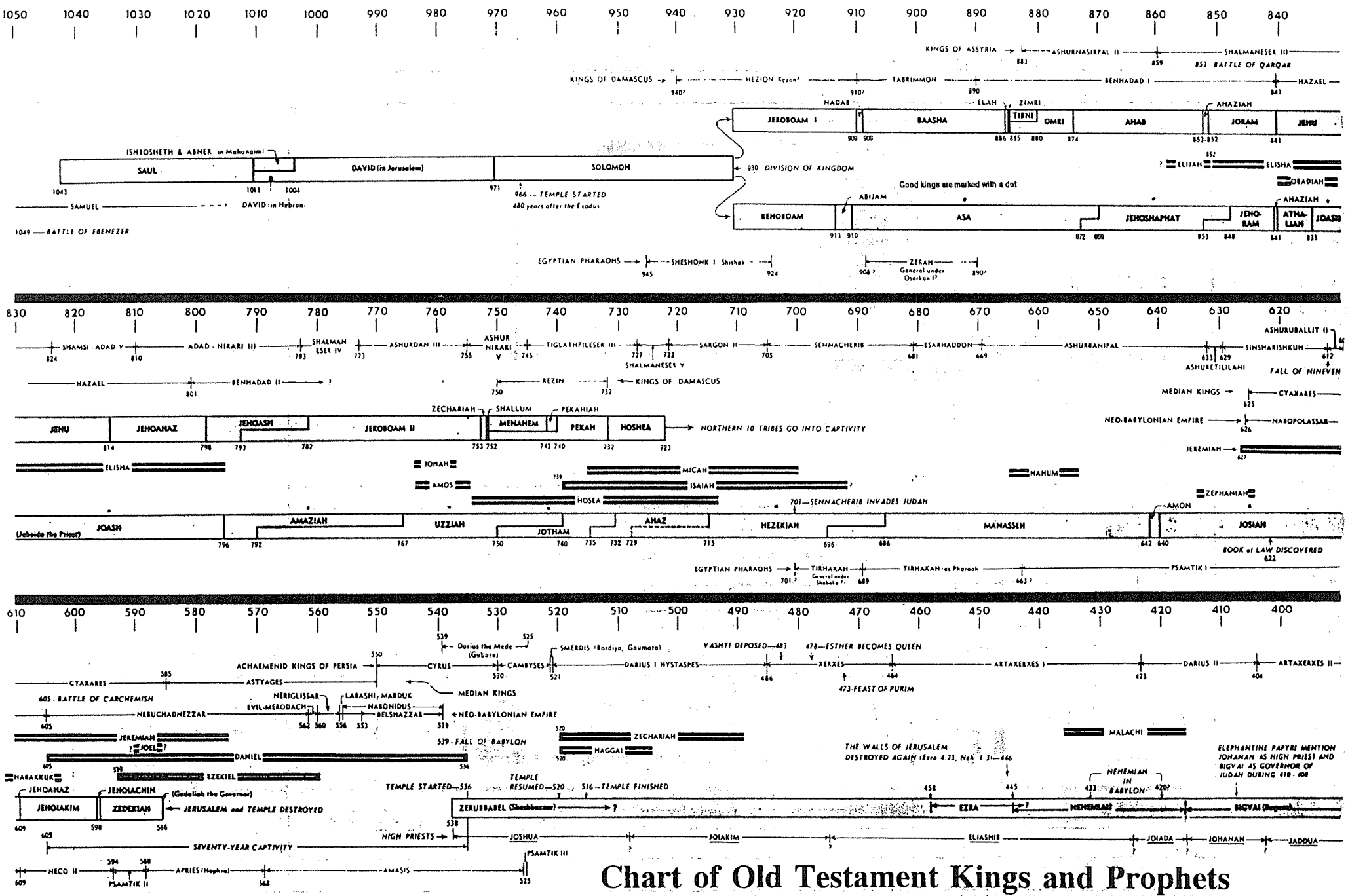

# Chart of Old Testament Kings and Prophets

Adapted from John C. Whitcomb, 4th ed. (Winona Lake, IN: BMH Books, 1962, 1968), p. 2  
 Whitcomb's 1968 chart was based on the chronology of Edwin R. Thiele, *The Mysterious Numbers of the Hebrew Kings*, 2d ed. (Grand Rapids: Zondervan, 1963) and is here updated with Thiele's 3rd ed. (Grand Rapids: Zondervan, 1983). Dates are also changed for Joel, Jonah, Nahum, and Habakkuk.

# Chart of Old Testament Kings and Prophets (Blank)

John C. Whitcomb (Outline of the Previous Page)

\_\_\_\_\_

\_\_\_\_\_

\_\_\_\_\_

\_\_\_\_\_

\_\_\_\_\_

\_\_\_\_\_

\_\_\_\_\_

\_\_\_\_\_

\_\_\_\_\_

# Chronology of Kings and Prophets

Dr. Ernie Poulson, Grace Baptist Church, Singapore (used with permission)

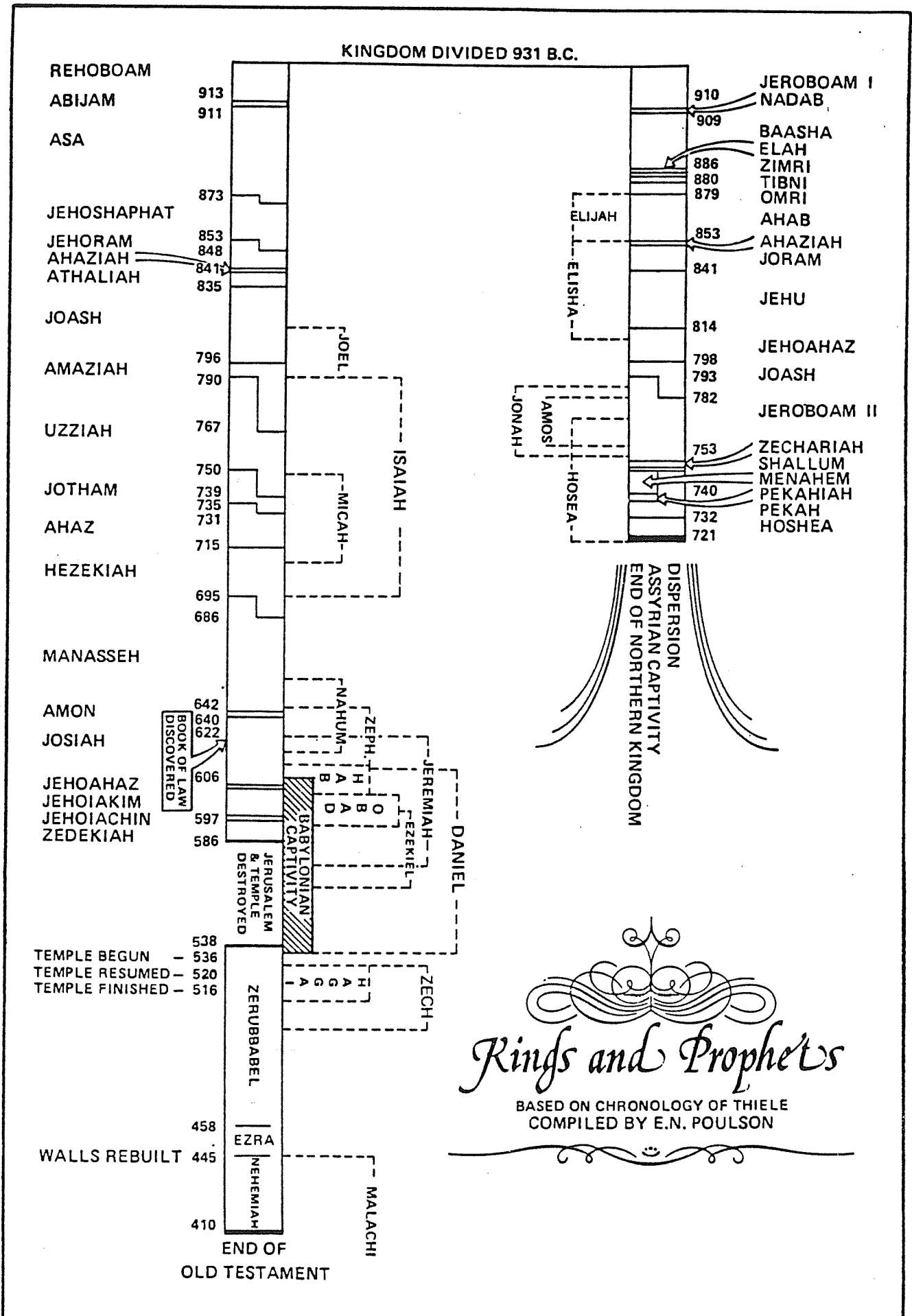

# Rulers of Israel and Judah

DATA AND DATES IN  
ORDER OF SEQUENCE

1. 1K 12:1-24 14:21-31	<i>Rehoboam (Judah)</i>	17 years		930-913				
2. 1K 12:25—14:20	<b>Jeroboam I (Israel)</b>	22 years		930-909				
3. 1K 15:1-8	<i>Abijah (Judah)</i>	18th of Jeroboam	3 years	913-910				
4. 1K 15:9-24	<i>Asa (Judah)</i>	20th of Jeroboam	41 years	910-869				
5. 1K 15:25-31	<b>Nadab (Israel)</b>	2nd of Asa	2 years	909-908				
6. 1K 15:32—16:7	<b>Baasha (Israel)</b>	3rd of Asa	24 years	908-886				
7. 1K 16:8-14	<b>Elah (Israel)</b>	26th of Asa	2 years	888-885				
8. 1K 16:15-20	<b>Zimri (Israel)</b>	27th of Asa	7 days	885				
9. 1K 16:21-22	<b>Tibni (Israel)</b>		Overlap with Omri	885-880				
10. 1K 16:23-28	<b>Omri (Israel)</b>	27th of Asa	Made king by the people	885				
			Overlap with Tibni	885-880				
		12 years	Official reign = 11 actual years	885-874				
		31st of Asa	Beginning of sole reign	880				
11. 1K 16:29—22:40	<b>Ahab (Israel)</b>	38th of Asa	22 years	Official reign = 21 actual years	874-853			
12. 1K 22:41-50	<i>Jehoshaphat (Judah)</i>		Co-regency with Asa	872-869				
		25 years	Official reign	872-848				
		4th of Ahab	Beginning of sole reign	869				
			Has Jehoram as regent	853-848				
13. 1K 22:51— 2K 1:18	<b>Ahaziah (Israel)</b>	17th of Jehoshaphat	2 years	Official reign = 1 yr. actual reign	853-852			
14. 2K 1:1-7 2K 3:1—8:15	<b>Joram (Israel)</b>	2nd of Jehoram	12 years	Official reign = 11 actual years	852-841			
15. 2K 8:16-24	<i>Jehoram (Judah)</i>	5th of Joram	8 years	Beginning of sole reign	848			
			Official reign = 7 actual years	848-841				
16. 2K 8:25-29 2K 9:29	<i>Ahaziah (Judah)</i>	12th of Joram	1 year	Nonaccession-year reckoning	841			
		11th of Joram	Accession-year reckoning	841*				
17. 2K 9:30—10:38	<b>Jehu (Israel)</b>		28 years	841-814				
18. 2K 11	<i>Athaliah (Judah)</i>		7 years	841-835				
19. 2K 12	<i>Joash (Judah)</i>	7th of Jehu	40 years	835-798				
20. 2K 13:1-9	<b>Jehoahaz (Israel)</b>	23rd of Joash	17 years	814-798				
21. 2K 13:10-25	<b>Jehoash (Israel)</b>	37th of Joash	16 years	798-782				
22. 2K 14:1-22	<i>Amaziah (Judah)</i>	2nd of Jehoash	29 years				796-767	
			Overlap with Azariah				792-767	
23. 2K 14:23-29	<b>Jeroboam II (Israel)</b>		41 years				793-782	
		15th of Amaziah	Total reign				793-753	
			Beginning of sole reign				782	
24. 2K 15:1-7	<i>Azariah (Judah)</i>		52 years				792-767	
		27th of Jeroboam	Total reign				792-740	
			Beginning of sole reign				767	
25. 2K 15:8-12	<b>Zechariah (Israel)</b>	38th of Azariah	6 months				753	
26. 2K 15:13-15	<b>Shallum (Israel)</b>	39th of Azariah	1 month				752	
27. 2K 15:16-22	<b>Menahem (Israel)</b>	39th of Azariah	10 years				Ruled in Samaria	752-742
28. 2K 15:23-28	<b>Pekahiah (Israel)</b>	50th of Azariah	2 years				742-740	
29. 2K 15:27-31	<b>Pekah (Israel)</b>		20 years				In Gilead; overlapping years	752-740
		52nd of Azariah	Total reign				752-732	
			Beginning of sole reign				740	
30. 2K 15:32-38 2K 15:30	<i>Jotham (Judah)</i>		16 years				Co-regency with Azariah	750-740
		2nd of Pekah	Official reign				750-735	
			Reign to his 20th year				750-732	
			Beginning of co-regency				750	
31. 2K 16	<b>Ahaz (Judah)</b>		16 years				Total reign	735-715
		17th of Pekah	From 20th of Jotham				732-715	
32. 2K 15:30 2K 17	<b>Hoshea (Israel)</b>		9 years				20th of Jotham	732
		12th of Ahaz*	Total reign				732-722	
33. 2K 18:1—20:21	<b>Hezekiah (Judah)</b>	3rd of Hoshea*	29 years				715-688	
34. 2K 21:1-18	<i>Manasseh (Judah)</i>		55 years				Co-regency with Hezekiah	697-688
			Total reign				697-642	
35. 2K 21:19-26	<b>Amon (Judah)</b>		2 years				642-640	
36. 2K 22:1—23:30	<b>Josiah (Judah)</b>		31 years				640-609	
37. 2K 23:31-33	<b>Jehoahaz (Judah)</b>		3 months				609	
38. 2K 23:34—24:7	<b>Jehoiakim (Judah)</b>		11 years				609-598	
39. 2K 24:8-17	<b>Jehoiachin (Judah)</b>		3 months				598-597	
40. 2K 24:18—25:28	<b>Zedekiah (Judah)</b>		11 years				597-588	

\*These data arise when the reign of Hoshea is thrown 12 years in advance of its historical position.

*Italics denote kings of Judah.*  
Non-italic type denotes kings of Israel.

Adapted from: *A Chronology of the Hebrew Kings* by Edwin R. Thiele.  
© 1977 by The Zondervan Corporation. Used by permission.

# Kings of Israel

Dynasty	Name (Character)	Length of Reign*	Relation to Predecessor	Manner of Death	1 & 2 Kings	2 Chronicles
I	1 Jeroboam I (Bad)	931/30 - 910/09 = 22		Stricken by God	1 Kings 11:26-14:20	2 Chr. 9:29-13:22
	2 Nadab (Bad)	910/09 - 909/08 = 2	Son	Murdered by Baasha	1 Kings 15:25-28	
II	3 Baasha (Bad)	909/08 - 886/85 = 24		Died	1 Kings 15:27-16:7	2 Chr. 16:1-6
	4 Elah (Bad)	886/85 - 885/84 = 2	Son	Murdered by Zimri	1 Kings 16:6-14	
III	5 Zimri (Bad)	885/84 = 7 days	Captain of Chariots	Suicide by fire	1 Kings 16:9-20	
IV	6 Omri** (Bad)	885/84 - 874/73† = 12	Captain of Army	Died	1 Kings 16:15-28	
	7 Ahab (Bad)	874/73 - 853 = 21	Son	Wounded in battle	1 Kings 16:28-22:40	2 Chr. 18:1-34
	8 Ahaziah (Bad)	853 - 852 = 1	Son	Fell through lattice	1 Kings 22:40-2 Kings 1:18	2 Chr. 20:35-37
	9 Jehoram☆ (Bad)	852 - 841 = 11	Brother	Murdered by Jehu	2 Kings 3:1-9:25	2 Chr. 22:5-7
V	10 Jehu (Bad)	841 - 814/13 = 28		Died	2 Kings 9:1-10:36	2 Chr. 22:7-12
	11 Jehoahaz (Bad)	814/13 - 798 = 16	Son	Died	2 Kings 13:1-9	
	12 Jehoash‡ (Bad)	798 - 782/81 = 16	Son	Died	2 Kings 13:10-14:16	2 Chr. 25:17-24
	13 Jeroboam II (Bad)	793/92 - 753† = 40	Son	Died	2 Kings 14:23-29	
	14 Zechariah (Bad)	753 - 752 = 6 months	Son	Murdered by Shallum	2 Kings 14:29-15:12	
VI	15 Shallum (Bad)	752 = 1 month		Murdered by Menahem	2 Kings 15:10-15	
VII	16 Menahem (Bad)	752 - 742/41 = 10		Died	2 Kings 15:14-22	
	17 Pekahiah (Bad)	742/41 - 740/39 = 2	Son	Murdered by Pekah	2 Kings 15:22-26	
VIII	18 Pekah (Bad)	752 - 732/31† = 20	Captain of Army	Murdered by Hoshea	2 Kings 15:27-31	2 Chr. 28:5-8
IX	19 Hoshea (Bad)	732/31 - 723/22 = 9		Deposed to Assyria	2 Kings 15:30-17:6	

\*According to Edwin R. Thiele. \*\*Tibni coregency unsuccessful. †Overlapping/coregency.  
☆Also Joram. ‡Also Joash.



Dynasty	Name (Character)	Length of Reign*	Relation to Predecessor	Manner of Death	1 & 2 Kings	2 Chronicles
<b>I</b>	1 Rehoboam (Bad)	931/30 - 913 = 17	Son	Died	1 Kings 11:42-14:31	2 Chr. 9:31-12:16
	2 Abijam (Bad)	913 - 911/10 = 3	Son	Died	1 Kings 14:31-15:8	2 Chr. 13:1-22
	3 Asa (Good)	911/10 - 870/69 = 41	Son	Died	1 Kings 15:8-24	2 Chr. 14:1-16:14
	4 Jehoshaphat (Good)	873/72 - 848* = 25	Son	Died	1 Kings 22:41-50	2 Chr. 17:1-20:37
	5 Jehoram (Bad)	853-841* = 8	Son	Stricken by God (Bowels)	2 Kings 8:16-24	2 Chr. 21:1-20
	6 Ahaziah (Bad)	841 = 1	Son	Murdered by Jehu	2 Kings 8:24-9:29	2 Chr. 22:1-9
	7 * Athaliah (Bad) (Queen)	841 - 835 = 6	Mother	Murdered by Army	2 Kings 11:1-20	2 Chr. 22:1-23:21
	8 Joash (Good)	835 - 796 = 40	Grandson	Murdered by servants	2 Kings 11:1-12:21	2 Chr. 22:10-24:27
	9 Amaziah (Good)	796 - 767 = 29	Son	Murdered by court members	2 Kings 14:1-20	2 Chr. 25:1-28
	10 Azariah <sup>☆</sup> (Good)	792/91 - 740/39* = 52	Son	Stricken by God (Leprosy)	2 Kings 15:1-7	2 Chr. 26:1-23
	11 Jotham (Good)	750 - 732/31* = 18	Son	Died	2 Kings 15:32-38	2 Chr. 27:1-9
	12 Ahaz (Bad)	735 - 716/15* = 19	Son	Died	2 Kings 16:1-20	2 Chr. 28:1-27
	(BEST KING) 13 Hezekiah (Good)	716/15 - 687/86 = 29	Son	Died	2 Kings 18:1-20:21	2 Chr. 29:1-32:33
	(ONE OF THE WORST KING) 14 Manasseh (Bad)	697/96 - 643/42* = 55	Son	Died	2 Kings 21:1-18	2 Chr. 33:1-20
	15 Amon (Bad)	643/42 - 641/40 = 2	Son	Murdered by servants	2 Kings 21:19-26	2 Chr. 33:21-25
	16 Josiah (Good)	641/40 - 609 = 31	Son	Wounded in battle	2 Kings 22:1-23:30	2 Chr. 34:1-35:27
	17 Jehoahaz (Bad)	609 = 3 months	Son	Deposed to Egypt	2 Kings 23:31-33	2 Chr. 36:1-4
	18 Jehoiakim (Bad)	609 - 598 = 11	Brother	Died in Babylonian Siege?	2 Kings 23:34-24:5	2 Chr. 36:5-7
	19 Johoiachin (Bad)	598 - 597 = 3 months	Son	Deposed to Babylon	2 Kings 24:6-16	2 Chr. 36:8-10
	20 Zedekiah (Bad)	597 - 586 = 11	Uncle	Deposed to Babylon	2 Kings 24:17-25:30	2 Chr. 36:11-21

☆ Also Uzziah.

\* According to Edwin R. Thiele. Some overlapping/coregencies.

These are biblical numbers and do not always reflect coregencies.

\* Almost wiped out all of the babies in the messianic lineage (all except Joash)

# Genealogical Chart of the Kings of Judah

Paul Maier, *Josephus: The Essential Writings*, 388, adapted

## THE KINGS OF THE UNITED KINGDOM

SAUL

(c. 1030–1010 B.C.)

Maacah = DAVID = Bathsheba  
(c. 1010–971 B.C.)

Absalom SOLOMON  
(c. 971–931 B.C.)

### THE KINGS OF JUDAH

(after the division of the kingdom)

Maacah

REHOBOAM  
(931–913 B.C.)

ABIJAH  
(913–910 B.C.)

ASA = Azubah  
(910–870 B.C.)

ETHBAAL King of Phoenicia = Jezebel  
OMRI King of Israel = AHAB, King of Israel

JEHOSHAPHAT  
(870–848 B.C.)

AHAZIAH  
King of Israel

JORAM  
(JEHORAM)  
King of Israel

ATHALIAH  
(841–835 B.C.)

JEHORAM  
(848–842 B.C.)

*Killed by Jehu*

AHAZIAH = Zibiah  
(842–841 B.C.)

JOASH = Jehoaddin  
(835–800 B.C.)

Jecoliah = AMAZIAH  
(800–791 B.C.)

Jerusha = UZZIAH (AZARIAH)  
(791–740 B.C.)

AHAZ  
(735–715 B.C.)

Abijah

HEZEKIAH = Hephzibah  
(c. 721–686 B.C.)

JOTHAM  
(740–735 B.C.)

MANASSEH = Meshullemeth  
(696–641 B.C.)

Jedidah

AMON  
(641–639 B.C.)

Zebidah = JOSIAH  
(639–609 B.C.)

Hamutal

Nehushta

JEHOIAKIM  
(609–598 B.C.)

JEHOAHAZ  
(609 B.C.)

ZEDEKIAH  
(597–587 B.C.)

JEHOIACHIN  
(598–597 B.C.)

Zerubbabel,  
governor of  
Judah  
(520–515 B.C.)

Shealtiel

Shenazzar,  
(?—Sheshbazzar,  
“prince of Judah”)

The symbol “=” denotes “marriage to.”  
Names in capitals denote those who were rulers.

Those with dates indicate Kings of Judah

THE KINGS OF JUDAH AND ISRAEL

JUDAH

THE HOUSE OF DAVID  
(THE ONLY DYNASTY)

1. Rehoboam (1 K 12: 14:21-31) 931
  - a. followed Solomon on throne
  - b. precipitated disruption by foolish position
  - c. priests and Levites allied with Judah
  - d. invaded by Shishak
  - e. his cities and defences
  - f. he reigned 17 years
2. Abiam (1 K 15:1-8) 913
  - a. began in the 18th year of Jeroboam
  - b. his moral declension
  - c. his conflict with Israel
  - d. he reigned 3 years
3. Asa (1 K 15:9-24) 911
  - a. began in the 20th year of Jeroboam
  - b. his reformatory work
  - c. his league with Syria
  - d. his war with Baasha
  - e. reproved for defection
  - f. he reigned 41 years

ISRAEL

THE HOUSE OF JEROBOAM  
(FIRST DYNASTY)

1. Jeroboam I (1 K 12:12-14:20)
  - a. founder of northern kingdom by prophetic sanction
  - b. set up idolatry: bulls and rubble as priests
  - c. made Israel to sin
  - d. he reigned 22 years

913

910

909

886

885

884

THE HOUSE OF BAASHA  
(SECOND DYNASTY)

1. Baasha (1 K 15:27-16:7)
  - a. began in 3rd year of Asa
  - b. wars with Asa who allied with Ben-hadad
  - c. sinful reign of 24 years

2. Eloah (1 K 16:8-14)
  - a. began in 28th year of Asa
  - b. slain by Zimri
  - c. reigned 2 years

THE HOUSE OF ZIMRI  
(THIRD DYNASTY)

1. Zimri (1 K 16:15-20)
  - a. he reigned 1 week
  - b. he was besieged by Omri and perished in the palace

2. Tibni (1 K 16:21,22)
 

never ruled: Omri began 885

THE HOUSE OF OMRI  
(FOURTH DYNASTY)

- 880 1. Omri (1 K 16:16-28)
  - a. began in 31st year of Asa
  - b. moved the capitol to Samariah, defeated Tibnites
  - c. encouraged idolatry
  - d. he reigned 12 years

- 874 2. Ahab (1 K 16:29-22:40)
  - a. began in 39th year of Asa
  - b. Jezebel, his Phoenician wife, takes lead for Baal
  - c. Naboth's vineyard seized
  - d. frightful state of idolatry
  - e. Elijah: battle at Carmel, flight to Horeb, anointing of Hazael, Jehu, Elisha
  - f. wars with Syria
  - g. he reigned 22 years

870

4. Jehoshaphat (1 K 22:1-50)
  - a. began in Ahab's 4th year
  - b. set teachers of the law
  - c. completes reforms of Asa but retains high places
  - d. Alliance with Ahab to go to Ramoth-Gilead; Micahiah and Zedekiah prophesy
  - e. wicked alliance with Ahabziah
  - f. strengthened forces and garrisons
  - g. ships broken in Eziongeber word of Eliezer fulfilled
  - h. tribute money from Philis. and horses from Arabia
  - i. he reigned 25 years coregency began in 873

853

3. Ahaziah (1 K 22:50-53)
  - a. began in 17th year of Jehoshaphat
  - b. denounced by Elijah
  - c. fell through a lattice (2 K 1:1-19)
  - d. his sickness and inquiry of Baalzebub at Ekron
  - e. death predicted by Elijah
  - f. miraculous destruction of kings messengers
  - g. reigned 2 years

852

4. Jehoram (2 K 1:17-9:25)
  - a. follows Jeroboam
  - b. translation of Elijah and mantle on Elisha: miracles
  - c. rebellion of Moab by Mesha, Israel and Edom defeat Moab by water vision
  - d. Elisha: multiplies oil and promises a son to woman, a restoration of child's life, pottage, feeding 100
  - e. Naaman the leper, sin of Gehazi
  - f. Syria at war with Israel work of Elijah, seige of Samaria and deliverance
  - g. Shunamite's land restored

848

5. Jehoram (2 K 8:16-24)
  - a. 32 at coronation
  - b. non-in-law of Ahab and Jezebel
  - c. sinful course of Israel by high places and fornication
  - d. Yahweh stirred up enemies
  - e. revolt of Edom
  - f. died of incurable illness not buried with kings
  - g. he reigned 8 years coregency began in 853

Summaries of the Kings' Reigns  
Allen P. Ross, Dallas Theological Seminary (1 of 3)

## Summaries of the Kings' Reigns

Allen P. Ross (2 of 3)

125

6. Ahaziah (2 K 8:25-9:29) 841
- a. began in 12th year of Jehoram
  - b. house of Ahab counsellors
  - c. son of Jehoram and Athaliah
  - d. combined with Israel in a war with Syria
  - e. he reigned 1 year
  - f. Jehu slays Ahaziah at Megiddo
7. Joash (2 K 12:1-21) 835
- a. son of Ahaziah and grandson of Athaliah
  - b. 7 years old when began to reign
  - c. temple repaired under the direction of Jehoiada
  - d. hallowed things of Judah given to Hazael who then attacked
  - e. evil after death of priest Jehoiada, left high places
  - f. slain by his servants
  - g. he reigned 40 years
8. Amaziah (2 K 14:1-10) 796
- a. began in 2nd year of king Jehoash
  - b. was "right" but not with a perfect heart
  - c. slew the servants who had killed Joash
  - d. defeated the Edomites in valley of salt: 10,000
  - e. challenges Jehoash as the "thistle king:" defeated
  - f. slain by conspiracy
  - g. he reigned 29 years
- h. Elisha in Damascus: Hazael takes throne from BenHadad
- i. Israel and Judah at war with Syria, Jehoram wounded
- j. Jehu anointed by Elisha
- k. Jehu slays Jehoram
- 841 THE HOUSE OF JEHU  
(FIFTH DYNASTY)
- 841 1. Jehu (2 K 9:30-10)
- a. death of Jezebel
  - b. exterminates house of Ahab by word of Elijah
  - c. destroys the brothers of Ahaziah and Baalism in a feast house
  - d. a sinful follower of Jeroboam, but God's promise to Jehu: 4 generations
  - e. he reigned 28 years
- 814 2. Jehoahaz (2 K 13:1-9)
- a. began in 23rd year of Joash
  - b. sinful reign, groves left
  - c. delivered in hands of Syria to Hazael and Benhadad II
  - d. in answer to prayer a "savior" (Assyria) is given to deliver from Syria
  - e. he reigned 17 years
- 798 3. Jehoash (2 K 13:10-14:16)
- a. began in 37th year of Joash
  - b. death of Elisha: Moabite raised
  - c. recovered cities of Israel from Syria
  - d. defeats Syria: bow and arrows, strikes ground
  - e. defeats Amaziah of Judah and loots Jerusalem
  - f. he reigned 16 years

126

- 782 4. Jeroboam II (2 K 14:23-29)
- a. began in 15th year of king Amaziah
  - b. coregency began in 792/2
  - c. recovered lost territory of Israel through word of Jeroboam
  - d. works of Amos and Hosea
  - e. long and sinful reign of "41 years"
9. Uzziah (Azariah) (2 K 14:21,22 and 15:1-7) 767
- a. began in 17th year of king Jeroboam
  - b. coregency began in 792
  - c. sought God in the days of Zechariah
  - d. great capacity for ruling administration
  - e. defeated Philistines and Arabians
  - f. built engines and towers dug wells
  - g. assumed place of priest and smitten with leprosy
  - h. Isaiah appeared on scene commissioned at his death
  - i. he reigned for 52 years
- 753 5. Zachariah (2 K 15:9-12)
- a. began in 38th year of Uzziah
  - b. sinful 6 month reign
  - c. slain by Shallum: complete promise to Jehu
- THE HOUSE OF SHALLUM  
(SIXTH DYNASTY)
- 752 1. Shallum (2 K 15:13-15)
- a. began in 39th year of Uzziah
  - b. reigned but one month
  - c. slain by Menahem
- THE HOUSE OF MENAHEM  
(SEVENTH DYNASTY)
- 752 1. Menahem (2 K 15:16-22)
- a. horrible cruelties in the smiting of Tishbehi: pregnant women ripped up
  - b. Pul of Assyria invades: 1st tribute exacted
- 742 2. Pekahiah (2 K 15:23-26)
- a. began in 50th year of Uzziah
  - b. slain by his captain, Pekah and 50 Gileadites
  - c. he reigned 2 years
- THE HOUSE OF PEKAH  
(EIGHTH DYNASTY)
- 740 1. Pekah (2 K 15:27-31)
- a. began in 52nd year of Uzziah
  - b. coregency began in 752
  - c. counted as reigning 20 years but 9 by himself
  - d. Tiglath-pileser of Assyria carried away people
  - e. sinful reign ends when slain by Hoshea
10. Jotham (2 K 15:32-38)
- a. began in second year of Pekah
  - b. coregency began in 750
  - c. his mother the daughter of Zadok
  - d. permitted idols to remain
  - e. great building program of temple gate, walls of

Summaries of the Kings' Reigns  
Allen P. Ross (3 of 3), adapted

- Ophel, forts and towers in Judean hills
- f. put Ammonites under his tribute
- g. conflict with Rezin of Syria and Pekah of Israel

11. Ahaz (2 K 16:1-20) 732
- a. coregency began in 735
  - b. idolatrous acts: offered his sons on altar
  - c. attacked by Syrian-Israeli coalition
  - d. made an alliance with the Assyrians to save Judah from Syria: gave away the riches of temple

THE HOUSE OF HOSHEA  
(NINTH DYNASTY)

1. Hoshea (2 K 17:1-23) 732
- a. subdued by Shalmaneser of Assyria and made servant
  - b. conspired with So of Egypt and is shut in prison
  - c. Samaria is besieged for 3 years
  - d. Israel falls to Assyria and northern tribes taken into captivity as judgment from God (17:6-23)

Israel a province under Sargon II

12. Hezekiah (2 K 18:1-20:21) 716
- a. coregent in 728 since the city of Samaria fell in his 6th year
  - b. great revival: destroyed high places
  - c. Israel carried away by Shalmaneser-Sargon
  - d. Sennacherib's invasion of Judah over refusal of the payment of tribute
  - e. Rabshakeh's message, fear of Hezekiah, comfort from Isaiah, prayer of Hezekiah
  - f. answer from Isaiah: death of 185,000 Assyrians by Yahweh
  - g. Hezekiah's sickness and prayer for recovery
  - h. visit of Berodach-baladin of Babylon and the mistake of Hezekiah
  - i. Isaiah predicts captivity

705 Israel under control of Sennacherib  
701

13. Manasseh (2 K 21:1-18) 687
- a. began as a coregent in 697/696 and reigned 55 years
  - b. idolatry and sinfulness worse than pagan nations
  - c. judgment on him: taken captive to Assyria
  - d. his repentance, restoration and attempts at reform (prayer in Apocrypha)

14. Amon (2 K 21:19-26) 643
- a. followed his father's idolatry and not reform
  - b. slain by his servant
  - c. he reigned 2 years

15. Josiah (2 K 22-23:30) 641
- a. 8 years old at accession
  - b. piety: finds lost book of the law in the temple and leads reform
  - c. covenant with Yahweh to suppress idolatry
  - d. Jeremiah (not mentioned in Kings) associated
  - e. Josiah's foolish conflict with Pharaoh-Necho and is slain in battle

16. Jehoahaz (2 K 23:31-34) 609
- a. he reigned 3 months and was evil
  - b. land under tribute to Egypt
  - c. carried off by Necho II

17. Jehoashim (Eliakim) (2 K 23:34-24:6) 609
- a. placed on the throne by Pharaoh Necho II
  - b. battle of Carchemish in his fourth year
  - c. made the servant of Nebuchadnezzar (605-562) against whom he rebelled (first stage of captivity)

18. Jehoiachin (2 K 24:8-17) 598
- a. Jerusalem was looted by Nebuchadnezzar on the 15th or 16th of March in 597 B.C.
  - b. Jehoiachin and 10,000 people carried to Babylon including the mighty (second stage of captivity)

19. Zedekiah (2 K 24:18-25:21) 587
- a. also called Mattaniah
  - b. evil reign of 11 years and rebellion against Babylon
  - c. Jerusalem besieged in his ninth year (589) and famine
  - d. flight from Jerusalem, captured at Jericho, eyes put out after sons are slain
  - e. fall and destruction of Jerusalem
  - f. Zedekiah and people and treasures carried off to Babylon (third stage of captivity)
  - g. remnant left in the land under governorship of Gedaliah
  - h. Gedaliah is slain and people flees to Egypt
  - i. Kind treatment of Jehoiachin in Babylon by Evil-merodach: the book ends in a ray of hope!

# Chronicles

JERU. 14 TISHRI 2663 (1956 B.C.E.)

NEWS OF THE PAST

VOL. I, NO. 19

## KING SOLOMON DEDICATES TEMPLE

### After 3 Years at Sea

### Our Fleet is Back

By a Staff Writer

ETZION-GEVER, 13 Tishri.—Nineteen of King Solomon's 29 ships that set out for the distant shores of Ophir 3 years ago returned to Israel today, bringing with them a strange assortment of plants and animals, as well as large quantities of gold and other treasures. The vessel was lost in a heavy storm on the high seas. Her crew was saved, but her cargo went to the bottom of the sea.

The unloading of the fleet's precious cargo was begun at once.

#### Talking Birds

Among the animals that attracted particular attention was a large, colorful bird from whose round beak issued strange, shrill sounds. The sailors wear that these sounds sometimes take the form of human speech!

As soon as it was learned yesterday that the ships were approaching Etzion-Gever, an armed guard was rushed to the harbour area, to forestall any attempts by

#### PRECAUTION

In order to minimize any losses that might occur as a result of piracy or some natural disaster, the gold and most of the other treasures taken at Ophir were divided among all the vessels. The total quantity of gold brought from Ophir is a closely guarded secret.

Domestic bands or by Arabian or Ammonite slaves from the nearby mines and quarries, to carry off part of the cargo that is being unloaded.

The captain of one of the vessels expressed his

#### REINFORCEMENTS SENT TO TADMOR

ADMON, 11 Tishri.—Another batch of Israelite soldiers arrived here from Damascus today to reconstruct the growing threat from Hazon, the Aramean rebel leader who last week gained control of the Euphrates, his time striking deep into Israelite territory before returning to his base in the north. Rezon, currently the sole threat to the peace in King Solomon's vast realm, served as an officer in the army of the former king of Aram, Hadadeter, who was beaten into submission by King David's forces. Rezon's king, Hazon, is a defeat and has gathered around him a band of soldiers with whom he conducts intermittent raids across the Israelite border. It is his avowed aim to restore Aramean power at Damascus. To thwart such a move King Solomon has built a fortress at Tadmor between the Euphrates and Damascus into a strong- hold with a permanent garrison.

### 7-Day Celebration Throughout Israel

(Royal News Service)

The Office of the King's Recorder of Events announced yesterday afternoon that the dedication celebration would continue throughout the country for the remaining six days of the Tabernacles festival. The two holidays will be observed simultaneously. Families from all parts of the country will thus have an opportunity to come to Jerusalem to bring their sacrifices.

A notice has been issued by the Office of the High Priest, conveying a solemn warning to Israelites not to sacrifice on any of the "high places." It also emphasizes that henceforth no sacrifices of any kind may take place outside the Temple in Jerusalem, even in the local sanctuaries which had previously been used by the official priest-hood.

#### ATTENTION, VISITORS FROM ABROAD:

There is important news for you ON PAGE 2

### Expect 100,000 Offerings

(Royal News Service)

Priests attached to the Temple Reception Center for the people's offerings estimate that in the course of the 7-day holiday the number of sacrifices brought to the Temple will exceed 100,000.

Preparations for handling so huge a number of offerings were begun 12 months ago, and the priests say they are equipped to cope with the situation.

Special cattle markets have been set up at the city gates, to cater to those who have come a long way and did not bring their animals with them.

#### Provision for Needy

The King, furthermore, has issued instructions to the effect that family heads who are not in position, financially, to buy a sacrificial animal may, upon presentation of a written testimonial signed by the Elders of their town or village, receive a sheep from the Royal Pen.

"It is His Majesty's wish," the royal announcement states, "that every house in Israel, without exception, should bring its sacrifice in the Temple."

### Leads People in Solemn Procession

By a Staff Writer

The Temple of the Lord, constructed by King Solomon and completed only a few days ago, was solemnly dedicated here yesterday morning with the installation of the Ark of the Covenant in the Holy of Holies — the innermost chamber of the Sanctuary.

Hundreds of thousands of joyous celebrants from all over the country filled the Temple square, the surrounding mountain slopes, and all the streets of the city, in order to watch the procession and the ceremony which followed.

Never in the history of this nation has there been such a glorious spectacle of pagantry and splendour, and the people made the most of the occasion.

The day also marked the commencement of the Feast of Tabernacles.

Highlight of the dedication ceremony was the prayer offered up by King Solomon. This was followed

(Excerpts from King Solomon's Prayer — Page 3)

ed by the bringing of the holiday sacrifices, as prescribed in the Law of Moses. Special services will be held all week to enable every citizen to bring his sacrifice.

Focus of Activity Its golden exterior gleaming in the early autumn

sunlight, the Temple was the focus of all activity in the city throughout the day.

In the early morning, King David and other members have been inspected and pronounced ready for occupation and worship, a select company of priests removed the Holy Ark and the ritual vessels from the tent in the City of David where for years they had waited for their permanent home.

King Solomon and High Priest Zadok, escorted by the Royal Bodyguard and the Guards Regiment, led the procession through the crowded streets.

The priests were followed by the Ark of the Covenant and the Levite musicians, who accompanied the festive atmosphere with music and song. Then came hundreds of Jews or priests and Levites, elder statesmen, tribal representatives, and guests from abroad.

Thousands of ordinary citizens joined in at this point and followed until the procession came to a halt at the Temple Mount.

There the troops guarding the King's presence, to avoid profaning the Temple area with their weapons. To the accompaniment of several trumpets, the outer gates of the Temple opened, and King, High Priest, and Elders entered the outer courtyard.

#### Levites Sing

When they reached the fifteen steps leading to the Temple Entrance (see diagram on page 3), 240 musicians and 200 vocalists, flanking the staircase, struck up David's psalm, "The Lord is the Lord," intoned by the words:

"Lift up your heads, O you gates, and be lifted up, you everlasting doors — and the King of glory shall come in!"

"The Ark now passed into the hands of Zadok, the High Priest, and his two sons, who deposited it in the Holy of Holies. The King did not enter this most sacred part of the Temple.

As the priests emerged from the inner chamber,

#### NO IRON USED

No iron was used in any of the construction work for the Temple, since it was considered improper to use, for the purpose of building this sacred edifice, a metal from which war weapons are made. Similarly, King David was denied the honour of building the Temple because of his life-long association with bloodshed and war.

a heavy cloud descended on the Sanctuary and filled its interior.

#### The King's Prayer

When all the sacred vessels had been put in their proper places, a signal for silence was given, and the excited hubbub of the throng gradually subsided. King Solomon waited for complete silence, then intoned the first prayer heard in the Temple.

Rising and turning to the multitude, the King then blessed the people, exhorting them to "let your eyes not be perfect with the Lord your God".

Then came the sacrifices, with King Solomon leading the ark and the people following suit, one by one. Temple guards briefed for their new task kept order, and the "business of the day" was transacted without incident.

The sacrifices were resumed this morning and will be continued until the end of the Tabernacles festival.

#### Veteran Priest Among Marchers

Among the notables following the Ark of the Covenant through the streets of David's City yesterday was old Avitamar, who served as High Priest in David's time.

Avitamar was exiled to Anatot for his part in the abortive Adoniyahu uprising against Solomon after King David's death. At the request of King Solomon's mother, Bathsheba, the venerable ex-High Priest was granted special permission to come to Jerusalem so as to be able to march with the great priests on this great occasion.

He is the only one of those who had participated in the anti-Solomon conspiracy who was not executed. Said Solomon at the time:

"I shall not put you to death, because you bore the Ark of the Lord before my father David, and because you have been afflicted in all wherein my father was afflicted."

## Queen of Sheba Arrives in Jerusalem

By a Staff Writer

Amidst a fanfare of drums and trumpets, and with thousands straining to catch a glimpse of "the most beautiful woman in the world", the Queen of Sheba today made her entry into Jerusalem. Her journey had taken the Queen some 1600 miles — from the Kingdom of Sheba, in southern Arabia, to the capital of Israel — in just under three months.

The Queen arrived with a powerful escort mounted on horses and dromedaries, she herself being borne aloft in a specially-built litter supported by four gigantic Nubian attendants. A long train of animals — including some enormous beasts never before seen in Israel — brought the Queen's gifts of gold, ivory and precious stones for King Solomon.

Battle of Wits His Majesty the King met the Queen of Sheba at the entrance to the Royal Palace. The Queen was much moved, she declared later, by the reception and by the grandeur of the Court which, she said, greatly surpassed her expectations, formed on the basis of the glowing reports that had reached her ears in her far-off domain. In particular, the Queen had heard of King Solomon's skill in writing poetry and propounding riddles. The Queen — herself quite adept in these two fields — has let it be known that she is looking forward to the opportunity of matching wits with the sagacious Solomon.

Among His Majesty's courtiers, the outcome of this mental tournament between the world's wisest man and the world's most beautiful woman is awaited with eager anticipation.

Benaiah ben Yehoiadab has been appointed by King Solomon to act as the Queen's personal bodyguard as the head of her bodyguard during her stay in Jerusalem.

### Commercial Mission?

By a Staff Writer

The air of the capital is buzzing with rumours about the real motive of the Queen's visit to King Solomon's court in Jerusalem. Curiosity, politics, romance, the quest for knowledge — all these have been mentioned.

Trained local observers, however, incline to the view that the Queen's motive is an economic one, and that behind her mission to Jerusalem lies the desire to come to some sort of commercial understanding with the powerful Israelite Regent.

This view is based on the economic facts of life in this region. Until a few years ago the entire Arabian-Ethiopian trade was in the hands of the Queen of Sheba — and a lucrative source of income it was, too.

Then came the Israel

merchant fleet and began to cut into Sheba's monopoly by plying the sea routes from Elath to Ophir, stopping at Arabian and Ethiopian ports on the way.

Since transportation by sea is faster, safer, and more efficient than overland traffic — especially on long-distance journeys — the Queen of Sheba, who owns no ships, found herself unable to compete with King Solomon's new merchant navy, and her caravans lost a tremendous amount of trade.

It is believed in economic circles here that the Queen will try to get Solomon to limit his commercial activities to his former sphere of influence, or, failing that, to obtain from him a subsidy to compensate for the trade he is taking away from her.

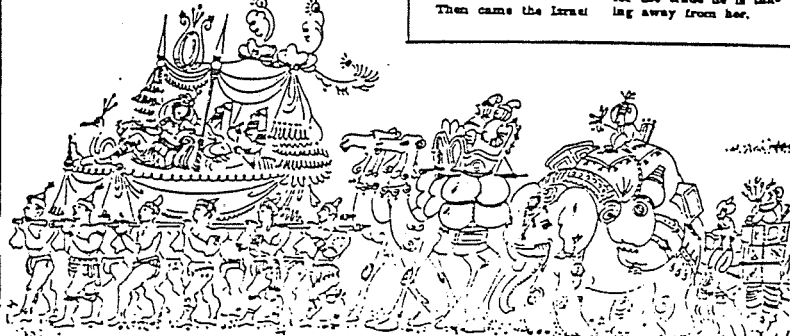

#### JERICO JOINS IN

JERICO (CNS).— Residents of this city were unable to go up to Jerusalem for the inauguration, stood for hours at the western city gate — their eyes glued on the Hills of Jerusalem.

When they saw the column of smoke rise to the heavens, they knew that at that moment the dedication sacrifice had been offered up — and accepted. The people promptly fell on their faces and called out three times: "The Lord is God!"

# Chronicles

NEWS OF THE PAST

JERUSALEM, 16 ZIV, 2527 (923 B.C.E.)

VOL. I, NO. 16

## After a Century of Unity, Our Nation is Divided

# NORTH PROCLAIMS JEROBOAM KING

### King Rehoboam Says: 'Jeroboam Egyptian Puppet'

(Chronicles News Service)

The man behind today's revolt is Jeroboam ben Nebat, and his real motive is to weaken Israel so as to deliver her later into the hand of his friend and protector, Pharaoh Shishak of Egypt. This charge was made this afternoon by His Majesty King Rehoboam, in a public address delivered in front of the Royal Palace in Jerusalem.

"It was Pharaoh," said the King, "who instigated Jeroboam to split our people. He fully understands that it was through our inactivity, through our loyalty to our King, and through our attachment to the Temple of the Lord, that we became independent and mighty."

Should Shishak succeed in crushing these unifying forces, King Rehoboam warned, he will succeed in destroying our power as a nation — and we will eventually drop into his hands like so much ripe fruit."

Objected to 'Ultimatum'

Explaining his action as a necessary measure, he said that he would have been "merely willing to discuss with the people the matter of alleviating the tax burden" but decided against such a course when the demands were put "in the form of an ultimatum."

The King reminded his audience of the prosperous and glorious days of his father's and grandfather's reigns, pointing out that had been their taxes that had made this prosperity possible.

King Rehoboam ended his address with a general call to arms.

### REBELS PICK SHECHEM AS THEIR CAPITAL

(Chronicles News Service)

SHECHEM, 15 Ziv.—The city of Shechem is to be the capital of the northern kingdom, according to an announcement made immediately after his coronation by Jeroboam, the son of Nebat.

The choice of this centrally located mountain city in the heart of the Ephraim district as Israel's capital does not come as a surprise to anyone. In fact, it has been a foregone conclusion that the elders and the people of Shechem would be rewarded for their support of Jeroboam's cause, by having their city chosen as the capital. Usually reliable sources say that a specific agreement along these lines has been in existence for the past week.

Historical Sites

Historical associations give Shechem a further claim to recognition.

It was near this city that God promised the Land of Canaan to our ancestor Abraham. And when Jacob returned to the Promised Land after a 22-year absence, he bought a parcel of land from the natives inhabiting Shechem — and here Joseph's body was later buried.

Shortly after the conquest of Canaan, Shechem was the scene of a grand convocation, at which all the tribes assembled, and, with Joshua officiating, renewed their bond with God's Law. Joshua's farewell address to the people likewise was delivered here.

Avimelech, son of Judge Gideon, ruled the surrounding territory from Shechem, but the city was destroyed when its citizens rebelled against the tyrant.

Shechem is one of the cities of refuge as well as a Levitical city.

Geographical Drawbacks

From a military point of view, Shechem is a disadvantageous location. It had been expected that the King would, in the

### Revolt Against Rehoboam Follows Refusal to Grant People Tax Relief

**Bulletin**

SHECHEM, 16 Ziv.—All but two of Israel's twelve tribes today joined the Elders of Shechem in proclaiming Jeroboam the son of Nebat as their king. Judah and Benjamin alone remained loyal to King Rehoboam and the House of David.

The ceremony took place only three hours after King Rehoboam's flat rejection of the Assembly's demands for tax-relief had precipitated a riot, in the course of which Tax Commissioner Adoram was killed by the furious mob and the King himself was forced to flee to Jerusalem, his capital, in the greatest of haste.

The coronation of Jeroboam by the rebels shuts the door on any hopes for conciliation between North and South.



King Rehoboam

(From an earlier CNS despatch:)

When the Shechem Assembly (comprising representatives of the northern tribes, in addition to the townspeople of Shechem) gathered in the city's central square this morning to await King Rehoboam's promised reply to their demands of three days ago, an almost tangible feeling of tension pervaded the atmosphere.

Jeroboam again was among those present. Three days ago he had acted as mouthpiece for the people of the North when King Rehoboam had been handed what really amounted to an ultimatum.

"Lighten the heavy burden your father placed upon us," was the demand, "and we will serve you."

The implication was a clear one: If you fail to do so — we will renounce our allegiance to you.

Without betraying his inner reaction to this veiled threat, the King had dissolved the Assembly on the spot, ordering the people to return in three days' time for his answer.

This morning King Rehoboam, stalling for time, tried to put off his reply another day. But the representatives of the North would not hear of it. A rumour had spread through the town yesterday that the King had sent to Jerusalem for troops.

The Northern leaders bluntly told the King that if he did not give his answer at once, they would not be responsible for anything the people might do.

Categorical 'No'

Two hours later the answer came. It was a categorical "No."

Still thinking he was in control of the situation, King Rehoboam confronted the Assembly in the open square and delivered his reply personally.

"How dare you come to

### Tension on Both Sides Judah's Army On the Alert

By a Special Correspondent

covering the capital during the critical hours following the insurrection at Shechem

(Voon)

The nation is on the brink of civil war.

King Rehoboam is mustering a large body of troops, with which he plans to march north and put down the revolt before the rebels have a chance to consolidate their gains.

Both sides are mobilizing. And that usually means war.

Tension Grows

(Three hours later)

The proclamation is being read with the King's Herald in full battle dress are attracting to the city by the thousands.

The tension is growing.

### Rehoboam's Harsh Reply Shocks Observers

By Our Correspondent

SHECHEM.—King Rehoboam's negative response to the people's demands for tax relief, and the harsh language in which it was rendered, came as a shock to most observers here.

It had been expected that the King would, in the

main, grant the people's request, which was generally regarded as reasonable — even in Southern circles. Tempers, on both sides, had been given a chance to cool; there would be no excuse, after a three-day delay, for impulsive words or deeds.

That Rehoboam would couch his answer in rather stern language, in order to "save face" with the people, was taken for granted. But it was hardly thought that the answer would be as harsh and unconditional "No."

Again, most observers agreed that the present split, while deeply rooted in the people's past, could have been avoided, had the situation been handled with a little statesmanship.

Instead, events were allowed to take their natural course. And the division having once been made, little hope is held out for a reconciliation in the foreseeable future.

Then suddenly an old and dignified man stepped to the fore. His name quickly passed from mouth to mouth: "Shemaiah the Prophet!"

The prophet addressed the throng — his words leaping forth from his lips like a stinging flame. He cried out, he supplicated, he wept, he thundered — and he commanded:

"In the name of the Lord of Hosts — do not go to war against your brethren! The cleavage your Kingdom has suffered is the work of the Lord, and we must accept it as such."

The prophet's impassioned plea for peace may have turned the tide.

We noted, with satisfaction and considerable relief, that the King and his advisors were visibly impressed.

### Tyre to Maintain Strict Neutrality

(Chronicles News Service)

TYRE, 15 Ziv.—Following a hurried consultation at the court of King Hadasar, the Tyrant Government today decided not to intervene in the current Israelite dispute and not to favour one side over the other.

A Government spokesman said, after the session, that Tyre was interested in maintaining commercial relations with both North and South.

The King, he said, regretted that this division had come about. The emergence of two governments where there had been one would undoubtedly raise certain difficulties in the matter of the Israelites' commercial relations with other nations.

Need for Good Will

These difficulties, however, the spokesman added, can be overcome to a large degree, provided there is good will and co-operation on both sides.

While, in the past, the bulk of the Phoenician trade has been with the southern part of the country, it is not believed that Jeroboam will try to hamper the passage of goods to and from Judah — particularly since he himself will be in need of Phoenician timber and, hence, of Phoenician good will, in the months and years ahead.

### Reaction Abroad Aram, Ammon Hail Split; Moab Leans to Rebels

(Foreign News Service)

DAMASCUS, 15 Ziv.—A loud cheering and a spontaneous demonstration of joy in front of King Rezon's Palace greeted the report from Shechem that the Kingdom of Israel had split into two separate monarchies.

Rezon has enjoyed increasing popularity here ever since he succeeded, four years ago, in restoring independence to a large segment of Aramean territory that had been under King Solomon's rule.

The present split is looked upon in Damascus, as paving the way to further Aramean territorial gains at Israel's expense.

### Tax Chief Killed by Angry Mob

SHECHEM, 15 Ziv.—There was but one casualty in this morning's revolt against King David's dynasty.

Adoram, veteran Tax Commissioner under King David and King Solomon, was stoned to death by the enraged mob when he was sent by King Rehoboam to quell the riot which had broken out.

### STOP PRESS

BETHEL, 15 Ziv (CNS).—Acting on the advice of priests, Jeroboam decided late this afternoon to revoke the calf as the figure representing the God of Israel. Golden calf-images are to be erected in two cities — Dan, in the extreme north; and Bethel, in the south.

The chief purpose of this move is believed to be to divert the people's attention from Judah's capital to prevent the mass pilgrimages to Jerusalem that have become customary since the construction of the Temple.

### Ammon Ignored King Rehoboam's Advice

Special to CHRONICLES

King Rehoboam's decision to reject the demands of the people and to "save face" by taking against the advice of the older members of his council, is learned from reliable sources late this afternoon.

The Elders, who had seen many years of service under King Solomon, had vocated that the King should, at least temporarily, accede to a lowering of taxes, so as not to arouse a mob of angry men.

The King, however, inclined to the advice given by the younger members, which was to "save face" over them and show that the word of the King is law.

### Rupture Was Forecast

Today's historic events at Shechem were foretold by the Prophet Achiah, in a private talk with Jeroboam, four years ago.

The text of the forecast, released today jointly by Jeroboam and the Prophet is as follows:

"Behold, said the Lord, I will rend the kingdom out of the hand of Solomon and will give ten

### Egyptian Guard

No sooner had Rehoboam's chariot disappeared from view than a cry went up, heavily armed soldiers springing up as if from nowhere and took up positions around the crowded square.

The warriors were later identified as Libyans from Egypt who accompanied Jeroboam on his return from his exile in that country and who are slated to serve the rebel king in the capacity of bodyguards.

### Moab Leans to Rebels

KIR MOAB, 15 Ziv.—The position of Moab, in view of the new situation that has arisen west of the Jordan, has not yet been decided. It is believed, however, that Moab will follow the lead of the trans-Jordanic tribes on her northern border.

If, as is to be expected, Reuben and Gad join the revolt, Moab will align herself with the North and pay tribute to Jeroboam's Government.

### Tyre to Maintain Strict Neutrality

tribes to you, because the people have forsaken me and have not walked in my ways, to keep my statutes and judgments, as did David his father.

"To his son I will give one tribe, that David my servant may have a light always before me in Jerusalem, and the city I have chosen to put my name there. And you shall be king over Israel."

### STOP PRESS

BETHEL, 15 Ziv (CNS).—Acting on the advice of priests, Jeroboam decided late this afternoon to revoke the calf as the figure representing the God of Israel. Golden calf-images are to be erected in two cities — Dan, in the extreme north; and Bethel, in the south.

The chief purpose of this move is believed to be to divert the people's attention from Judah's capital to prevent the mass pilgrimages to Jerusalem that have become customary since the construction of the Temple.

## Modern News Clips on Solomon

Newspaper Sources and Dates from Dallas, Texas before 1985

### I Kings

#### Cost Of Solomon's Temple

The cost of the most magnificent of modern buildings is a trifle compared to that of Solomon's temple, which, according to estimates given in the bulletin of the Illinois Society of Architects, reached the tremendous total of more than \$87,000,000,000 according to present-day values. Solomon's temple and its internal decorations and the paraphernalia was one of the wonders of the olden times. According to Villapardus, the talents of gold silver and brass used in its construction were valued at the enormous sum of \$34,399,110,000.

The worth of jewels is generally placed at a figure equally as high. The vessels of gold, according to Josephus, were valued at 140,000 talents, which reduced, according to Chapel's reduction tables, to every-day coinage equals the sum of \$1,876,481,515. The vessels of silver, according to the same authority, were still more valuable, being set down as worth \$3,246,720,000. The priests vestments and robes of singers, \$10,050,000; the trumpets were worth \$1,000,000.

To the above add the expense of building materials, labor and the like, and some wonderful figures present themselves. Ten thousand men hewing cedars, 60,000 bearers of burdens, 80,000 hewers of stone, 3,300 overseers, all of whom were employed for seven years, and upon whom, beside their wages, Solomon bestowed \$33,669,885.

If the daily food was worth forty-five cents each, the sum total for feeding this army of workmen during the time of building totals up to \$344,385,440. The material in the rough is estimated as having been worth \$12,726,685,000. The several estimates show the total cost to have been, \$87,212,210,840.

#### King Solomon's mine said found

WASHINGTON (UPI) — King Solomon's lost gold mine, the fabled biblical Ophir, appears to have been found between Mecca and Medina in Saudi Arabia.

According to a report Sunday from the U.S. Geological Survey, a team of American and Saudi geologists believes the most likely place for the rich mine of the 10th century B.C. is a site called Mahd Adh Dhabab (Cradle of Gold).

Dr. Robert Luce, a USGS geologist and a member of the team, said engineers who operated the mine between 1939 and 1954 suspected it was the biblical Ophir.

The Bible reports that King Solomon, who reigned from 970 to 931 B.C., and King Hiram brought 31 tons of gold to Jerusalem from Ophir. Although four books of the Bible mention Ophir, its location is never pinpointed.

The Revised Standard Edition of the Bible in I Kings, Chapter 9, Verse 26, speaks of those who "went to Ophir, and brought from there gold, to the amount of four hundred and twenty talents; and they brought it to King Solomon."

The rest of I Kings deals with Solomon and the Queen of Sheba, an interesting tale, but biblical researchers have been equally fascinated by the legendary Ophir, thought to be in Arabia.

"Our investigations have now confirmed that the old mine could have been as rich as described in biblical accounts and, indeed, is a logical candidate to be the lost Ophir," Luce said. "We believe the legendary King Solomon's lost mines are no longer lost."



"No, Francine. Solomon did not have 300 porcupines."



## 204 / ethics: alternatives and issues

subject. Romans chapter one speaks of homosexuality as that which "exchanged natural relations for unnatural . . ." (v. 26). It is a "shameless act" which results from vile passions (v. 27). In another passage Paul wrote, "Do not be deceived; neither the immoral, nor idolaters, nor adulterers, nor homosexuals . . . will inherit the kingdom of God" (1 Cor. 6:9). These are all a perversion of the proper use of sex. Heterosexual acts are wrong outside marriage because they set up a husband-wife relation between those who are not husband and wife. Homosexual acts are wrong because they set up a unique husband-wife relation between those who cannot be husband and wife, since they are both of the same sex.

Of course, the biblical prohibitions on homosexuality do not refer to close friendships (with physical affection) between those of the same sex. Such friendships are both normal and beautiful. David and Jonathan are a classic example. The Scriptures say, "The soul of Jonathan was knit to the soul of David, and Jonathan loved him as his own soul" (1 Sam. 18:1). Intimate friendship is one thing; illegitimate and unnatural sexual encounters are quite another thing.

4. *The Role of Sex in Multiple Marriages* — There is little question that polygamy was permitted by God in biblical times. Even some of the great saints had several wives (cf. Abraham, David, Solomon). The real problem is not whether God *permitted* polygamy but whether He *planned* it. That is, was polygamy, like divorce, something God tolerated but did not really desire?

There is ample evidence, even within the Old Testament, that polygamy was not God's ideal for man. That monogamy was His ideal for man is obvious from several perspectives. (1) God made only one wife for Adam (Gen. 2:18f), thus setting the ideal precedent for the race. (2) Polygamy is first mentioned as part of the wicked Canite civilization (Gen. 4:23). (3) God clearly forbade the kings of Israel (leaders were the persons who became polygamists) saying, "And he shall not multiply wives for himself, lest his heart turn away again" (Deut. 17:17). (4) The saints who became polygamists paid for their sins. 1 Kings 11:1,3 says, "Now King Solomon loved many foreign women. . . . He had seven hundred wives, princesses, and three hundred concubines; and his wives turned away his heart." (5) The greatest polygamist of the Old Testament, Solomon, gave testimony to the fact that he had only one true love, for whom he wrote "The Song of Songs." The Canticles stand as the greatest polygamist's greatest rebuke to polygamy. Even Solomon with his 1,000 wives had only one true love. (6) Polygamy is usually situated in the context of sin in the Old Testament. Abraham's marriage of Hagar was clearly a carnal act of unbelief (Gen. 16:1f). David was not at a spiritual peak when he added Abigail and Ahinoam as his wives (1 Sam. 25:

## the christian and sex / 205

42, 43), nor was Jacob when he married Leah and Rachel (Gen. 29:23, 28). (7) The polygamous relation was less than ideal. It was one of jealousy among the wives. Jacob loved Rachel more than Leah (Gen. 29:31). Elkanah's one wife was considered a "rival" or adversary by the other, who "used to provoke her sorely, to irritate her . . ." (1 Sam. 1:6). (8) When polygamy is referred to, the conditional, not the imperative, is used. "If he takes another wife to himself, he shall not diminish her food, her clothing, or her marital rights" (Ex. 21:10). Polygamy is not the moral ideal, but the polygamist must be moral. (9) The New Testament sets down monogamy as a precondition for church leaders. "Now a bishop must be above reproach, the husband of one wife . . ." (1 Tim. 3:2), wrote the apostle. (10) Monogamy was not only required for church leaders but it was recommended for all men. Paul wrote, "But because of the temptation to immorality, each man should have his own wife and each woman her own husband" (1 Cor. 7:2).

There are other arguments against polygamy, such as the relatively equal number of males and females in the world, which would seem to imply that one woman is made for one man. However, it must be conceded that polygamy is better than immorality, even though it is not as good as monogamy. At least, polygamy is a closed system; it is not free love. It is better to take a woman as a second wife than to use her as a harlot, even though both fall short of God's ideal. Polygamy is at least a relationship where the other can be treated as a person and not merely used as a thing. Nonetheless, polygamy is inferior to monogamy because one cannot have a unique (one-of-a-kind) relationship with more than one wife. The other wives will never be more than second best and not part of that most intimate union which God designed for marriage. Jealousy and hatred will be natural outcomes of the polygamous relation.

## II. HIERARCHICAL BASIS FOR A CHRISTIAN VIEW OF SEX

Does not the special case of polygamy provide an exception to the moral principle that sex is to be a unique and abiding personal relation between a man and a woman? Furthermore, does not the justifiable case of divorce (viz., when one's partner has been unfaithful) mentioned by Jesus (Matt. 19:9) provide an exception to the morality of the marital bond? From a biblical and hierarchical point of view the answer to both questions is no. There are no *exceptions* to the singularity of the marital relation (i.e., one man for one woman); there are only some *exemptions* in view of higher obligations. Likewise, there are no legitimate exceptions to the permanence of the marriage bond (divorce as such is wrong); there

## Did God Approve of Solomon's Polygamy?

Norman Geisler, *Ethics: Alternatives and Issues*, 204-5  
(See also page 217 of these notes)

## Polygamy in the Line of Judah

### I. Introduction

- A. Polygamy is the practice of a single husband having more than one wife. This is practiced for a variety of reasons, chiefly being men's sexual desires and desire to have as many sons as possible to continue their lineage and secure their throne.
- B. Since God blessed Adam with Eve in Eden, God's ideal has always been one woman for one man. However, pagan views of antiquity convinced kings and wealthy men that their strength and blessing was shown in having multiple wives.

### II. How Large were the Families in the Kingdom of Judah?

<i>King</i>	<i>Wives</i>	<i>Concubines</i>	<i>Total</i>	<i>Sons</i>	<i>Daughters</i>	<i>Ref</i>
David	8+	Yes	Many	20+	Many	1 Sam 27:3; 2 Sam. 3:2-5; 5:13-16
Solomon	700	300	1000			1 Kings 11:3; 1 Chron. 3:10
Rehoboam	18	60	78	28	60	2 Chron. 11:21
Abijah	14		14+	22	16	2 Chron. 13:21
Jehoram	Many					2 Chron 21:14
Joash	2					2 Chron. 24:3

### III. Applications Today

- A. Scripture is clear about the many problems associated with deviating from God's ideal in the Garden of Eden. These problems follow those with multiple sexual partners:
  - 1. Bitterness and rivalry often resulted from multiple wives.
  - 2. Various sons who each had a different mother complicated the second generation too
  
- B. The blessings of faithfulness to a single partner are numerous:
  - 1. Lack of guilt—the sexual life of a monogamous husband is blessed (Prov. 5:15-19)
  - 2. Simplicity in the home rather than jealousy between wives or sexual partners

### IV. Do You Agree or Disagree?

To explore your own ideas on this vital subject, please mark as A, U, or D beside each statement below to show whether you Agree, are Unsure, or Disagree with the teaching.

- A. God allowed the kings of Judah to marry several wives.
- B. Polygamy is always wrong.
- C. Polygamists who become Christians should divorce the rest of their wives that came after their initial marriage.

### V. Conclusion

In today's so-called "sexual revolution" people are honored if they have had multiple sexual partners. The late NBA basketball star Wilt Chamberlain was said to have had sex with over 50,000 women (this averaged three daily during his ages 20-60).

However, man is never happier than when he follows God's instructions—and this applies particularly in the sexual realm.

# Elijah's Travels

Donald Campbell, Dallas Theological Seminary (class handout)

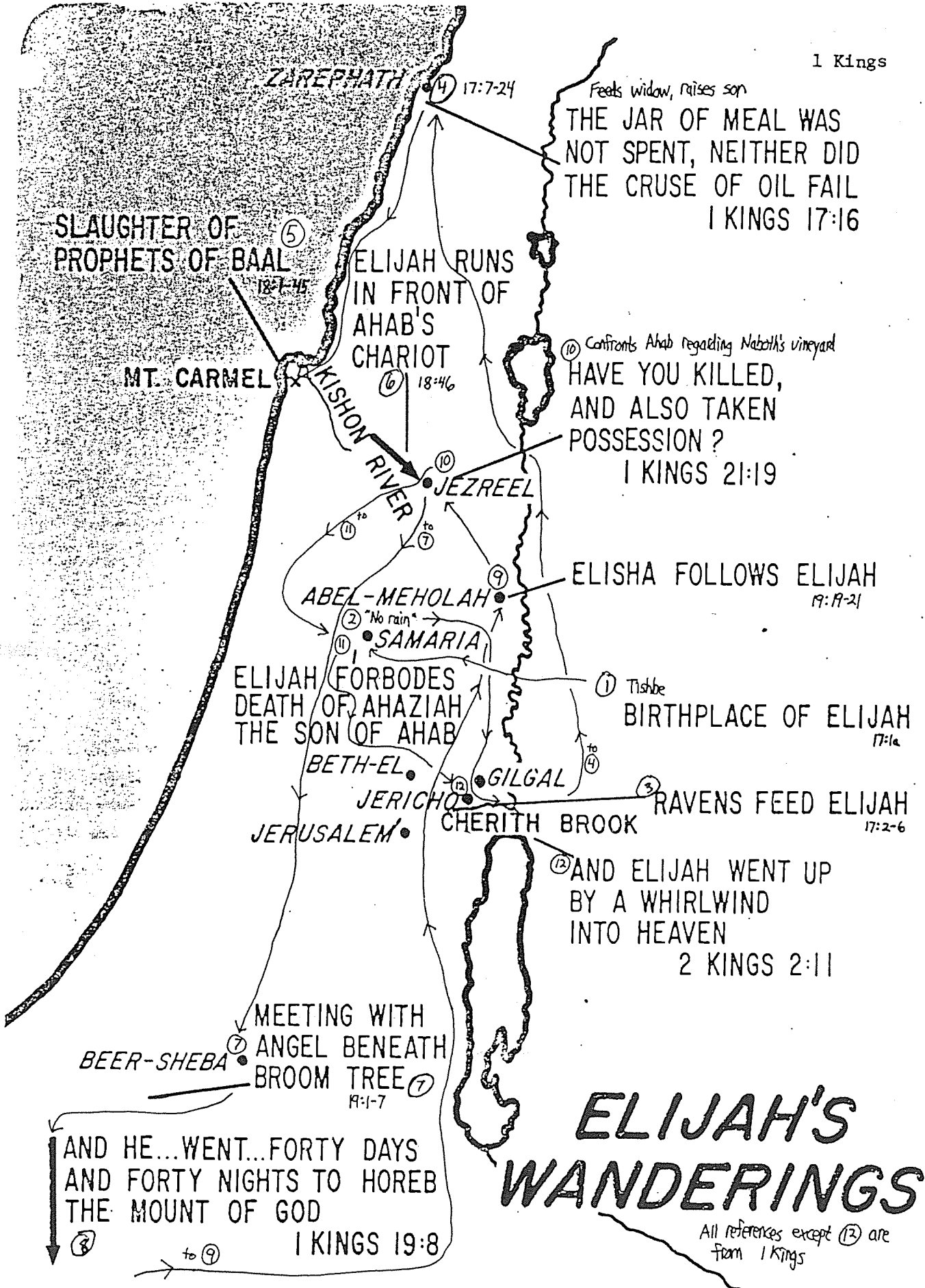

# Solomon's Jerusalem, Elijah and Elisha

The Bible Visual Resource Book, 73

1 Kings

## Solomon's Jerusalem

950 B.C.

Solomon extended the city northward from the original site and there built his magnificent temple.

His royal residence was nearby; however, its architecture and location are unknown.

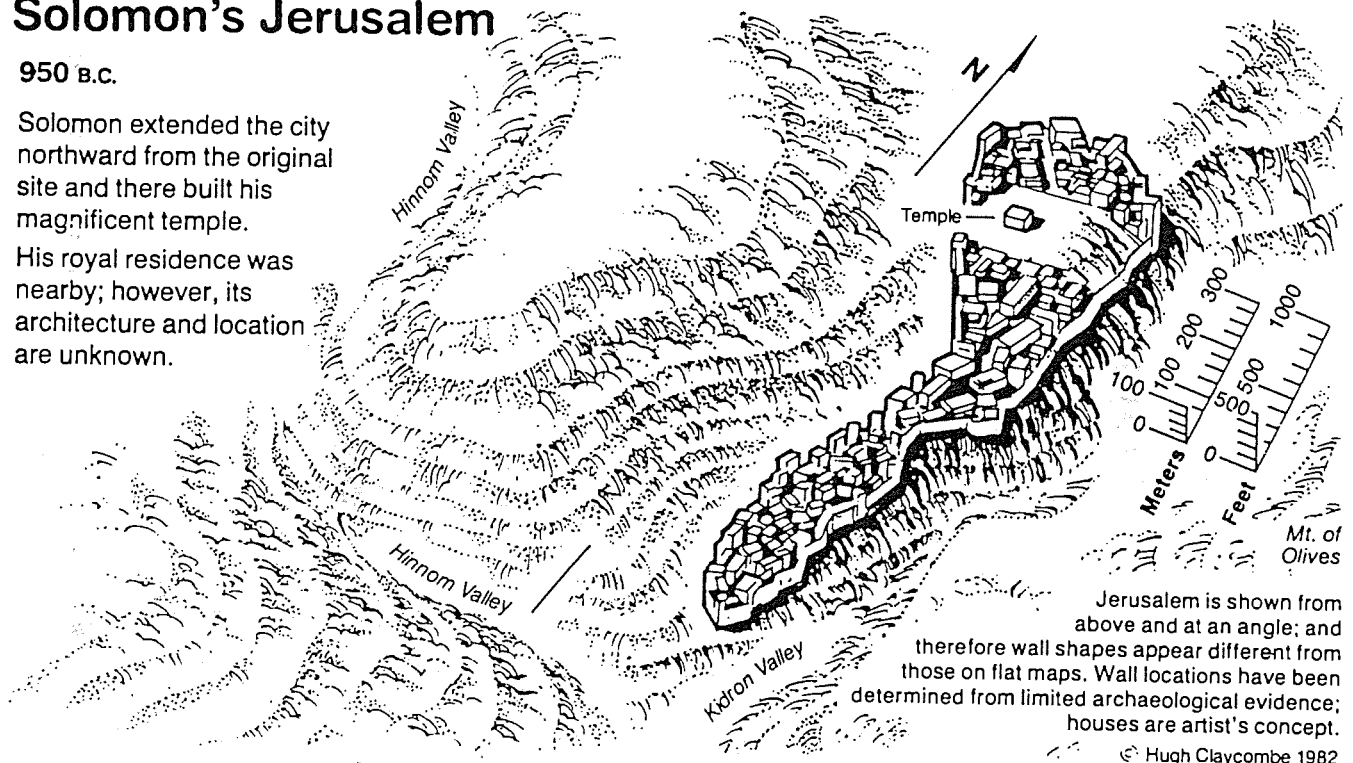

Jerusalem is shown from above and at an angle; and therefore wall shapes appear different from those on flat maps. Wall locations have been determined from limited archaeological evidence; houses are artist's concept.

© Hugh Claycombe 1982

For further reference to the development of Jerusalem see: page 63, *The City of the Jebusites and David's Jerusalem*; page 99, *Jerusalem of the Returning Exiles*; page 139, *Jerusalem During the Time of the Prophets*.

## Elijah

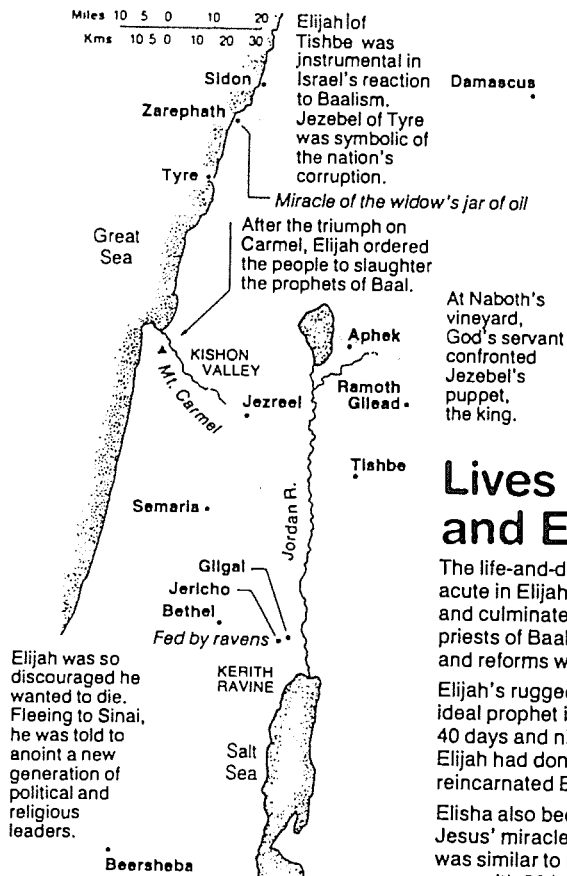

Elijah was so discouraged he wanted to die. Fleeing to Sinai, he was told to anoint a new generation of political and religious leaders.

Beersheba

## Elisha

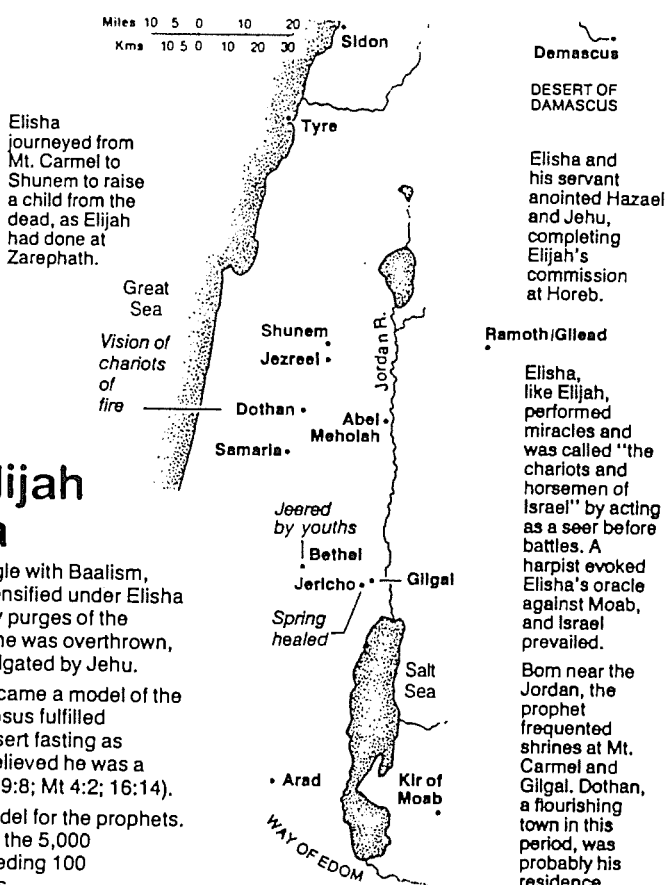

Elisha journeyed from Mt. Carmel to Shunem to raise a child from the dead, as Elijah had done at Zarephath.

Elisha and his servant anointed Hazael and Jehu, completing Elijah's commission at Horeb.

Ramoth/Gilead

Elisha, like Elijah, performed miracles and was called "the chariots and horsemen of Israel" by acting as a seer before battles. A harpist evoked Elisha's oracle against Moab, and Israel prevailed.

Born near the Jordan, the prophet frequented shrines at Mt. Carmel and Gilgal. Dothan, a flourishing town in this period, was probably his residence.

## Lives of Elijah and Elisha

The life-and-death struggle with Baalism, acute in Elijah's day, intensified under Elisha and culminated in bloody purges of the priests of Baal. Ahab's line was overthrown, and reforms were promulgated by Jehu.

Elijah's rugged figure became a model of the ideal prophet in Israel. Jesus fulfilled 40 days and nights of desert fasting as Elijah had done; many believed he was a reincarnated Elijah (1Ki 19:8; Mt 4:2; 16:14).

Elisha also became a model for the prophets. Jesus' miracle of feeding the 5,000 was similar to Elisha's feeding 100 men with 20 barley loaves.

## The Appeal of Idols

*Life Application Bible, 575*

### THE APPEAL OF IDOLS

On the surface, the lives of the kings don't make sense. How could they run to idolatry so fast when they had God's Word (at least some of it), prophets, and the example of David? Here are some of the reasons for the enticement of idols:

#### POWER

#### *The appeal of Idols*

The people wanted freedom from the authority of both God and the priests. They wanted their religion to fit their life-style, not their life-style to fit their religion.

#### *Modern parallel*

People do not want to answer to a greater authority. Instead of having power *over* others, God wants us to have the Holy Spirit's power to *help* others.

#### PLEASURE

Idol worship exalted sensuality without responsibility or guilt. People acted out the vicious and sensuous personalities of the gods they worshiped, thus gaining approval for their degraded lives.

People deify pleasure, seeking it at the expense of everything else. Instead of seeking pleasure that leads to long-range disaster, God calls us to seek the kind of pleasure that leads to long-range rewards.

#### PASSION

Mankind was reduced to little more than animals. The people did not have to be viewed as unique individuals, but could be exploited sexually, politically, and economically.

Like animals, people let physical drives and passion rule them. Instead of seeking passion that exploits others, God calls us to redirect our passions to areas that build others up.

#### PRAISE AND POPULARITY

The high and holy nature of God was replaced by gods who were more a reflection of human nature, thus more culturally suitable to the people. These gods no longer required sacrifice, just a token of appeasement.

Sacrifice is seen as self-inflicted punishment, making no sense. Success is to be sought at all costs. Instead of seeking praise for ourselves, God calls us to praise him and those who honor him.

As societies change, they often throw out norms and values no longer considered necessary or acceptable. Believers must be careful not to follow society's example if it discards God's Word. When society does that, only godlessness and evil remain.

## Contrasting Elijah and Elisha

Huang Sabin, *OT Made Simple* except \* from Leon Wood, *A Survey of Israel's History*  
and # from J. Hampton Keathley III, Biblical Studies foundation (www.Bible.org)

Prophets	Elijah	Elisha
Background*	Poor	Wealthy
Emotional Make-up*	Man of moods—extreme courage & despair	Self-controlled & even-tempered
Kings	Ahab & Ahaziah	Jehoram & Jehu
Nature of Ministry	Mainly public & confrontational with sins of kings	Mainly private & ministering to people's needs
Miracles#	9	14
Duration*	22 years	50 years
Message	Repentance	Deeds of kindness
Mentored by	God?	Elijah
Mentored	Elisha	Gehazi
Memorable Incident	Confrontation with prophets of Baal at Mount Carmel	Judgment upon 42 insulting youths at Bethel

## Kingdom Crossword Puzzle

Adapted from Mr. Ashley Bryant, International Community School, Singapore (undated)

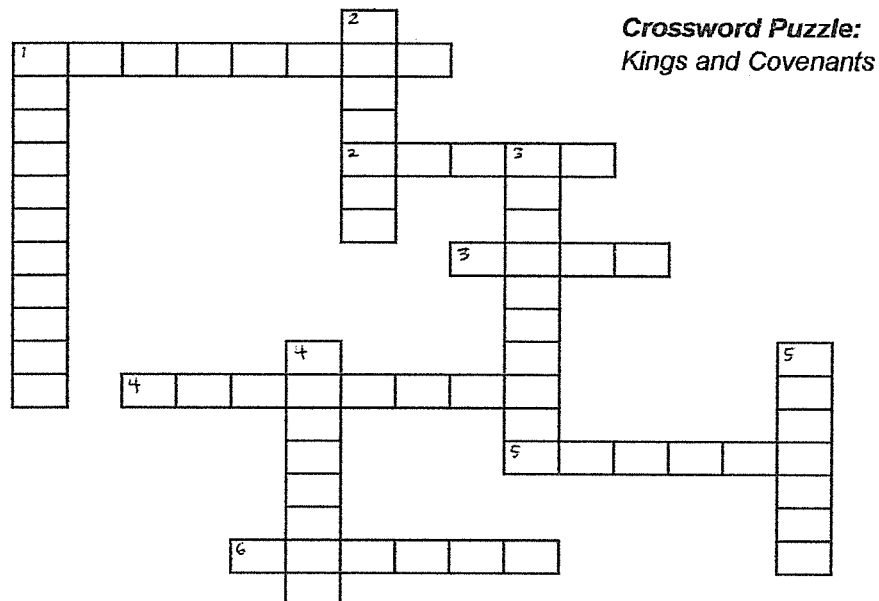

### ACROSS

1. He was the son of Nabat and servant of David, who rebelled against Solomon to establish his own kingdom, which split the kingdom of Israel (1 Kings 12:3-4)
2. This man was God's choice for king over Israel so that God will establish his kingly line forever (1 Sam. 16:13; 2 Sam. 7)
3. He was chosen king by the people because of his stature (1 Sam. 8:19; 10:1)
4. The means by which God establishes a relationship of responsibility between Himself and His people. It is a divine promise.
5. He anointed both Saul and David as king (1 Sam. 10:1; 16:13)
6. God revealed both His promise and his judgment to David through this man (2 Sam. 7:4-7; chapter 12)

### DOWN

1. The King of kings and Lord of lords who descended from the line of David to establish His kingdom forever (2 Sam. 7; 1 Tim. 6:14-15)
2. This is the covenant God established with David promising him that his throne would be established forever (2 Sam. 7:12-16)
3. They wanted a king they could see and touch to rule over them just like the other nations (1 Sam. 8:19)
4. He was the son of Solomon through whom the line from David to Christ would continue (Matt. 1:7; 1 Kings 12:1)
5. He was the son of David through whom God's promise to David would continue (1 Kings 1:30)



## 2 Kings

<b>Downfalls of the Kingdoms</b>					
Late Divided Kingdom			Surviving Kingdom		
Israel and Judah			Judah		
Chapters 1–17			Chapters 18–25		
Israel Exiled to Assyria			Judah Exiled to Babylon		
Ahaziah to Hoshea			Hezekiah to Zedekiah		
130 Years (852-722 BC)			163 Years (722-560 BC)		
2 Bad Israel Kings & Elisha’s Ministry 1:1–8:15	10 Bad Israel Kings & 4 Bad/4 Good Judah Kings 8:16–16:20	Bad Hoshea culminating in Fall of Israel 17	Good Hezekiah & 2 Bad Judah Kings 18–21	Good Josiah & 4 Bad Judah Kings 22:1–24:16	Bad Zedekiah culminating in Fall of Judah & Jerusalem 24:17–25:30

**Key Word:** Downfalls

**Key Verse:** “So the LORD said, “I will remove Judah also from my presence as I removed Israel, and I will reject Jerusalem, the city I chose, and this temple, about which I said, ‘There shall my Name be’” (2 Kings 23:27)

**Summary Statement:**

*The covenant disobedience and resultant downfalls of the kingdoms of Israel and Judah are contrasted with God’s loyalty to the Davidic Covenant to remind Israel of the need to obey the Law—not repeat past mistakes.*

**Application:**

“Don’t rearrange your idols! Remove them!” (Huang Sabin. *OT Made Simple*)

# 2 Kings

## Introduction

Note: This introduction in large part repeats that of 1 Kings except for the Characteristics section.

**I. Title** First and Second Kings originally comprised only one book in the Hebrew canon called "Kings" (מְלָכִים) after the first word in 1:1 ("Now King"; וְהַמֶּלֶךְ). However, this single scroll was arbitrarily divided in the Septuagint (250 BC) since the Greek required a greater amount of scroll space. The Septuagint titles were Third and Fourth Kingdoms (since 1 and 2 Samuel were designated 1 and 2 Kingdoms). Jerome called 1 and 2 Kings "The Book of the Kings" about six centuries later. These titles are appropriate as these books record and interpret the reign of every king of Israel and Judah except Saul (David has brief mention in 1 Kings 1:1—2:12).

## II. Authorship

- A. External Evidence: The talmudic tradition ascribes the authorship of the Books of Kings to Jeremiah, and this gains weight from literary parallels between this record and the prophecy of Jeremiah.
- B. Internal Evidence: The prophetic-like descriptions of Israel's apostasy indicates that the author was a prophet/historian. Also, this compiler had several historical documents at his fingertips: "the book of the acts of Solomon" (1 Kings 11:41), "the book of the chronicles of the kings of Israel" (1 Kings 14:19), and "the book of the chronicles of the kings of Judah" (1 Kings 14:29; 15:7). The existence of these books may be attributed to the official secretary Sheba and/or the official recorder Asaph (2 Kings 18:18). Parallels between 2 Kings 18—20 and Isaiah 36—39 also indicate that Isaiah's scroll undoubtedly was a source. No firm evidence exists to refute the tradition that Jeremiah authored the Book of Kings.

## III. Circumstances

- A. Date: Three lines of evidence indicate that First Kings and even most of Second Kings was written before the Babylonian Captivity (586 BC). The ark still resided in Solomon's temple (1 Kings 8:8), Israel was still in rebellion against Judah (1 Kings 12:19), and Samaria's idolatry persisted even after its resettlement (2 Kings 17:34, 41). However, the final two chapters of Second Kings record up to 26 years after this captivity and may have been recorded by a Jewish captive in Babylon or by Jeremiah himself, who would have been at least 84 years old.

First Kings covers a period of history totaling 120 years, beginning in 971 BC with the inauguration of Solomon and ending in 852 BC with the conclusion of Ahaziah's reign. The year 931 BC marks the most significant date when Solomon's kingdom split into the northern nation of Israel and the southern kingdom of Judah after his death.

Second Kings picks up at 852 BC and traces the account through the falls of Samaria (722 BC) and Jerusalem (586 BC) until the release of Jehoiachin in Babylon in 560 BC (over 293 years).

- B. Recipients: The Book of Kings was written to the remaining kingdom of Judah before (1 Kings 1—2 Kings 23) and after (2 Kings 24—25) its own exile in Babylon.
- C. Occasion: Jeremiah's prophecy and Lamentations record his eyewitness account of Babylon's siege and destruction of Jerusalem for the nation's sins. In addition to his own prophetic word, the Holy Spirit moved him to record an *historical* compilation which provides the context and justification for God's judgments upon these two nations. The leaders and the people sinned through ungodliness and idolatry, and, true to the curses of Deuteronomy 28, God gave the people the consequences of their disobedience. Therefore, the purpose of the record is to demonstrate how the welfare of Israel and Judah depended upon the faithfulness of the king and people to the covenant of Moses to teach the exiles to learn from the past mistakes of their ancestors. In large part this purpose was accomplished in history as Israel has not since the Captivity had a problem with idolatry.

#### IV. Characteristics

A. Some contrasts between the two books of Kings may prove helpful:

	<u>1 Kings</u>	<u>2 Kings</u>
Dates	971-852 BC	852-560 BC
Length	120 years	Over 293 years
Kings	David-Ahaziah	Ahaziah-Zedekiah
# of Chapters	22	25
General Content	Division of the Kingdom	Downfall of the Kingdoms
Major Judgments	Divided Kingdom (931 BC)	Israel (722 BC), Judah (586 BC)
Temple	Built and consecrated	Violated and destroyed (380 yrs. later)
Beginning/end	Begins with blessings for obedience	Ends with judgment for disobedience

B. Second Kings depicts the reigns of more kings than any book in Scripture.

### Argument

Second Kings continues the account from First Kings since they originally composed a single work. Therefore, the book presents the same ethical argument—to convince the readers from the lessons of the past that God blesses obedience to His covenant but judges disobedience. This is observable in the account of the kings of both Israel and Judah before the fall of Assyria (chs. 1—17) and the kings of Judah before its own fall (chs. 18—25). The book also shows God's merciful commitment to the Davidic Covenant through the kings of Judah who constitute only a single dynasty in contrast to the five dynasties of the northern kingdom which does not possess the promise of the Davidic Covenant. Therefore, while God punishes rebellion He nevertheless is faithful to the covenant He made with David.

### Synthesis

#### Later divided kingdom covenant disobedience Downfalls of the Kingdoms

1—17

	Later divided kingdom (good kings in bold print)
1	Ahaziah (I)
2:1—8:15	Joram (I) vs. <u>Elisha</u>
2	Succession of Elijah
3	Water for [Joram, Jehoshaphat, king of Edom] vs. Moab
4:1-7	Oil for widow
4:8-17	Son for Shunammite
4:18-37	Restoration for Son
4:38-41	Stew for prophets
4:42-44	Bread for men
5	Healing for Naaman
6:1-7	Axhead for seminarians
6:8-23	Blinding of Syrians
6:24—7:20	Food of Syrians
8:1-6	Guidance for Shunammite
8:7-15	Prophecy of Hazael's succeeding Ben-Hadad
8:16-24	Jehoram (J)
8:25—9:29	Ahaziah (J)
9:30—10:36	Jehu (5; I)
11	Athaliah (J)
12	<b>Joash (J)</b>

#### Key:

Good kings are in **bold print**  
 I = Israel's kings  
 J = Judah's kings  
 5 = Numbers show new dynasties in Israel (Judah is one dynasty)

13:1-9	Jehoahaz (I)
13:10-25	Jehoash (I)
<b>14:1-22</b>	<b>Amaziah (J)</b>
14:23-29	Jeroboam II (I)
<b>15:1-7</b>	<b>Azariah (Uzziah; J)</b>
15:8-12	Zechariah (I)
15:13-16	Shallum (6; I)
15:17-22	Menahem (7; I)
15:23-26	Pekahiah (8; I)
15:27-31	Pekah (I)
<b>15:32-38</b>	<b>Jotham (J)</b>
16	Ahaz (J)
17:1-6	Hoshea (9; I)
17:7-23	Captivity reasons
17:24-41	Resettlement
<b>18—25</b>	<b>Surviving kingdom (all Judah)</b>
<b>18—20</b>	<b>Hezekiah</b>
18:1-8	Destroys paganism
18:9-12	Rabshakeh ridicules
19	185,000 killed
20:1-11	Sickness and sun
20:12-21	Babylonian messengers
21:1-18	Manasseh
21:19-26	Amon
<b>22:1—23:30</b>	<b>Josiah</b>
23:31-34	Jehoahaz
23:35—24:7	Jehoiakim 605 BC Deportation #1
24:8-16	Jehoiachin 597 BC Deportation #2
24:17—25:21	Zedekiah 586 BC Deportation #3
25:22-26	Governor Gedaliah
25:27-30	Jehoiachin released



## Outline

### Summary Statement for the Book

The *covenant disobedience and resultant downfalls* of the kingdoms of Israel and Judah are contrasted with *God's loyalty to the Davidic Covenant* to remind Israel of the need to obey the Law—not repeat past mistakes.

- I. (Chs. 1—17) The covenant disobedience of the divided later kingdoms of Israel and Judah is judged in the Assyrian Captivity to remind Israel to obey the Law—not repeat the past (852-722 BC).
  - A. (Ch. 1) The rest of Ahaziah's evil reign in Israel (Fourth Dynasty) chronicles Elijah's fulfilled prophecy of his death after the fire-deaths of 102 men because Ahaziah consults Baal-Zebub, god of Ekron, rather than the LORD—teaching God's sovereignty over all gods.
  - B. (2:1—8:15) Joram's evil reign in Israel with idol worship is contested by Elisha, who miraculously demonstrates God's sovereignty over Baal to show Israel that the nation should trust in the LORD alone.
    1. (Ch. 2) Elisha succeeds Elijah as prophet after his master ascends into heaven, then miraculously heals water and kills 42 mocking teenagers as signs of his prophetic authority.
    2. (Ch. 3) Elisha miraculously provides water for the wicked Joram of Israel and good Jehoshaphat of Judah to defeat Moab as a sign of God's sovereignty over Baal, god of rain.

3. (4:1-7) Elisha miraculously provides oil for a prophet's widow to pay her debts to demonstrate God's care for those who trust Him despite the apostasy around them.
  4. (4:8-17) Elisha miraculously enables a Shunammite woman to bear a son as a polemic against Baal, god of fertility.
  5. (4:18-37) Elisha miraculously restores the Shunammite's boy to life years later to demonstrate God's sovereignty over Baal, to whom child sacrifice was offered in Israel.
  5. (4:38-41) Elisha miraculously removes the poison of a deadly stew during a famine to demonstrate God's sovereignty over Baal, god of vegetation, and warn of the deadly effects of Baalism despite its apparent harmlessness.
  6. (4:42-44) Elisha miraculously multiplies twenty loaves of bread to feed one hundred men (prophets?) during the famine as an indication of God's sovereignty over Baal, god of fertility known as "lord of the earth" but without such power.
  7. (Ch. 5) Elisha miraculously transfers the leprosy of the faithful, thankful, foreign Naaman to the unfaithful, greedy, prejudiced, Israelite Gehazi as indication of God's international concern and sovereignty over Baal's supposed power to heal.
  8. (6:1-7) Elisha miraculously makes an iron axhead float to encourage his group of seminarians building a new dorm that they are serving the LORD who will provide all their needs in contrast to Baal, who can meet no needs at all.
  9. (6:8-23) Elisha miraculously opens his servant's eyes to God's protective chariots then leads the blinded raiding Syrians to Joram, who by hospitality temporarily binds them to peace, thus showing God's protective hand through a prophet—not warriors.
  10. (6:24—7:20) Elisha miraculously prophesies the deliverance of Samaria from a Syrian famine siege and God answers with food from the Syrian camp after the army flees in fright to convince Israel that God provides food and protection, not Baal.
  11. (8:1-6) Elisha miraculously tells the Shunammite how long to sojourn from her land during a famine which God confirms through Gehazi's preparation of Joram so that she is granted her house, land, and income to testify of God's provision for the righteous.
  12. (8:7-15) Elisha miraculously prophesies of God's discipline of Israel through Hazael's cruelty after succeeding Ben-Hadad as king of Aram, then Hazael impatiently seizes the crown by murdering Ben-Hadad while making it look like a natural death (cf. 1 Kings 19:15).
- C. (8:16-24) Jehoram's evil reign in Judah due to his marriage to a daughter of Ahab sees victory over Edom and the sparing of Jehoram's life because of God's commitment to the Davidic Covenant.
- D. (8:25—9:29) Ahaziah's evil reign in Judah due to being a grandson of Ahab sees the divine anointing of Jehu of Israel who slays Azariah and Joram for Joram's father Ahab's murder of Naboth, thus ending the fourth dynasty as God's judgment for wickedness (cf. p. 238).
- E. (9:30—10:36) Jehu's evil reign in Israel (Fifth Dynasty) allows the golden calf worship to continue but deceitfully purges the nation of Jezebel, the entire family of Ahab, and all Baal worship to demonstrate God's sovereignty over Baal.
- F. (Ch. 11) Athaliah's evil reign in Judah destroys the entire royal family except her one year old grandson Joash, who six years later is crowned by Jehoiada the priest while Athaliah is executed to demonstrate God's protection of the Davidic line.
- G. (Ch. 12) Joash's good reign in Judah until his assassination by his servants does not remove the high places but does repair the temple and begins a righteous rule by four Judean kings lasting 105 years.

- H. (13:1-9) Jehoahaz's evil reign in Israel is judged by the complete dominance of Hazael and his son Ben-Hadad II of Aram to show God's judgment for idolatry.
- I. (13:10-25) Jehoash's evil reign in Israel experiences only three victories over Aram (as Elisha predicted before his death) rather than a complete destruction to warn of the dangers of disbelief in God.
- J. (14:1-22) Amaziah's good reign in Judah does not remove the high places but executes his father's murderers and defeats Edom, then is himself defeated after picking a fight with Jehoash of Israel.
- K. (14:23-29) Jeroboam II's evil reign in Israel restores Israel's boundaries in fulfillment of Jonah's prophecy and sees the nation spared from intense suffering because of God's promise not to blot out Israel.
- L. (15:1-7) Azariah's (Uzziah) good reign in Judah lasts 52 years but does not remove the high places and Azariah lives in a separate house due to his leprosy (cf. 2 Chron. 26).
- M. (15:8-12) Zechariah's evil reign in Israel due to idolatry ends abruptly when Shallum son of Jabesh publicly assassinates him and succeeds him as king to show the fulfillment of God's word that Jehu's house would last only until the fourth (Zechariah's) generation.
- N. (15:13-16) Shallum's evil reign in Israel (Sixth Dynasty) lasts only one month until his assassination by Menahem son of Gadi as God's punishment on his wickedness.
- O. (15:17-22) Menahem's evil reign in Israel (Seventh Dynasty) brings tribute to Pul (Tiglath-Pileser) of Assyria as God's judgment for his idolatry.
- P. (15:23-26) Pekahiah's evil reign in Israel ends his dynasty by assassination from Pekah, son of Remaliah, as God's judgment upon his sin of idolatry.
- Q. (15:27-31) Pekah's evil reign in Israel (Eighth Dynasty) is judged by Tiglath-Pileser's second invasion—this time taking cities and deporting Israelites—and by assassination from Hoshea son of Elah in return for Pekah's idolatry.
- R. (15:32-38) Jotham's good reign in Judah rebuilds the Upper Gate of the temple but does not remove the high places and begins to receive judgment from Pekah of Israel and Rezin of Aram in anticipation of Ahaz's evil reign.
- S. (Ch. 16) Ahaz's evil reign in Judah breaks the 105 consecutive years of good Judean kings by sacrificing his own son, constructing and worshipping at the high places, and appealing to Tiglath-Pileser rather than God for protection from Pekah and Rezin.
- T. (17:1-6) Hosea's evil reign in Israel (Ninth Dynasty) appeals to So of Egypt rather than paying tribute to Shalmaneser of Assyria, so he repays Hosea's treachery by a third and final Assyrian invasion and deportation of the Israelites (722 BC).
- U. (17:7-23) The reason for Israel's captivity to Assyria is detailed as having rejected the Law of God for idols, sacred stones, high places, Asherah poles, astrology, divination, sorcery and other practices of the nations, listed to vindicate God's judgment.
- V. (17:24-41) Samaria is resettled by other conquered pagan peoples who, despite the teaching of a priest of Yahweh, engage themselves in syncretistic practices which incorporate both Yahweh worship and their national deities.
- II. (Chs. 18–25) The covenant disobedience of the surviving later kingdom of Judah is judged in the Babylonian Captivity to remind Israel to obey the Law— not repeat past mistakes (722-560 BC) .**

- A. (Chs. 18—20) **Hezekiah's** good reign is unexcelled by any king in his devotion to the LORD but his foolish reliance upon the Babylonian messengers results in the nation eventually being taken into exile to instruct in the need to trust God alone.

(Note: Isaiah 36—39 records this account nearly verbatim).

1. (18:1-8) Hezekiah's good reign excels that of any king of Judah before or after him in that he destroys all forms of pagan worship and serves the LORD wholeheartedly.
  2. (18:9-12; cf. Isa. 36) In Hezekiah's fourteenth year Sennacherib's Assyrian army commander (Rabshakeh) ridicules the God of Judah as he threatens to conquer Jerusalem if the people do not surrender.
  3. (Ch. 19; cf. Isa. 37) Hezekiah responds in faith by bringing the matter to God and the angel of the LORD responds by killing 185,000 Assyrian soldiers as well as Rabshakeh, thus demonstrating God's sovereignty over the Assyrian and local gods.
  4. (20:1-11; cf. Isa. 38) Hezekiah's sickness and miraculous fifteen year lease on life demonstrates God's sovereignty even over death and the movements of the sun, let alone the nation of Assyria.
  5. (20:12-21; cf. Isa. 39) Hezekiah's foolish reliance upon the Babylonian messengers results in the nation eventually being taken into exile after Hezekiah's death to instruct in the need to trust God alone.
- B. (21:1-18) Manasseh's evil reign of 55 years (the longest of any king) reinstates all the pagan practices destroyed by Hezekiah his father which vindicates God's soon punishment of Babylonian exile for the nation.
- C. (21:19-26) Amon's evil reign repeats Manasseh's mistakes until he is assassinated by his officials, who are themselves assassinated by the people, who place Amon's son Josiah on the throne.

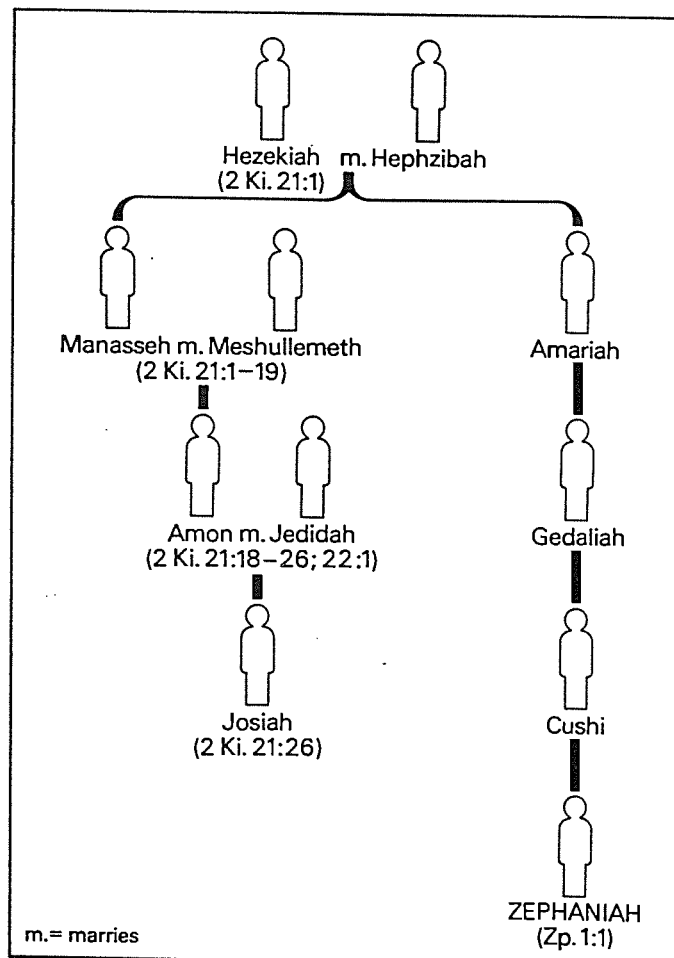

Source: Charles Pfeiffer, "Zephaniah," *New Bible Dictionary*, 2<sup>nd</sup> ed., p. 1279

- D. (22:1–23:30) **Josiah's** good reign recovers the Book of the Law (Deuteronomy?) during temple repairs which motivates him to renew the Mosaic Covenant for the people and desecrate all pagan altars built by his grandfather Manasseh.
- E. (23:31-34) Jehoahaz's evil reign ends in subjugation to Pharaoh Neco after only three months followed by exile and death in Egypt while his brother Jehoiakim (Eliakim before Pharaoh changes his name) replaces him.
- F. (23:35–24:7) Jehoiakim's evil reign results in subjugation to Pharaoh Neco of Egypt and to Nebuchadnezzar of Babylon [who deports some citizens such as Daniel; cf. Dan. 1:1-7 in 605 BC], as well as subjugation to raiders from Babylon, Aram, Moab, and Ammon.
- G. (24:8-16) Jehoiachin's evil reign surrenders during Nebuchadnezzar's second invasion (597 BC) in which he sieges Jerusalem and takes the temple treasures and 10,000 wealthier people as plunder, including Jehoiachin [and Ezekiel].
- H. (24:17–25:21) Zedekiah's evil reign results in Nebuchadnezzar's third and final siege (586 BC) which destroys Solomon's temple, the palace, every important building, and most of the people as God's judgment for their idolatry.
- I. (25:22-26) The Babylonian government appointee Gedaliah is assassinated by Ishmael of Nethaniah who is of royal blood, but he flees to Egypt and never reigns himself to teach the folly of seeking to seize God's blessing since He has suspended the rule of Davidic kings.
- J. (25:27-30) Jehoiachin is released from his Babylonian prison in 560 BC and eats at the king's table until his death as a foreshadowing of God's mercy towards the nation by protecting the Davidic dynasty and restoring His people to their land.

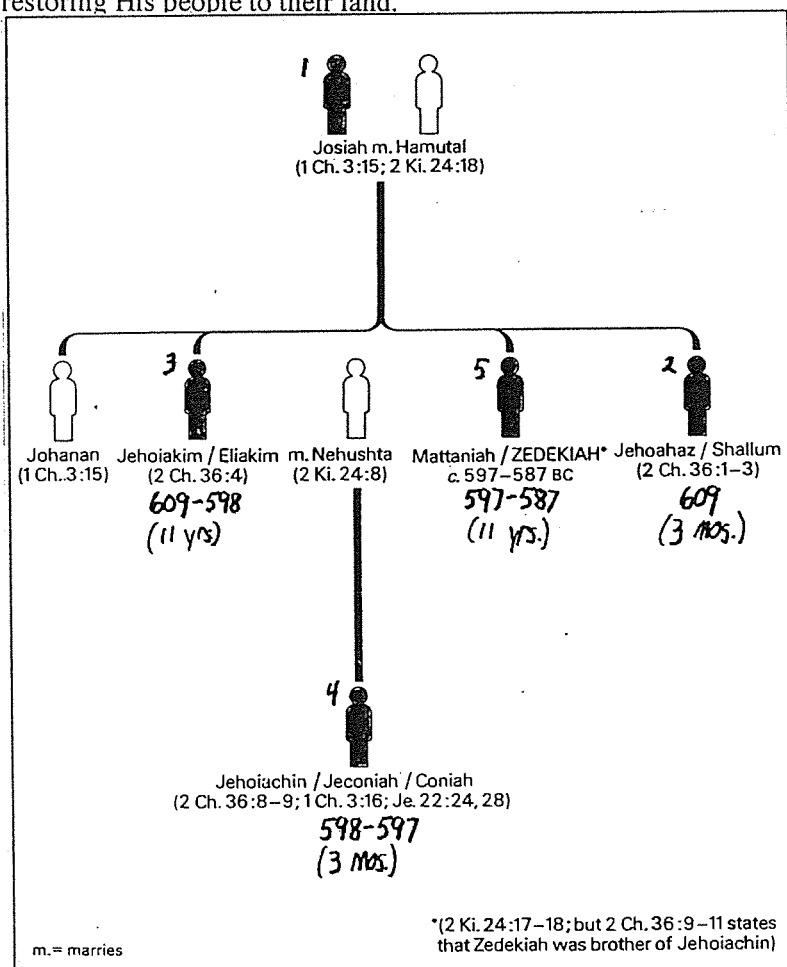

An interpretation of Zedekiah's family tree.

D. W. Baker, "Zedekiah," *New Bible Dictionary*, 2<sup>nd</sup> ed., p. 1277



## Assyrian Foreign Policy

John H. Walton, *Chronological and Background Charts of the OT*, 2d ed., 66

<p>STAGE I</p>	<p style="text-align: center;">Vassal relationship</p> <p>Vassal committed to:</p> <ul style="list-style-type: none"> <li>— Annual payment of tribute</li> <li>— Furnishing of auxiliary troops</li> </ul>
<p>STAGE II</p>	<p style="text-align: center;">If vassal was involved in Anti-Assyrian conspiracy</p> <ul style="list-style-type: none"> <li>— Appointment of new ruler (from native royal house if representative loyal to Assyria could be found)</li> <li>— Territorial reductions (areas taken away were either given to loyal neighboring vassals or made into Assyrian provinces)</li> <li>— Deportations of parts of the upper class</li> <li>— Increased tribute and military presence</li> </ul>
<p>STAGE III</p>	<p style="text-align: center;">If further Anti-Assyrian activity were even suspected</p> <ul style="list-style-type: none"> <li>— Vassal ruler removed</li> <li>— Political independence revoked</li> <li>— Territory made into Assyrian province with Assyrian governor and officials</li> <li>— Deportation of upper class; replaced with foreign upper class</li> </ul>

# Assyrian Campaigns against Israel and Judah

The Assyrian invasions of the eighth century B.C. were the most traumatic political events in the entire history of Israel.

The brutal Assyrian style of warfare relied on massive armies, superbly equipped with the world's first great siege machines manipulated by an efficient corps of engineers.

Psychological terror, however, was Assyria's most effective weapon. It was ruthlessly applied, with

corpses impaled on stakes, severed heads stacked in heaps, and captives skinned alive.

The shock of bloody military sieges on both Israel and Judah was profound. The prophets did not fail to scream out against their horror, while at the same time pleading with the people to see God's hand in history, to recognize spiritual causes in the present punishment.

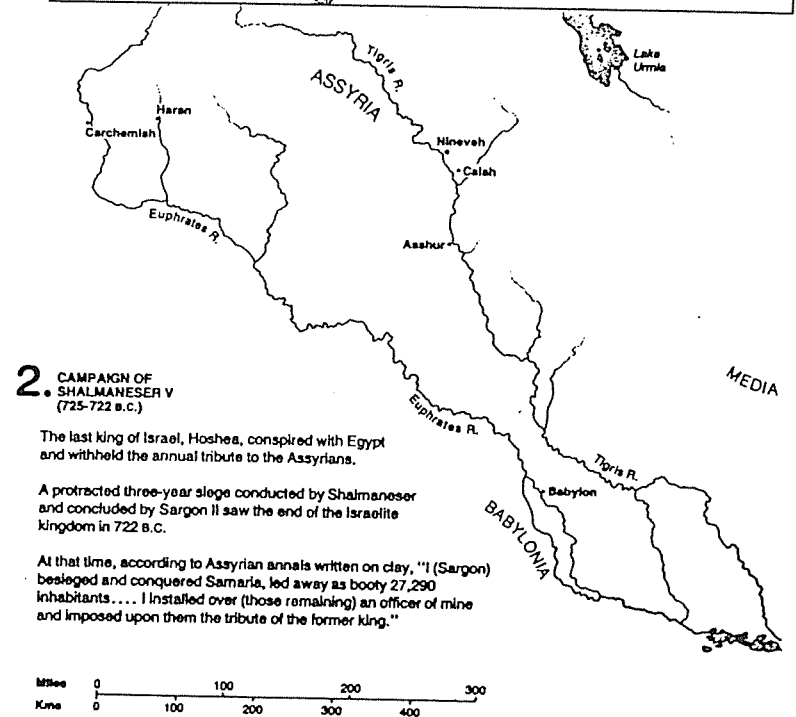
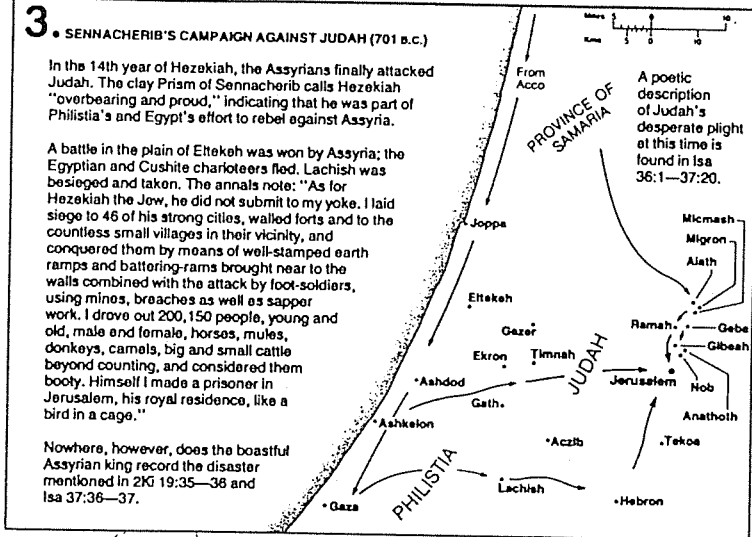
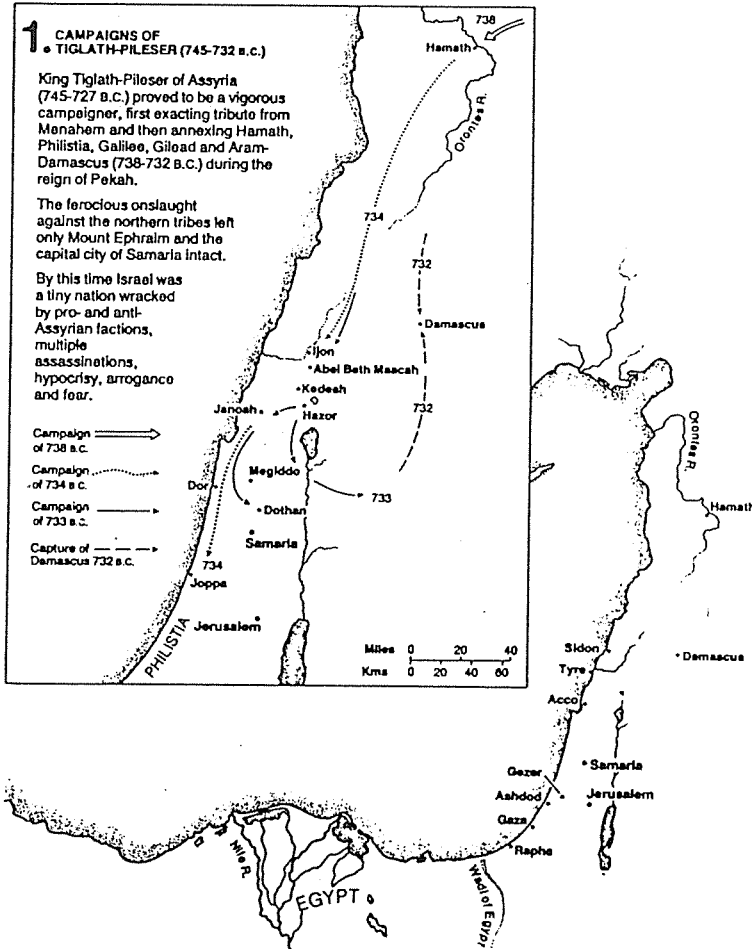

**Assyrian Campaigns Against Israel and Judah**  
*The Bible Visual Resource Book, 79*

# Exile of the Northern Kingdom

*The Bible Visual Resource Book, 81*

2 Kings

## Exile of Northern Kingdom



The mass deportation policy of the Assyrians was a companion piece to the brutal and calculated terror initiated by Ashurnasirpal and followed by all his successors. It was intended to forestall revolts but, like all Draconian measures, it merely spread misery and engendered hatred. In the end, it hastened the disintegration of the Assyrian empire.

There is some evidence that Israel experienced its first deportations under Tiglath-Pileser III (745-727 B.C.), a cruelty repeated by Sargon II (722-705 B.C.) at the time of the fall of Samaria. The latter king's inscriptions boast of carrying away 27,290 inhabitants of the city "as booty." According to 2Ki 17:6, they were sent to Assyria, to Halah (Calah?), to Gozan on the Habor River, and apparently to the eastern frontiers of the empire (to the towns of the Medes, most probably somewhere in the vicinity of Ecbatana, the modern Hamadan).

The sequel is provided by the inscriptions of Sargon: "The Arabs who live far away in the desert, who know neither overseers nor officials, and who had not yet brought their tribute to any king, I deported... and settled them in Samaria."

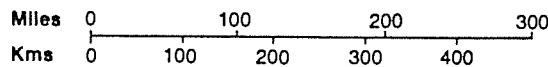

Much mythology has developed around the theme of the so-called ten lost tribes of Israel. A close examination of Assyrian records reveals that the deportations approximated only a limited percentage of the population, usually consisting of noble families. Agricultural workers, no doubt the majority, were deliberately left to care for the crops (cf. the Babylonian practice, 2Ki 24:14; 25:12).

# Nebuchadnezzar's Campaign against Judah

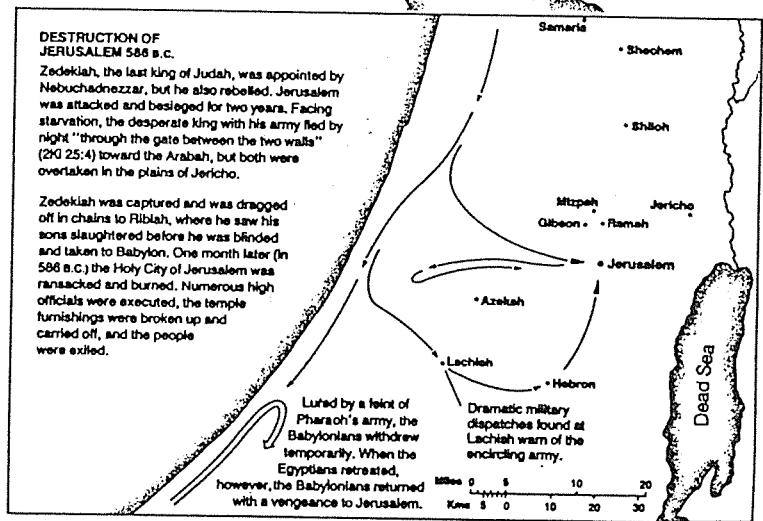
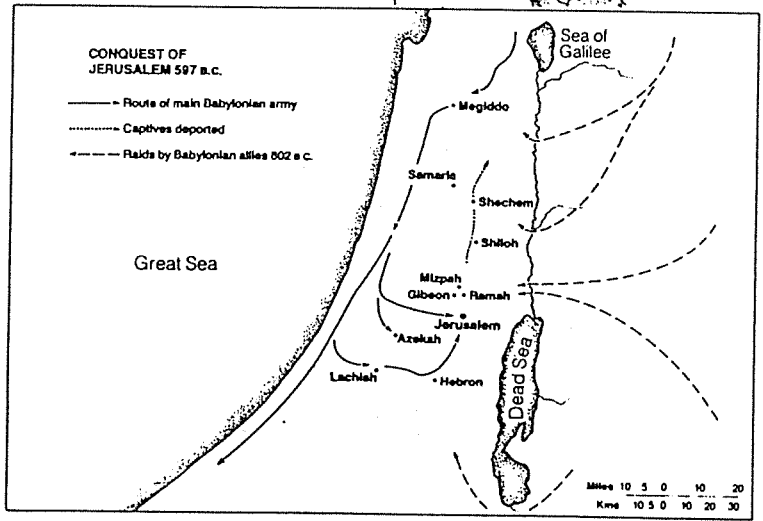
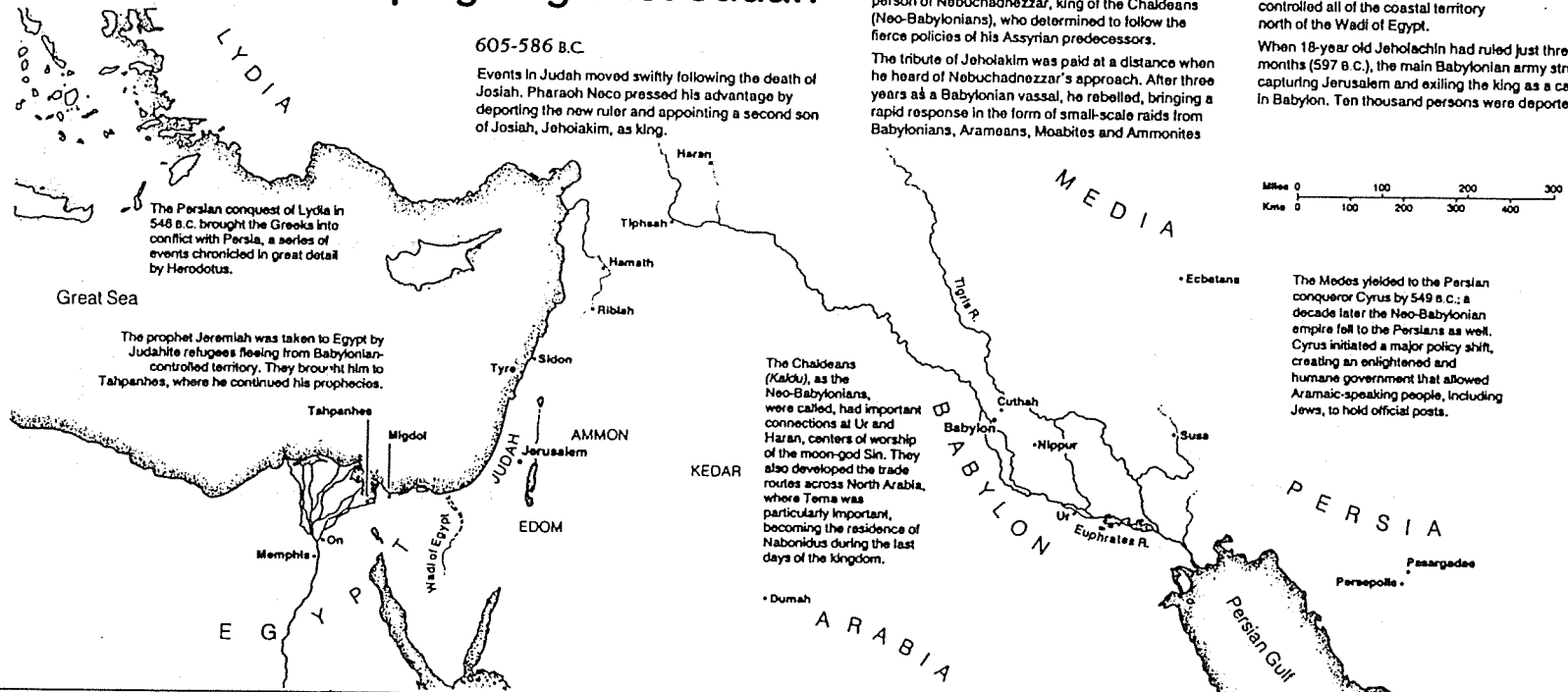

**Exile of the Southern Kingdom**  
*The Bible Visual Resource Book, 84*

**Exile of the Southern Kingdom**

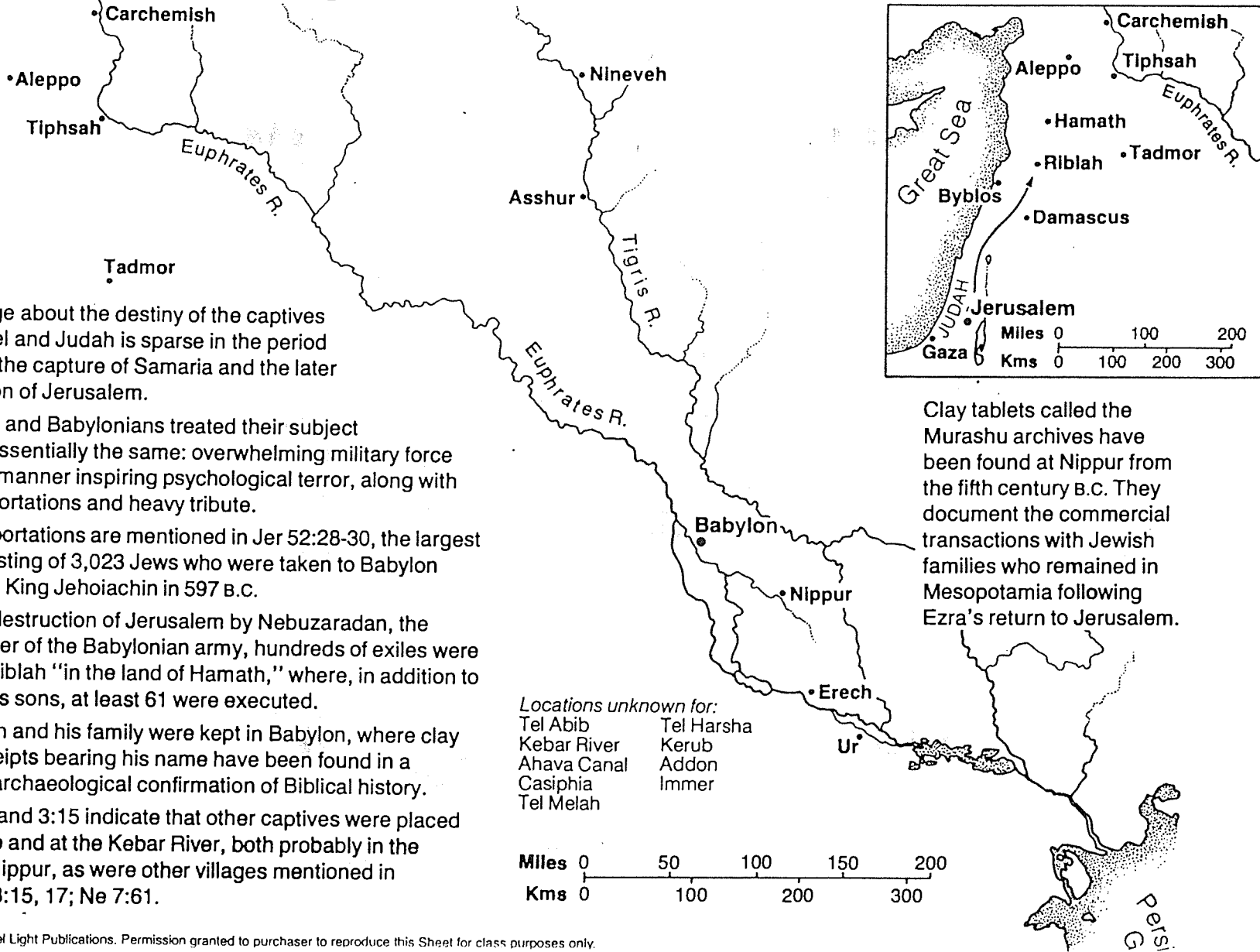

Knowledge about the destiny of the captives from Israel and Judah is sparse in the period following the capture of Samaria and the later destruction of Jerusalem.

Assyrians and Babylonians treated their subject peoples essentially the same: overwhelming military force used in a manner inspiring psychological terror, along with mass deportations and heavy tribute.

Three deportations are mentioned in Jer 52:28-30, the largest one consisting of 3,023 Jews who were taken to Babylon along with King Jehoiachin in 597 B.C.

After the destruction of Jerusalem by Nebuzaradan, the commander of the Babylonian army, hundreds of exiles were taken to Riblah "in the land of Hamath," where, in addition to Zedekiah's sons, at least 61 were executed.

Jehoiachin and his family were kept in Babylon, where clay ration receipts bearing his name have been found in a dramatic archaeological confirmation of Biblical history.

Eze 1:1-3 and 3:15 indicate that other captives were placed at Tel Abib and at the Kebar River, both probably in the locale of Nippur, as were other villages mentioned in Ezr 2:59; 8:15, 17; Ne 7:61.

Clay tablets called the Murashu archives have been found at Nippur from the fifth century B.C. They document the commercial transactions with Jewish families who remained in Mesopotamia following Ezra's return to Jerusalem.

*Locations unknown for:*  
 Tel Abib      Tel Harsha  
 Kebar River      Kerub  
 Ahava Canal      Addon  
 Casiphia      Immer  
 Tel Melah

# 1 Chronicles

David's Line Established							
David's Line				David's Concern (Ark/Temple)			
Chapters 1-9				Chapters 10-29			
Genealogy				History			
Ancestry				Activity			
Saul's Throne to David				David's Throne to Solomon			
4143-1011 BC (3132 years)				1011-971 BC (40 years)			
Davidic Line 1-3	Tribal Lines 4-8	Priests/ Levites 9:1-34	Saul's Line 9:35-44	Accession to Throne 10-12	Respect for Ark 13-17	Military Victories 18-20	Temple Prep. 21-29

**Key Word:** Establishment

**Key Verse:** "I declare that the LORD will build a house for you: When your days are over and you go to be with your fathers, I will raise up your offspring to succeed you, one of your own sons, and I will establish his kingdom. He is the one who will build a house for me, and I will establish his throne forever. I will be his father, and he will be my son. I will never take my love away from him, as I took it away from your predecessor. I will set him over my house and my kingdom forever; his throne will be established forever" (1 Chron. 17:10b-14).

**Summary Statement:**

The spiritual perspective on the establishment of David's kingdom is given to encourage the remnant with God's *preservation of the Davidic line* and to admonish them to *proper temple worship*—not the idolatry of the past.

**Applications:**

Trust in God's unconditional promises.

Worship God in His way—not your own.

Ask God to enable you to see history and world events from His divine perspective.

# 1 Chronicles

## Introduction

I. **Title** As was true for the Books of Samuel and Kings, so the Books of Chronicles originally comprised a single scroll. The Hebrew name (דְּבָרֵי הַיָּמִים *Dib<sup>e</sup>re Hayyamim*) translates "The Words (Accounts, Events) of the Days," which in modern idiom means "The Events of the Times." The book was divided in the Septuagint with the name *Paraleipomenon*, "Of Things Omitted," referring to data lacking in Samuel and Kings. However, this title wrongly implies that Chronicles merely supplies omissions in Kings, which does not explain the parallel accounts and different emphases. The English title "Chronicles" is perhaps best. It stems from Jerome's Latin Vulgate (ca. AD 395) as he felt it chronicles the entire sacred history.

## II. Authorship

- A. **External Evidence:** The Talmud maintains that Ezra the priest authored the work, while some Talmudists believe that Nehemiah completed the genealogical tables (1 Chron. 1—9).
- B. **Internal Evidence:** The content verifies the external tradition in that the book emphasizes the temple, the priesthood, and the theocratic line of David in the kingdom of Judah. The style is very similar to the Book of Ezra, and both share a priestly perspective: genealogies, temple worship, ministry of the priesthood, and obedience to the Law (*TTTB*, 100). Ezra's authorship is especially supported by the fact that Ezra 1:1-3 repeats the closing verses of 2 Chronicles 36:22-23 almost identically.

## III. Circumstances

- A. **Date:** The references to the deportation of Judah (1 Chron. 6:15; 9:1) make it clear that the work was compiled after 586 BC, but another key passage shows the books were compiled after the return from Babylon. This passage (1 Chron. 3:17-24) reveals that the latest person recorded in Chronicles is Anani (v. 24) of the eighth generation from Jehoiachin (v. 17), who was taken captive to Babylon in 598 BC. Assuming 25 years for each of these eight generations places Anani's birth ca. 425 to 400 BC. However, Ezra authored the work and his ministry in Scripture does not stretch beyond ca. 445 (cf. Neh. 12:36). Therefore, the best estimate of the time of the compilation is between about 450-425 BC. The record of the Return (2 Chron. 36:22-23) also argues for a postexilic date.
- B. **Recipients:** Using the above date of 450-425 BC for compilation, the original readers comprised Jews who had been back in the land for about a century and probably had recently experienced the reconstruction of the Jerusalem walls under Nehemiah.
- C. **Occasion:** The Book of Kings (covering about the same period as Chronicles) had been written a century earlier (ca. 550 BC) and would certainly have been deposited in Jerusalem. With the availability of Kings one can wonder why Ezra saw a need to re-write the nation's history in the Chronicles. The answer lies in his focus on the temple, designed to prevent the people from ever returning to the high places. Thus Kings records the history from a political/ethical standpoint, but Chronicles provides the spiritual/priestly perspective. It reminded the people that David's royal line still remained to encourage the small remnant who had returned and built a meager temple compared to Solomon's (cf. Hag. 2:3). Thus Chronicles was recorded to bolster the hopes of those who saw only a vague reminiscence of the glory of former days.

## IV. Characteristics

- A. "All the books of the Bible, thus far, from Genesis to II Kings have pursued a chronological succession of events, right from Adam's creation to Judah's captivity; but now with the Chronicles we come to a writing which does not carry us forward . . . but goes back and reviews the whole story in order to derive and apply a vital lesson, namely, that *the nation's response to God is the decisive factor in its history and destiny*" (J. Sidlow Baxter, 2:179). Technically, 2 Chronicles 36:21-23 does carry the account forward, but these three verses cover only 48 more years to the return from exile under Cyrus.

B. Chronicles covers the same period of Jewish history begun in 2 Samuel (=1 Chron.) and stretches past 2 Kings (= 2 Chron.). This kingdom period charted appears as such:

	1 Chronicles		2 Chronicles					
<i>Books</i>	1 Samuel	2 Samuel	1 Kings	2 Kings				
<i>Kings</i>	Saul	David	Solomon- Ahaziah	Ahaziah- Zedekiah				
<i>Dates</i>	1043	1011	971	852	852	722	586	560 538
<i>Kingdom</i>	-----United-----		-----Divided-----		-Surviving-		-Returned-	

C. By way of review (this section repeated from 1 Kings notes, p. 221), while the Books of Kings and Chronicles overlap in their records of the kingdom period, some notable differences in emphases can be cited (Constable, *BKC*, 1:484; Merrill, *BKC*, 1:591; Zuck, *BTOT*, 162):

	<b>Kings</b>	<b>Chronicles</b>
<b>Kings of...</b>	Israel and Judah	Judah (almost exclusively)
<b>Elements</b>	Royal/prophetic	Priestly (temple and worship)
<b>Evaluation</b>	Based on Mosaic Law	Based on David/worship of Yahweh
<b>Purpose</b>	Ethical: Judging both nations	Covenant: Blessing Judah due to David
<b>Author</b>	Jeremiah the prophet/priest	Ezra the priest
<b>Faith</b>	Man's faithlessness	God's faithfulness
<b>Outlook</b>	Negative: rebellion/tragedy	Positive: hope amidst apostasy/tragedy
<b>Recipients</b>	Exilic Jews (ca. 550 BC)	Postexilic Jews (ca. 440 BC)
<b>Chronology</b>	971-586 BC	1011-538 BC
<b>Emphasis</b>	Political: emphasizes the throne	Spiritual: emphasizes the temple
<b>Content</b>	Historical	Theological
<b>Attributes</b>	God's justice	God's grace
<b>Protagonist</b>	Human responsibility	Divine sovereignty

Memory Acronym: KEEP A FORCE CAP (using the first letters of each category above)

- D. If one includes the genealogical section (1 Chron. 1–9; beginning 4143 BC, see p. 84) with the narrative (1 Chron. 10—2 Chron. 36; concluding 538 BC) the original single book of Chronicles covers more time than any book of Scripture (3606 years!).
- E. Chronicles is unique in that it contains the largest genealogy in the Bible (1 Chron. 1–9).
- F. The Book of Chronicles appears last in the Hebrew Bible (see p. 51).



## Argument

The central idea in Chronicles which unifies the entire account is the temple. The author's reason for emphasizing the temple is to encourage the returned remnant with the spiritual/divine perspective that while the Davidic *throne* is not among them, the Davidic *line* and *God Himself* is (1 Chron. 1—9); consequently, the people should learn from the judgment of their ancestors' idolatry and worship Him correctly with the temple as the center of the nation's worship. The chief matter in David's reign is his abundant preparations for building the temple (1 Chron. 10—29), the major part of the account of Solomon's reign is the construction and dedication of the temple (2 Chron. 1—9), and the remainder of the book includes only the kings of Judah as the northern kingdom is not related to the temple and the Davidic line (2 Chron. 10—36). Thus the emphasis on temple worship in Jerusalem alone is given to re-establish proper worship after many years of idolatry at various worship places.

## Synthesis

### David's line established

<b>1—9</b>	<b>Genealogy of Davidic line</b>
1—3	Davidic line back to Adam
4—8	Tribes (esp. Judah, Benjamin, Levi)
9:1-34	Remnant priests/Levites
9:35-44	Saul
<b>10—29</b>	<b>David's concern for the ark/temple</b>
10—12	Accession
10	Saul's death
11—12	David's heroes
13—17	Respect for ark
13	Incorrect transport
14	Prosperity
15—16	Correct transport
17	Davidic Covenant
18—20	Military victories
21—29	Temple preparations
21	Sinful census
22	Materials and charge
23—26	Temple leader reorganization
27	Civil/Military leader reorganization
28—29	Temple priority—last acts of commissioning and offering

## Outline

### Summary Statement for 1 Chronicles

**The spiritual perspective on the kingdom period in David's life is given to encourage the remnant with God's sovereign establishment of the Davidic line and to admonish proper temple worship—not the idolatry of the past.**

- I. (Chs. 1—9) A genealogical history from Adam to many years after the return from Babylon is given to encourage the remnant of God's grace in that while the Davidic throne is absent, the Davidic line is still present with the nation.
  - A. (Chs. 1—3) Genealogies back to Adam which emphasize the royal line of David are given to encourage the remnant of God's grace in that while the Davidic throne is absent, the Davidic line is still present with the nation even eight generations after the exile.
  - B. (Chs. 4—8) Genealogies of the twelve tribes emphasize Judah (4:1-23), Benjamin, and Levi (6:3-80) to instruct Israel in the importance of the Davidic and priestly lines as evidence of God's faithfulness and the people's need to respond faithfully to Him in return.

- C. (9:1-34) The genealogy of the remnant which emphasizes the priests and Levites provides the ancestry close to the time of the compiler as evidence for the legitimate priesthood required for proper worship of Yahweh.
- D. (9:35-44) The genealogy of Saul is repeated almost identically from 8:29-40 as an introduction to the death of Saul (ch. 10) and succession of David (11:1-3).

**II. (Chs. 10—29) The reign of David shows God's blessing on him in his military victories for his spiritual obedience shown in his concern for building a temple to house the ark permanently, recorded to show Israel proper worship.**

- A. (Chs. 10—12) David's accession to the throne occurs after Saul is removed as unfit for the kingship to show how David takes the throne as the ideal king.
  - 1. (Ch. 10) The death of Saul is recorded to get him out of the way before bringing in King David, the Messianic ideal, upon whom the rest of Chronicles is based.
  - 2. (Chs. 11—12) David's best warriors who secured strong support for his kingdom after his coronation and habitation of Jerusalem are listed to demonstrate how David as a near ideal king was able to rally strong support from his men.
- B. (Chs. 13—17) David's respect for the ark by bringing it to Jerusalem to rest in a temple is rewarded by God's promise of the Davidic Covenant which promises him a permanent dynasty and illustrates how blessing results from obedience.
  - 1. (Ch. 13) In his desire to make Jerusalem the religious center as well as the capital, David incorrectly brings the ark back from Kiriath Jearim at the cost of Uzzah's life which teaches the necessity of a proper attitude towards the holiness of God.
  - 2. (Ch. 14) David's prosperity as king is shown in his palace, numerous wives (?) and children, and victories over the Philistines.
  - 3. (Chs. 15—16) David properly transports the ark to Jerusalem and celebrates it with sacrifices, music, dancing, and continual ministry at the ark to demonstrate his respect for the ark learned from the Uzzah incident.
  - 4. (Ch. 17) David's desire to build God's house as a permanent place for the ark is noted by God's covenant to build *David* a house (dynasty), so the Davidic Covenant is God's reward for David's concern for Him and teaches blessing for obedience.
- C. (Chs. 18—20) David's military victories over the Philistines and other nations are recorded to demonstrate God's blessing upon him as a righteous king and one to whom God had promised an everlasting dynasty.
- D. (Chs. 21—29) David's preparations for the temple by selecting the site, collecting the materials, organizing the leaders, and commissioning the work all demonstrate the importance that temple worship should play in the life of the nation.
  - 1. (Ch. 21) David's sinful census to assess his military strength (which meets God's judgment by plague that kills Israelites up to the site of the future temple) is recorded to identify the circumstances surrounding the selection of the temple site.
  - 2. (Ch. 22) David prepares for the temple construction by collecting the materials and charging Solomon and Israel's leaders to build it.
  - 3. (Chs. 23—26) David prepares for the temple service by organizing the leaders to participate in the new temple worship since the tabernacle was to become obsolete.
    - a. (Ch. 23) The Levites are organized into new maintenance responsibilities for Gershonites, Kohathites, and Merarites since their old transportation responsibilities for carrying the tabernacle would become obsolete.

- b. (Ch. 24) The priests are organized into 24 divisions, each serving about two weeks a year on a rotating basis, to offer sacrifices before the LORD.
  - c. (Ch. 25) The musicians are organized into instrumentalists and singers to offer praise to the LORD in the ministry of prophesying.
  - d. (Ch. 26) The temple officers are organized into gatekeepers, treasurers, and administrators for smooth functioning of the temple.
4. (Ch. 27) David organizes the leaders of the nation of Israel into a unified military and political structure which would safeguard the temple from enemies.
5. (Chs. 28—29) David's final acts before his death are to command the people to build the temple according to God's plan, to accept their offerings, and to reaffirm Solomon as his divinely appointed successor, all done to affirm the temple's importance.
  - a. (Ch. 28) David commissions the nation and Solomon to follow the pattern God had revealed to him for the temple construction and service by Levites and priests so that it would be accomplished in God's manner after David's death.
  - b. (Ch. 29) David gives his own personal wealth and accepts offerings from the people for the temple, praises God publicly, and reaffirms Solomon as his rightful successor as his final acts before his death, to affirm the temple's importance.

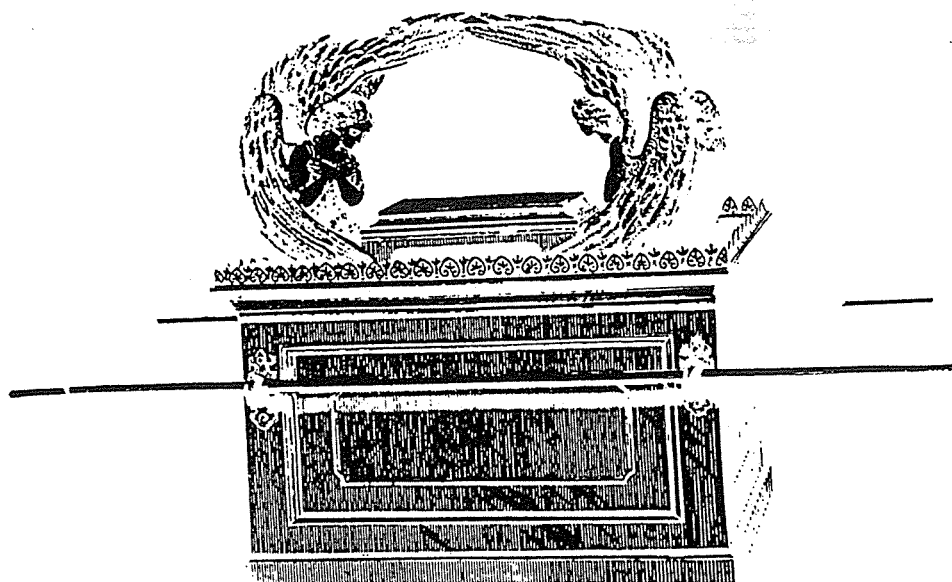

## Chronicles vs. Samuel/Kings

What's Missing in Chronicles but Included in Samuel/Kings?	What's <u>Included</u> in Chronicles but Missing in Samuel/Kings?
These are generally <i>negative</i> elements or related to Israel and royalty.	These are generally <i>positive</i> elements or related to Judah and the temple.
Michal despises David at ark (2 Sam. 6:20b-23)	Levites honor God at ark (1 Chron. 16:4-42)
Discipline aspects of the Davidic covenant (2 Sam. 7:14b)	Identification of the temple site even as God disciplines David's prideful census (1 Chron. 21:27-22:1; cp. 2 Sam. 24:25)
David's adultery with Bathsheba, murder of Uriah, and confrontation by Nathan the prophet (2 Sam. 11:2-12:25)	Divisions of Levites (1 Chron. 22-27)
David's troubles with Absalom (2 Sam. 13-19)	David's charge to Israel and Solomon and prayer (1 Chron. 28:1-29:22a)
Sheba's rebellion put down (2 Sam. 20)	Enterprises of Rehoboam (2 Chron. 11:5-23)
The execution of the Saulites (1 Sam. 21:1-14)	Abijam of Judah defeats Jeroboam of Israel by honoring the temple (2 Chron. 13:3-21)
Adonijah's rebellion against his father David (1 Kings 1)	Revivals under six kings of Judah, all "sons" of David (cf. p. 280)
David's charge to Solomon to avenge his opposers (1 Kings 2:1-9)	David's charge to Solomon to build the temple (1 Chron. 22:2-19)
Negative information on the kings of Israel and Judah (e.g., 1 Kings 13:1-14:20 on Jeroboam; 1 Kings 15:25-21:29 on others)	Positive details about kings of Judah: Asa (1 Chron. 14:6-15:15), Jehoshaphat (2 Chron. 17:1-19), Hezekiah (2 Chron. 32:27-30), etc.
Stories of Elijah (1 Kings 15:25-21:29) and Elisha (2 Kings 2:1-8:15; 13:14-25) since they ministered primarily in Israel	God's discipline by plague and enemy invasions upon Joram of Judah for his evil ways (1 Chron. 21:11-20)
Negative events after Judah's fall (2 Kings 25)	Renewal of Passover (2 Chron. 30) and other reforms of worship (2 Chron. 31)
The two falls of Israel (2 Kings 17:1-41 and 17:5-6; 18:9-12)	The end of Judah's exile (2 Chron. 36:22-23)

had the villages of Jair the son of Manasseh, which are in Gilead, and he had the region of Argob, which is in Bashan, sixty great cities with walls and bronze bars); <sup>(14)</sup>Ahinadab the son of Iddo, in Mahanaim; <sup>(15)</sup>Ahima-az, in Naphtali (he had taken Basemath the daughter of Solomon as his wife); <sup>(16)</sup>Baana the son of Hushai, in Asher and Bealoth; <sup>(17)</sup>Jehoshaphat the son of Paruah, in Issachar; <sup>(18)</sup>Shime-i the son of Ela, in Benjamin; <sup>(19)</sup>Geber the son of Uri, in the land of Gilead, the country of Sihon king of the Amorites and of Og king of Bashan. And there was one officer in the land of Judah.

### 58 The Extent of Solomon's Kingdom

*I Kings 4:20-21*

*II Chronicles 9:26*

<sup>(20)</sup>Judah and Israel were as many as the sand by the sea; they ate and drank and were happy.

<sup>(21)</sup>Solomon ruled over all the kingdoms from the Euphrates to the land of the Philistines and to the border of Egypt; they brought tribute and served Solomon all the days of his life.

<sup>(26)</sup>And he ruled over all the kings from the Euphrates to the land of the Philistines and to the border of Egypt.

### 59 Solomon's Wealth and Power

*I Kings 4:22-28*

<sup>(22)</sup>Solomon's provision for one day was thirty cors of fine flour, and sixty cors of meal, <sup>(23)</sup>ten fat oxen, and twenty pasture-fed cattle, a hundred sheep, besides harts, gazelles, roebucks, and fatted fowl. <sup>(24)</sup>For he had dominion over all the region west of the Euphrates from Tiphshah to Gaza, over all the kings west of the Euphrates; and he had peace on all sides round about him. <sup>(25)</sup>And Judah and Israel dwelt in safety, from Dan even to Beer-sheba, every man under his vine and under his fig tree, all the days of Solomon. <sup>(26)</sup>Solomon also had forty thousand stalls of horses for his chariots, and twelve thousand horsemen. <sup>(27)</sup>And those officers supplied provisions for King Solomon, and for all who came to King Solomon's table, each one in his month; they let nothing be lacking. <sup>(28)</sup>Barley also and straw for the horses and swift steeds they brought to the place where it was required, each according to his charge.

### 60 Solomon's Wisdom

*I Kings 4:29-34*

<sup>(29)</sup>And God gave Solomon wisdom and understanding beyond measure, and largeness of mind like the sand on the seashore, <sup>(30)</sup>so that Solomon's wisdom surpassed the wisdom of all the people of the east, and all the wisdom of Egypt. <sup>(31)</sup>For he was wiser

than all other men, wiser than Ethan the Ezrahite, and Heman, Calcol, and Darda, the sons of Mahol; and his fame was in all the nations round about. <sup>(32)</sup>He also uttered three thousand proverbs; and his songs were a thousand and five. <sup>(33)</sup>He spoke of trees, from the cedar that is in Lebanon to the hyssop that grows out of the wall; he spoke also of beasts, and of birds, and of reptiles, and of fish. <sup>(34)</sup>And men came from all peoples to hear the wisdom of Solomon, and from all the kings of the earth, who had heard of his wisdom.

### 61 Solomon's Preparations for the Temple Construction

*I Kings 5:1-18; 7:13-14*

*II Chronicles 2:1-18*

*I Kings 5:1-8*

<sup>(1)</sup>Now Hiram king of Tyre sent his servants to Solomon, when he heard that they had anointed him king in place of his father; for Hiram always loved David.

<sup>(1)</sup>Now Solomon purposed to build a temple for the name of the LORD, and a royal palace for himself.\*

<sup>(2)</sup>And Solomon assigned seventy thousand men to bear burdens and eighty thousand to quarry in the hill country, and three thousand six hundred to oversee them.†

<sup>(3)</sup>And Solomon sent word to Hiram the king of Tyre:

<sup>(2)</sup>And Solomon sent word to Hiram,

<sup>(3)</sup>"You know that David my father could not build a house for the name of the LORD his God because of the warfare with which his enemies surrounded him, until the LORD put them under the soles of his feet.

<sup>(4)</sup>But now the LORD my God has given me rest on every side; there is neither adversary nor misfortune.

"As you dealt with David my father and sent him cedar to build himself a house to dwell in, so deal with me.

<sup>(4)</sup>Behold,

I am about to build a house for the name of the LORD my God

<sup>(5)</sup>And so

I purpose to build a house for the name of the LORD my God, as the LORD said to David my father,

\*Cf. I Kings 5:5.

†Cf. I Kings 5:15.

# Chronicles

NEWS OF THE PAST

1941  
1007

VOL. I, NO. 11

## KING SAUL DIES HERO'S DEATH

### Takes Own Life on Mt. Gilboa As Israelite Army Collapses Under Philistine Onslaught; 3 of His Sons Killed in Action

#### TO OUR READERS

With this issue, we renew publication after a 3-day break brought about by the Philistine invasion. CHRONICLES is moving to Hebron — the city in which David has just been crowned King of Israel — and will henceforth be published in that city. The paper's position with regard to the present contest for the crown is set forth editorially on Page 2.

#### Who's King of Israel?

### DAVID AND ISH-BOSHET BOTH CLAIM CROWN

#### David, Crowned in Judah, Bases Claim on Anointment by Samuel

By a Staff Writer  
HEBRON, 22 Av. — Aviahur, sole survivor of King Saul's notorious massacre of the priests of Nob; today placed the crown of kingship on the head of David ben Yishai of Bethlehem — the man anointed by the late Prophet Samuel to be Saul's successor.

David is 36 years old. The ceremony was performed near the Cave of Machpelah, where the Patriarchs and their wives are buried. The prophets Gad and Nathan testified before the Elders of the tribe of Judah that David had been duly anointed upon his anointment that David should be king of Israel. At the moment, only the tribe of Judah supports

#### Ish-Boshet Says He's Legal Heir

(Chronicles News Service)  
MACHANAIM, 22 Av. — Ish-Boshet, Saul's fourth and sole surviving son, was crowned King of Israel today, in the presence of trial dignitaries and under the supervision of Abner ben Neri, Commander-in-Chief of the Israel Army.

Saul's other three sons were killed in the battle of Mount Gilboa. The coronation took place in a subdued atmosphere. A dazzling stillness hung over the assembly as General Abner spoke in quiet tones of King Saul's last moments and of his last order to Ish-Boshet, to save himself and his son, so that the royal house should not be utterly destroyed.

Abner lashed out at David, who is being crowned over a single tribe (Judah) in Hebron. "David's conduct," said Abner, "proves that King Saul was justified in trying to suppress him. It is clear now that David has been eyeing the crown for a long time."

#### Appeal for Loyalty

The Commander concluded his brief address with an appeal for loyalty. "Israel," he said, "must remain loyal to its first king and his sole legal heir, Ish-Boshet."

In a tense, tear-choked voice, Ish-Boshet then blessed the people and vowed to avenge his father and his brothers. He claimed David's right to the crown, retreating General Abner's statement that he, Ish-Boshet, was the only rightful heir to the throne.

#### THE SCEPTRE — AND JUDAH

In order to show that it was appropriate that the tribe of Judah should receive the crown, the Prophet Gad read out the blessing bestowed upon Judah by his father, Jacob: "Judah, you are the one whom brethren shall praise, Your hand shall be on the neck of your enemies. Your father's children shall bow down before you. The scepter shall not depart from Judah, nor a lawgiver from between his feet, until Shiloh come; and unto him shall the gathering of the people be."

his claim. It is hoped here, however, and several speakers today gave expression to this hope — that the other tribes will soon follow Judah in recognizing David as King of Israel.

David Devoeest  
It was a sad and weary David who arrived in Hebron yesterday, dressed in sackcloth and mourning the death of King Saul. His appearance aroused considerable astonishment among the local populace. They had expected a jubilant David, not one who was genuinely grief-stricken.

Among those who know David, David's grief is no surprise. Even in his worst times, when Saul pursued him and sought to take his life, David always showed a deep respect for King Saul, whom he recognized as the Lord's anointed. The Prophet Gad, in his address after the coronation, mentioned this admirable trait of David's, pointing out that this was one of the things that Continued on P. 4, Col. 7

### CIVIL WAR AVERTED

By Our Correspondent  
HEBRON, 22 Av. — It was only through the determined intervention of the Prophet Nathan that a civil war between the supporters of David and the adherents of Ish-Boshet was averted today.

The last speaker at David's coronation, Aviahur ben Tzaruih, demanded that the men of Judah march on Machanaim, Ish-Boshet's capital, so as to unite all the tribes of Israel under David's kingship.

The proposal won wide approval among the assembled crowd. But the Prophet Nathan interrupted the speaker and severely reprimanded him and those who would follow him for their willingness to shed the blood of their brethren.

#### Time Will Tell

"With our land surrounded by enemies," Nathan exclaimed, "you want to make war upon your own people? Such action will only lead to disaster! Let there be a king in Machanaim and one in Hebron. The future will show which of the two has been chosen by the Lord. When the time comes, all Israel will understand — and will come to the King of their own accord."

It has been learned that this pronouncement of Nathan's has David's sanction, and that David does not intend to provoke a conflict with the rest of the tribes.

### TYRE ALSO HAS A NEW KING

(Foreign News Service)  
TYRE — Tyre, the city which in recent years has risen to a position of leadership among the cities of the Phoenician coastal plain, also crowned a new king this week. Crown Prince Abihail succeeded his father to the throne of Tyre when the latter died earlier this week. Abihail's heir to the throne is Hiram, his first-born son.

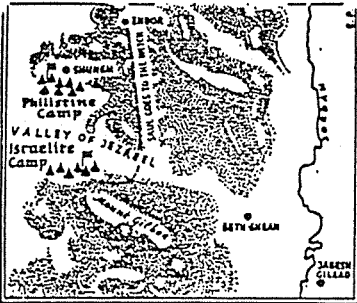

MT. GILBOA and vicinity; Scene of tragic events

### Saul's Body Rescued From Enemy Hands

By Our Correspondent  
YAVESH-GILEAD, 22 Av. — In a daring nocturnal manoeuvre, a group of Israelite youngsters from Yavesh Gilead last night rescued the bodies of King Saul and his three sons, to lay them to rest in Israel soil.

The corpses previously had been fastened by the Philistines to the wall of Beth Shan, which fell into Philistine hands after the Battle of Mount Gilboa. King Saul's corpse had been stripped of its armor, and his head had been severed from the body. The youngsters, who be-

### David's Family Returns From Moab Exile

BETHLEHEM, 22 Av. — David's family — his parents, his sisters-in-law and his children — returned today from their voluntary exile in Moab, which had served as a haven for them during the days of David's persecution at the hands of King Saul.

The returning party numbered more than 80. While in Moab, the Yishai clan resided in the tents of the families of Ruth and Orpah of Moab, who married the sons of Avimelech and Naomi three generations ago. Yishai is a grandson of Ruth.

### Leading Events During King Saul's Reign

- Victory over Ammonites at Yavesh Gilead.
- Establishment of Israel's first standing army, numbering 3,000 men.
- Victory over invading Philistine army at Michmash, (Jonathan, Saul's eldest son, played decisive role in this victory).
- Victory over Amalek and Samsel's domination of Saul for having spared Amalekites king and cattle.
- Appointment of David as private musician and armour-bearer to the King.
- David's spectacular triumph over Goliath and Israelite rout of Philistines.
- Promotion of David to army commander.
- Marriage of David to Michal, daughter of King Saul.
- Saul's pursuit of David, following David's growing success and popularity, and David's flight to Philistia.
- Philistine rout of Israelite army in Jezreel Valley and on Mount Gilboa.

By Our Military Correspondent  
WITH GENERAL ABNER AND THE REMNANT OF THE ISRAELI FORCES, SOMEWHERE IN GILBOA, 21 AV. — King Saul is dead. Jonathan, Avinadav, and Malchishai, three of his four sons, are dead. And the bodies of hundreds of Israelite troops lie strewn on Mount Gilboa and in the Valley of Jezreel — after the most savage battle to be fought in any war within our memory.

### MAN EXECUTED WHO BOASTED HE SLEW KING

(Chronicles News Service)  
ZIKLAG (Delays). — A young Amalekite who boasted to David that he had personally killed King Saul was executed by David for having raised his hand against the Lord's anointed.

The Amalekite, who arrived in Ziklag just a few hours after David's return from a successful military expedition against the Neguv, apparently thought he was having David a welcome piece of news.

But when he told David of the Israelite disaster on Mount Gilboa, David to the punishment of his informant, rent his clothes and broke into bitter tears.

Later, David had the Amalekite brought before him and questioned him minutely about the happenings on Mount Gilboa. According to the young man's story, King Saul was wounded and in a hopeless position when he asked the Amalekite to put him to death. The Amalekite complied with the King's wish, he said, and stabbed him to death.

In support of his contention, the brazen young man then produced Saul's crown and arm-band.

Enraged by the audacity of the man, who obviously expected a reward for his deed, David ordered Joab to bring him his side, to cut him down. The command was carried out on the spot.

#### WHY did Israel lose this crucial battle against the Philistines?

READ GENERAL ABNER'S ANSWER Behind the News PAGE 3

MAP: Our Country As It Looks Today — P. 4

The hastily-conscripted, ill-prepared Israelite army, which was the invading Philistines in the Jezreel Valley yesterday morning, has been completely routed, and the Philistine hordes are swarming unchecked over the countryside.

All night long, men, women and children all over Israel have been fleeing their homes — puzzled and bewildered at Israel's sudden turn in fortune, and terrified lest they be overrun by the merciless foe.

The battle reached its terrible climax shortly after midday, when the fighting was turned into a one-sided slaughter, with the

### Jonathan's Son Badly Injured

GIBEON, Benjamin. — Jonathan's 15-year-old son, Meribbaiah, sustained heavy injury to both his legs today when his nurse, in her haste to snatch up the child and flee the approaching Philistines, dropped him to the ground. It is feared the boy may be crippled for life as a result of the accident.

His father, King Saul's first-born, was killed in yesterday's battle.

Philistine chariots riding roughshod over our footmen, and their lethal arrows doing the rest.

#### Retreat to Gilboa

Those who managed to escape the carnage, among them King Saul and his sons and the commander-in-chief, General Abner, fled to Mount Gilboa for a last stand. Many did not stop to fight for the Jordan. General Abner and many others sought shelter not far from where the King was making his stand. Those who declined to take cover and remained with the King were killed by the Philistine archers.

Saul, who had been hit and was badly wounded, finally took his own life by falling on his sword.

The remnant of the beaten Israelite army, including King Saul's only remaining son, Ish-Boshet, fled to the opposite side of the Jordan, where they were joined later by General Abner and members of his staff. They are heading in the direction of Machanaim, where they are expected to set up their headquarters.

The commander stated that he himself had led the King, with a company of soldiers, to the slopes of Mount Gilboa, figuring that here he would be out of immediate danger; and that he had been able to hope he might be able to make an effective stand there on the mountain. But things worked out otherwise.

### Philistine Masses Go Wild As Victorious Army Returns

Special to CHRONICLES  
EKRON, Philistia, 22 Av. Wild victory celebrations were set off in Ekron today, as the first returning contingent of the victorious Philistine army began to stream into this city. When the severed head of King Saul was paraded through Ekron's main thoroughfare, the mob laughed and screamed with delight. People shouted until they were hoarse. Jokes of the coarsest calibre circulated among the men and women mobbing the streets, and their merriment knew no bounds: The coarser and more obscene the jest, the louder the raucous laughter with which it was received. "This time we really gave it to them!" announced one exuberant warrior, "wiped them out to a man!" A loud cheer went up when another shouted: "From now on, Philistia will be master in these parts!"

### Patriarchal Family Tree

John H. Walton, *Chronological and Background Charts of the Old Testament*

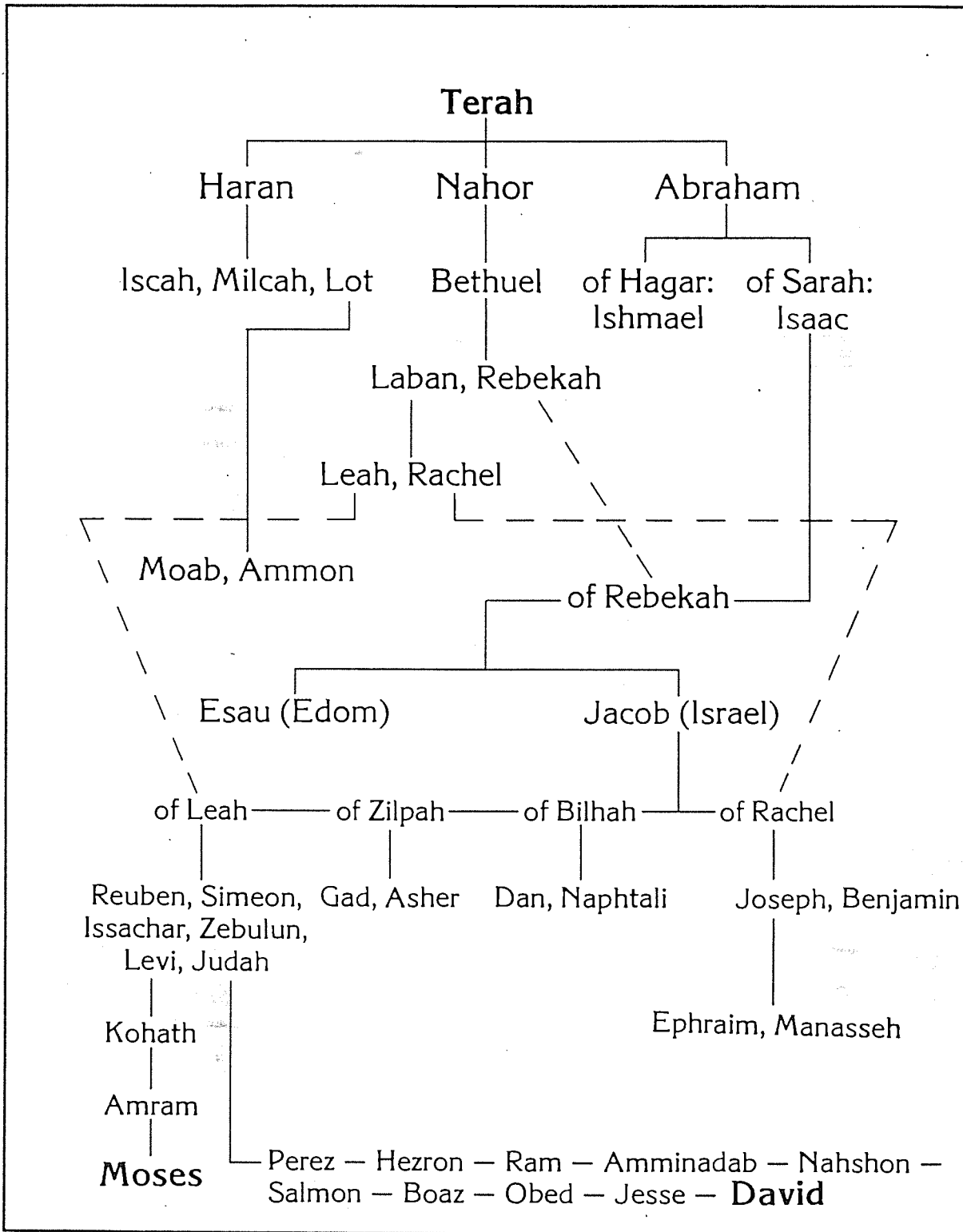

## Family and Ancestry of David

John H. Walton, *Chronological and Background Charts of the Old Testament*

<b>ANCESTRY</b> (Ruth 4:18-22; 1 Chron. 2:1-15)		
Patriarchs	Abraham — Isaac — Jacob — Judah	
Egypt	Perez — Hezron — Ram Amminadab — Nahshon	
Conquest and Judges	Salmon — Boaz — Obed — Jesse — David	
<b>FAMILY</b> (2 Sam. 3:2-5; 5:14-16; 1 Chron. 3:5-8)		
Children of Jesse	Wives of David	Sons of David
Sons: Eliab	Ahinoam	Amnon (killed by Absalom)
Abinadab	Abigail	Chileab (died in youth)
Shammah	Maacah	Absalom (killed by Joab)
Nethanel	Haggith	Adonijah (deposed by Solomon)
Raddai	Abital	Shephatiah
Ozem	Eglah	Ithream
David	Bathsheba	Solomon, Shimea, Shobab, Nathan
Daughters: Zeruiah (mother of Joab, Abishai, Asahel)	Michal	None
Abigail (mother of Amasa)	Various Concubines	Ibhar, Elishama, Eliphelet, Nogah, Nepheg, Japhia, Eliada, Elishama, Eliphelet



## 2 Chronicles

<b>David's Line Preserved</b>					
Solomon			Davidic Dynasty		
Chapters 1-9			Chapters 10-36		
Temple Constructed			Temple Destroyed		
Royalty			Ruins		
40 Years			393 Years		
971-931 BC			931-538 BC		
Wealth & Wisdom 1	Temple Construction 2-7	Successes & Death 8-9	Kingdom Divides via Rehoboam 10-12	7 Bad, 8 Good Kings 13-35	4 Bad Kings then Judah Falls 36
1 Kings 1-11			1 Kings 12-22	2 Kings 1-25	

**Key Word:** Preservation

**Key Verse:** "As for you [Solomon], if you walk before me as David your father did, and do all that I command, and observe my decrees and laws, I will establish your royal throne, as I covenanted with David your father when I said, 'You shall never fail to have a man to rule over Israel'" (2 Chronicles 7:17-18).

**Summary Statement:**

The spiritual perspective on the *preservation* of David's line despite the fall and exile of Judah is given to admonish the remnant to *proper temple worship*—not the idolatry of the past.

Stealing from the temple and leaving it in disrepair (12:9; 16:2-3) is contrasted with replenishing (15:18) and repairing it (24:4-14).

**Application:**

Humble yourself when the Lord exalts you lest you yourself become your own idol:

"Success is never final;  
 Failure is never fatal;  
 It is ~~courage~~ [no, humility] that counts."

—Winston Churchill, adapted

## 2 Chronicles

Note: The Introduction and Argument sections repeat the information in the 1 Chronicles notes. However, the Occasion section and the contrast chart between 1 and 2 Chronicles are new.

### Introduction

**I. Title** As was true for the Books of Samuel and Kings, so the Books of Chronicles originally comprised a single scroll. The Hebrew name (דברי הימים *Dib<sup>e</sup>re Hayyamim*) translates "The Words (Accounts, Events) of the Days," which in modern idiom means "The Events of the Times." The book was divided in the Septuagint with the name *Paraleipomenon*, "Of Things Omitted," referring to data lacking in Samuel and Kings. However, this title wrongly implies that Chronicles merely supplies omissions in Kings, which does not explain the parallel accounts and different emphases. The English title "Chronicles" is perhaps best. It stems from Jerome's Latin Vulgate (ca. AD 395) as he felt it chronicles the entire sacred history.

### II. Authorship

- A. External Evidence: The Talmud maintains that Ezra the priest authored the work, while some Talmudists believe that Nehemiah completed the genealogical tables (1 Chron. 1–9).
- B. Internal Evidence: The content verifies the external tradition in that the book emphasizes the temple, the priesthood, and the theocratic line of David in the kingdom of Judah. The style is very similar to the Book of Ezra, and both share a priestly perspective: genealogies, temple worship, ministry of the priesthood, and obedience to the Law (*TTTB*, 100). Ezra's authorship is especially supported by the fact that Ezra 1:1-3 repeats the closing verses of 2 Chronicles 36:22-23 almost identically.

### III. Circumstances

- A. Date: The references to the deportation of Judah (1 Chron. 6:15; 9:1) make it clear that the work was compiled after 586 BC, but another key passage shows the books were compiled after the return from Babylon. This passage (1 Chron. 3:17-24) reveals that the latest person recorded in Chronicles is Anani (v. 24) of the eighth generation from Jehoiachin (v. 17), who was taken captive to Babylon in 598 BC. Assuming 25 years for each of these eight generations places Anani's birth ca. 425 to 400 BC. However, Ezra authored the work and his ministry in Scripture does not stretch beyond ca. 445 (cf. Neh. 12:36). Therefore, the best estimate of the time of the compilation is between about 450-425 BC. The record of the Return (2 Chron. 36:22-23) also argues for a postexilic date.
- B. Recipients: Using the above date of 450-425 BC for compilation, the original readers comprised Jews who had been back in the land for about a century and probably had recently experienced the reconstruction of the Jerusalem walls under Nehemiah.
- C. Occasion: The Book of Kings (which covers roughly the same time period as Chronicles) had been written about a century earlier (ca. 550 BC) and would certainly have been deposited in Jerusalem. With the availability of Kings one can rightly wonder why Ezra saw a need to re-write the history of the nation in the Chronicles. The answer lies in his focus on the temple, designed to prevent the people from ever returning to the high places. Thus Kings records the history from a political/ethical standpoint, but Chronicles provides the spiritual/priestly perspective. It reminded the people that David's royal line still remained to encourage the small remnant who had returned and built a meager temple compared to Solomon's (cf. Hag. 2:3). Thus Chronicles was recorded to bolster the hopes of those who saw only a vague reminiscence of the glory of former days.

### IV. Characteristics

- B. Chronicles covers the same period of Jewish history begun in 2 Samuel (=1 Chron.) and stretches past 2 Kings (=2 Chron.). This kingdom period charted appears as such:

B. Chronicles covers the same period of Jewish history begun in 2 Samuel (=1 Chron.) and stretches past 2 Kings (=2 Chron.). This kingdom period charted appears as such:

		1 Chronicles		2 Chronicles				
<i>Books</i>	1 Samuel	2 Samuel	1 Kings	2 Kings				
<i>Kings</i>	Saul	David	Solomon- Ahaziah	Ahaziah- Zedekiah				
<i>Dates</i>	1043	1011	971	852	852	722	586	560 538
<i>Kingdom</i>	-----United-----		-----Divided-----		-Surviving-		-Returned-	

B. "All the books of the Bible, thus far, from Genesis to II Kings have pursued a chronological succession of events, right from Adam's creation to Judah's captivity; but now with the Chronicles we come to a writing which does not carry us forward . . . but goes back and reviews the whole story in order to derive and apply a vital lesson, namely, that *the nation's response to God is the decisive factor in its history and destiny*" (J. Sidlow Baxter, 2:179). Technically, 2 Chronicles 36:21-23 does carry the account forward, but these three verses cover only 48 more years to the return from exile under Cyrus.

C. Some contrasts between the two books of Chronicles may prove helpful:

	1 Chronicles	2 Chronicles
<b>History Covered</b>	Creation to Solomon enthroned	Solomon to Return from Exile
<b>Dates Covered</b>	4143-971 BC	971-538 BC
<b>Length</b>	3172 years	433 years
<b>Kings</b>	Saul-David (2 kings)	Solomon-Zedekiah (21 kings)
<b># of Chapters</b>	29	36
<b>General Content</b>	Success of Davidic kingdom	Success of Davidic kingdom (cont'd)
<b>Judgments</b>	No major ones	Judah (586 BC)
<b>Temple</b>	Preparations for Building	Built, then ruined 380 yrs. later
<b>Beginning/end</b>	Begins with genealogies and David's obedience	Ends with judgment for Davidic kings' disobedience

- D. If one includes the genealogical section (1 Chron. 1–9; beginning 4143 BC, see p. 84) with the narrative (1 Chron. 10—2 Chron. 36; concluding 538 BC) the original single book of Chronicles covers more time than any book of Scripture (3606 years!).
- E. Chronicles is unique in that this writing contains the largest genealogy in the entire Scripture (1 Chron. 1–9).
- F. The Book of Chronicles appears last in the Hebrew Bible (p. 51).

## Argument

The central idea in Chronicles which unifies the entire account is the temple. The author's reason for emphasizing the temple is to encourage the returned remnant with the spiritual/divine perspective that while the Davidic *throne* is not among them, the Davidic *line* and *God Himself* is (1 Chron. 1—9); consequently, the people should learn from the judgment of their ancestors' idolatry and worship Him correctly with the temple as the center of the nation's worship. The chief matter in David's reign is his abundant preparations for building the temple (1 Chron. 10—29), the major part of the account of Solomon's reign is the construction and dedication of the temple (2 Chron. 1—9), and the remainder of the book includes only the kings of Judah as the northern kingdom is not related to the temple and the Davidic line (2 Chron. 10—36). Attitudes toward the temple are seen in the contrast between stealing from it and leaving it in disrepair (12:9; 16:2-3) versus replenishing it (15:18) and repairing it (24:4-14). Thus the emphasis on temple worship in Jerusalem alone is given to re-establish proper worship after many years of idolatry at various worship places.

## Synthesis

### David's line preserved

<b>1—9</b>	<b>Solomon</b>
1	Wealth/Wisdom
2—7	Temple construction
2	Preparation
3:1—5:1	Building
5:2—7:22	Dedication
8—9	Successes
8:1-11	Political
8:12-16	Spiritual
8:17—9:28	Economic
9:29-31	Death
<b>10—36</b>	<b>Davidic dynasty (good kings in bold print)</b>
10—12	Rehoboam
13	Abijah (Abijam)
<b>14—16</b>	<b>Asa</b>
<b>17—20</b>	<b>Jehoshaphat</b>
21	Jehoram
22:1-9	Ahaziah
22:10—23:21	Athaliah
<b>24</b>	<b>Joash</b>
<b>25</b>	<b>Amaziah</b>
<b>26</b>	<b>Uzziah (Azariah)</b>
<b>27</b>	<b>Jotham</b>
28	Ahaz
<b>29—32</b>	<b>Hezekiah</b>
33:1-20	Manasseh
33:21-25	Amon
<b>34—35</b>	<b>Josiah</b>
36:1-3	Jehoahaz
36:4-8	Jehoiakim
36:9-10	Jehoiachin
36:11-14	Zedekiah
36:15-21	Fall of Jerusalem (586 BC)
36:22-23	Return under Cyrus (538 BC)

## Outline

### Summary Statement for 2 Chronicles

**The spiritual perspective on the kingdom period from Solomon to the return from Babylon is given to encourage the remnant with God's sovereign *preservation of the Davidic line* and to admonish *proper temple worship*—not the idolatry of the past.**

- I. (Chs. 1—9) **The reign of Solomon shows God's blessing on him in his obedience in building the temple to show Israel proper worship.**
  - A. (Ch. 1) The LORD blesses Solomon's proper worship with wisdom and wealth as an example of His blessing upon all who truly honor Him.
  - B. (Chs. 2—7) Solomon's construction and furnishing of the temple meets God's approval in its filling with the *shekinah* glory.
    1. (Ch. 2) Solomon prepares to build the temple by hiring 153,600 workers and requesting timbers and artisans from Hiram of Tyre so that the best possible temple might be constructed.
    2. (3:1—5:1) The temple is built and filled with new furnishings, including the excess gold and silver for the treasuries, in anticipation of the arrival of the ark.
    3. (5:2—7:22) After the return of the ark and *shekinah* glory, Solomon dedicates the temple with a message and prayer which meets both God's and the people's approval.

### Parallels between David's and Solomon's Transfers of the Ark

	<u>David</u> (1 Chron.)	<u>Solomon</u> (2 Chron.)
<i>Ark location before transfer</i>	Kiriath Jearim	City of David
<i>Ark location after transfer</i>	House of Obed near the City of David	Temple on Moriah (former threshing floor of Araunah)
<i>Consultation with Israel's leaders &amp; national procession</i>	13:1-5	5:2-3
<i>Transports the ark correctly</i>	15:1—16:3	5:2-10
<i>Celebration of praise at arrival</i>	16:7-36	5:11-14
<i>System of regular worship set up</i>	16:4-6, 37-42	8:12-16
<i>Divine revelation given</i>	17:1-15	7:12-22
<i>Prayer by the king</i>	17:16-27	6:12-42

- C. (Chs. 8—9) Solomon's political, spiritual, and economic successes are recorded as God's blessing for his honoring the temple.
  1. (8:1-11) Solomon's political success is evident in his building of several cities, conscripting Canaanites as slaves, and marriage to Pharaoh's daughter.
  2. (8:12-16) Solomon's spiritual success is seen in his keeping Israel's ordinances and feasts with the Levitical divisions appointed by his father David.
  3. (8:17—9:28) Solomon's economic success is noted in his ships, gold, visit by the queen of Sheba, golden temple shields, ivory and gold throne, wisdom, horses, chariots, silver, and other material blessings.
  4. (9:29-31) Solomon's death after a 40 year reign is recorded as introduction to the remainder of the book which reveals what happened to the temple.

**II. (Chs. 10—36) The reign of the Davidic dynasty in Judah despises the temple, which God judges in the destruction of the temple at the fall of Jerusalem to teach post-exilic Israel the importance of proper worship in its new temple.**

- A. (Chs. 10—12) Rehoboam's division of the kingdom and occupation by Egypt for raiding the temple treasures is recorded to teach post-exilic Israel the importance of proper worship in its new temple and the consequences of disobedience.
1. (Ch. 10) The division of the kingdom because of Rehoboam's commitment to overwork the people teaches that God blesses righteous leadership but punishes evil.
  2. (Ch. 11) Rehoboam's strong fortifications and large family are mentioned as indication of God's initial blessing upon the kingdom of Judah by strengthening it.
  3. (Ch. 12) God weakens Judah for Rehoboam's abandoning the Law by His delivering the fortified cities and temple treasures over to Shishak of Egypt to teach Rehoboam that serving the LORD is far better than serving foreign powers, then Rehoboam repents.
- B. (Ch. 13) Abijah's (Abijam) evil reign is presented in a positive light in his defeat of Jeroboam of Israel as an indication of God's blessing upon the house of David and the legitimate temple priesthood (even though Abijah was an idolater; cf. 1 Kings 15:1-8).
- C. (Chs. 14—16) Asa brings reform to the nation through removing all idolatry from Judah (although the high places in Israel remain), but his robbery of the temple to pay Aram to defeat Baasha of Israel is judged with a foot disease to show the need to respect God's house.
- D. (Chs. 17—20) Jehoshaphat adds more reforms to those of his father by personally traveling throughout the land appointing judges so that the people would follow the LORD, and he experiences victory over a foreign alliance but sins by allying with Israel himself.
- E. (Ch. 21) Jehoram's evil reign due to marrying Athaliah, daughter of Ahab, sees victory over Edom but loss of every relative except his son Ahaziah because of God's commitment to the Davidic Covenant, then death by an incurable bowel disease for his wickedness.
- F. (22:1-9) Ahaziah's evil reign due to the influence from his wicked mother Athaliah is judged in Jehu's execution of Ahaziah and Ahab's entire house but the family line is not blotted out because of God's protection of the Davidic line.
- G. (22:10—23:21) Athaliah's evil reign destroys the entire royal family except her one year old grandson Joash, who six years later is crowned by Jehoiada the priest while Athaliah is executed to demonstrate God's protection of the Davidic line.
- H. (Ch. 24) Joash reigns righteously by rebuilding the temple while Jehoiada the priest lives, but then he murders Jehoiada's son for prophesying against his abandoning the temple for idolatry and is himself executed by Aram to teach respect for the temple.
- I. (Ch. 25) Amaziah partly obeys God by executing only his father's murderers (not their sons) and not hiring troops from Israel, but he promotes idolatry with idols taken after defeating Edom, then is himself defeated after picking a fight with Jehoash of Israel.
- J. (Ch. 26) Uzziah's (Azariah) good reign in Judah lasts 52 militarily strong years but in pride he unlawfully offers incense in the temple and is judged with leprosy and life in a separate house as an example of the need for proper temple worship.
- K. (Ch. 27) Jotham reigns according to the Law by not entering the temple and becomes powerful over Ammon as God's blessing for his respect for the temple.
- L. (Ch. 28) Ahaz's evil reign in Judah breaks the 105 consecutive years of good Judean kings by sacrificing his own son, constructing and worshipping at the high places, and appealing to Tiglath-Pileser rather than God for protection from Pekah and Rezin.

- M. (Chs. 29—32) Hezekiah reforms the temple worship by reorganizing the priests so the Passover can be celebrated in a re-establishment of proper worship, which God rewards by defeating Sennacherib, but after Hezekiah expresses pride and repents he dies.
- N. (33:1-20) Manasseh's 55 year reign (the longest of any king) reinstates all pagan practices destroyed by Hezekiah his father but after an Assyrian exile he repents, is restored his kingdom, and removes all idols except Yahweh worship at the high places.
- O. (33:21-25) Amon's evil reign repeats Manasseh's mistakes except he never repents, then he is assassinated by his officials, who are themselves assassinated by the people, who place Amon's son Josiah on the throne.
- P. (Chs. 34—35) Josiah's good reign desecrates all pagan altars and recovers the Book of the Law (Deuteronomy?) during temple repairs which motivates him to renew the Mosaic Covenant and celebrate the Passover, then he dies defending Babylon against Pharaoh Neco.
- Q. (36:1-3) Jehoahaz's reign soon ends in subjugation to Pharaoh Neco after only three months followed by exile and death in Egypt and replacement by his son Jehoiakim (Eliakim before Pharaoh changes his name).
- R. (36:4-8) Jehoiakim's evil reign results in his deportation by Nebuchadnezzar of Babylon [along with some citizens such as Daniel; cf. Dan. 1:1-7] along with some of the temple articles (605 BC).
- S. (36:9-10) Jehoiachin's evil reign surrenders after only three months and ten days during Nebuchadnezzar's second invasion (597 BC), who takes more temple treasures and Jehoiachin himself [Ezekiel also], replacing him with his uncle Zedekiah.
- T. (36:11-14) Zedekiah's evil reign for eleven years spurns Jeremiah's warnings to repent and rebels against Nebuchadnezzar, which encourages the people and even the priests in idolatry that defiles the temple, thus desecrating what God had consecrated.
- U. (36:15-21) Israel's lack of repentance results in Nebuchadnezzar's third and final siege (586 BC) that loots and burns Solomon's temple and the palaces, breaks down the wall, and sends the remnant into a 70 year captivity so that the land can enjoy its Sabbath rests.
- V. (36:22-23) Cyrus' decree (538 BC) commands the rebuilding of the destroyed temple in Jerusalem in fulfillment of Jeremiah's prophecy (cf. Jer. 25:11-12; 29:10) as a final encouragement to the returnees that God has not forgotten His house.

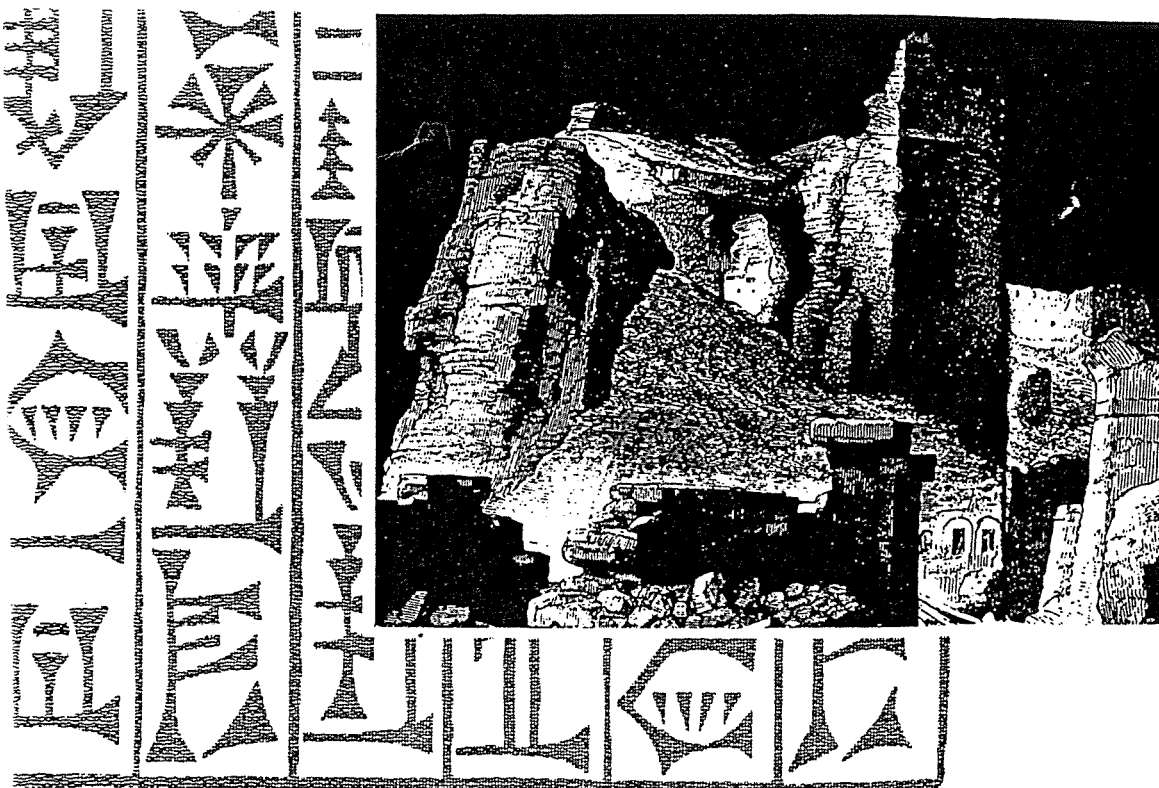

# Decline of the Kingdoms

Huang Sabin, Singapore Bible College

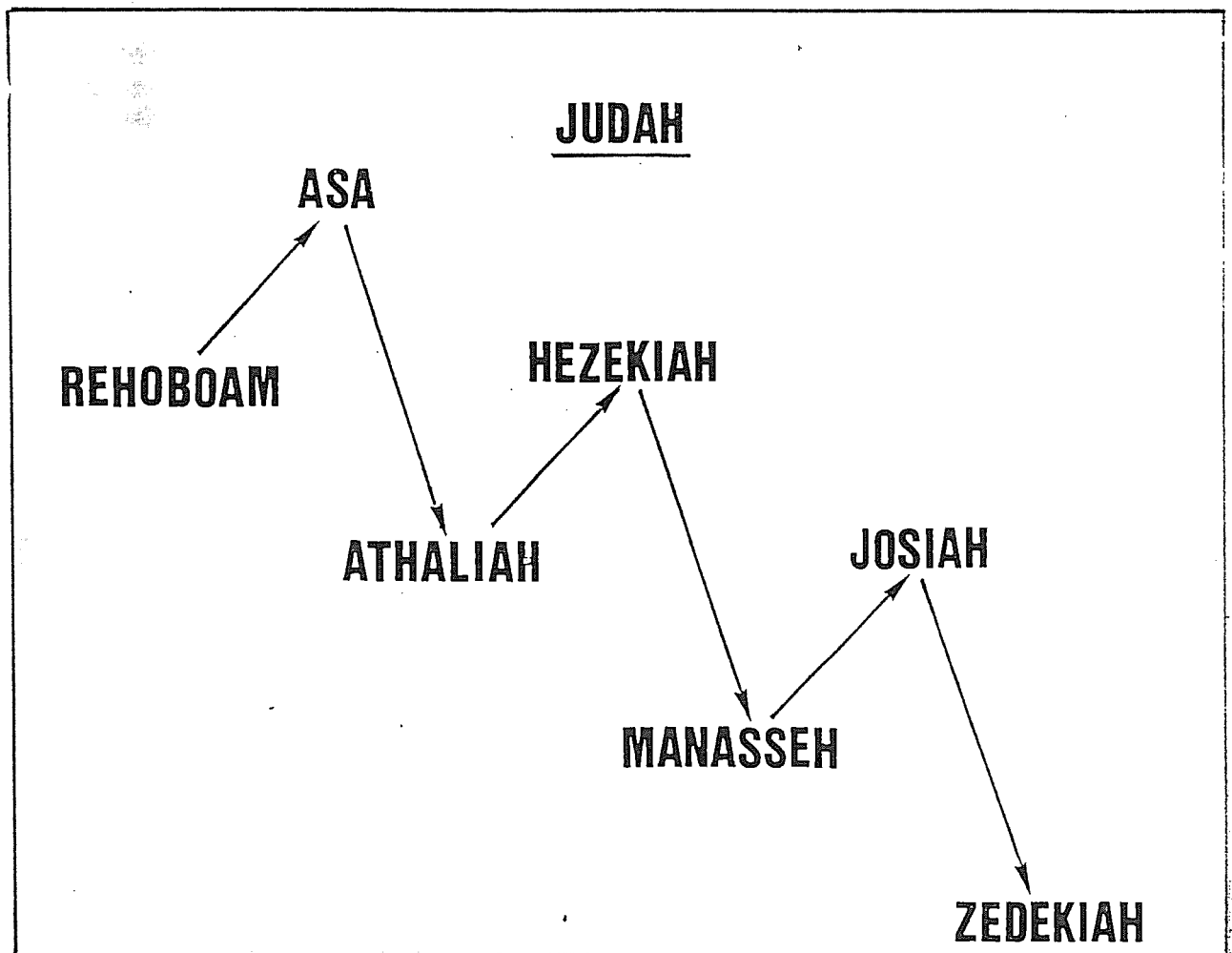
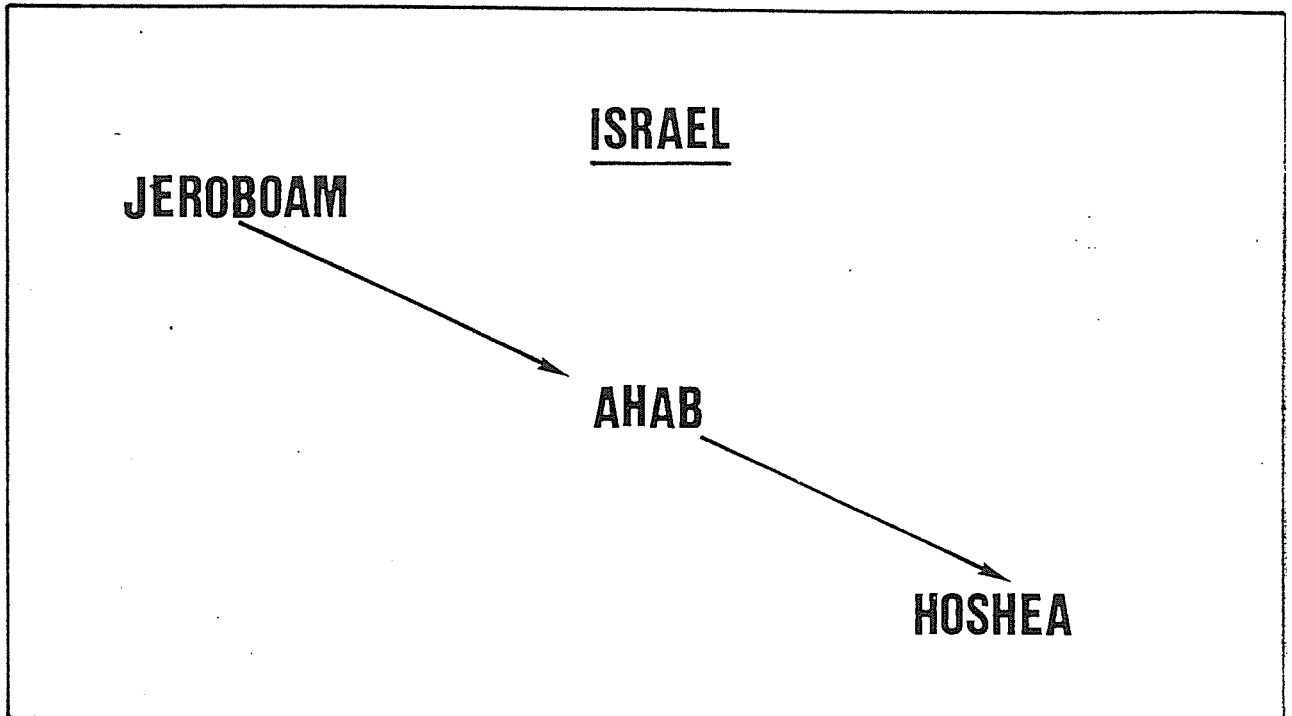



## Patterns of Judean Kings' Rule

The writers of both Kings and Chronicles deem every king in the northern nation of Israel as evil. However, with the southern nation of Judah it becomes more complicated. Although the writers give an “evil” or “righteous” summary for each reign, it is difficult to categorize every king as either *totally* “good” or “bad.” This is because some began well but ended poorly, or *vice versa*. Essentially these twenty-two kings (including David and Solomon) fall into four types. (Scripture references below refer to 2 Chronicles unless otherwise noted.)

### Good with a Bad End (8)

Solomon\* (1:1; cf. 1 Kings 11:6),  
Asa (14:2), Jehoshaphat (17:3; 20:37),  
Joash (24:22), Amaziah (25:19, 27),  
Uzziah (26:16), Hezekiah (32:25),  
Josiah (34:1–36:1)

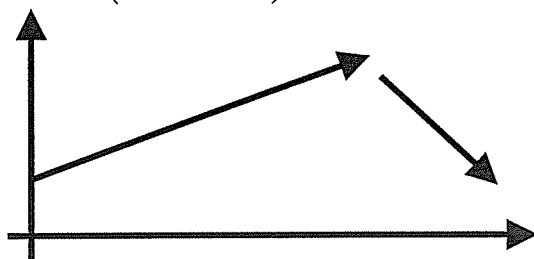

### Bad with a Good End (3)

Rehoboam (12:6-7, 12), Abijah\*\*  
(=Abijam; 13:10; 1 Kings 15:3),  
Manasseh (33:12, 19)

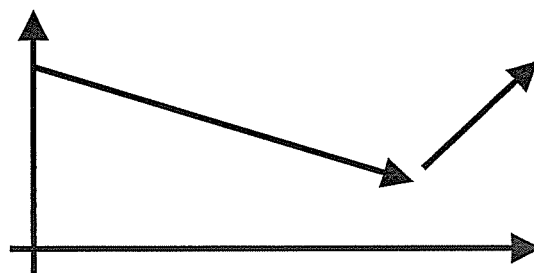

### Good to Better (2)

David (1 Kings 3:6),  
Jotham (27:6)

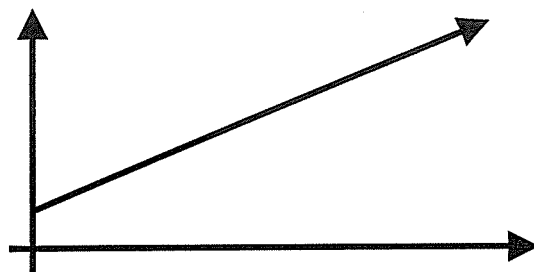

### Bad to Worse (9)

Jehoram (21:6, 11-12), Ahaziah  
(20:35; 22:3), Athaliah (22:10), Ahaz  
(28:22), Amon (33:20-25), Jehoahaz  
(36:1; cf. 2 Kings 13:2), Jehoiakim  
(36:5), Jehoiachin (36:9), Zedekiah  
(36:12)

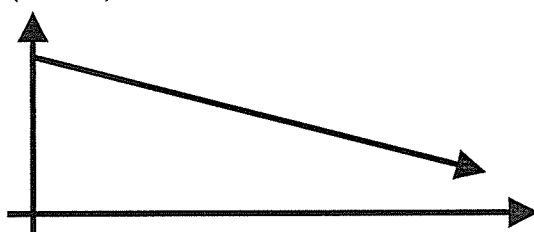

\* Although Solomon was noted as rich and wise “for the LORD his God was with him and made him exceedingly great” (2 Chron. 1:1 NIV), the writers seem to avoid categorizing him as either “evil” or “good.”

\*\* Abijah (= Abijam) is said to have been evil in 1 Kings 15:3 while the Chronicler notes only his trust in the LORD (2 Chron. 13:10). His placement in the “bad with a good end” category above seeks to represent both perspectives.

## Revivals in 2 Chronicles

Revival #	1	2	3	4	5	6
<b>Chapters</b>	15	20	23—24	25	29—31	34—35
<b>Kings</b>	Asa	Jehoshaphat	Joash (via Jehoiada)	Amaziah	Hezekiah	Jostah
<b>Actions</b>						
<b>Results</b>						

**“If my people, who are called by my name, will humble themselves and pray and seek my face and turn from their wicked ways, then will I hear from heaven and will forgive their sin and will heal their land” (2 Chronicles 7:14).**

## Israel's Later Eastern Neighbors

John H. Walton, *Chronological and Background Charts of the OT*, 2d ed., 72

MOAB	AMMON	EDOM
930—At the time of division, all were subjugated to the nation of Israel		
925—Revolted during reign of Jeroboam and gained freedom	925—Declared freedom from Jeroboam	Remained under the control of Judah
877—Subjugated by Omri	853—Baasha of Ammon allied with Ahab and others against Assyria at Qarqar	
Coalition against Jehoshaphat in 853 defeated at En-gedi (2 Chron. 20:1)		
850—King Mesha revolted against Jehoram of Israel and gained freedom (2 Kings 3:4-27)	Retained freedom	845—Revolted against Jehoram of Judah and gained freedom (2 Chron. 21:8-10)
		794—Defeated by Amaziah (2 Chron. 25:11-13)
780—Uzziah and Jeroboam II subjugated all three		
Remained subjugated	738—Gained freedom from Jotham (2 Chron. 27:5)	735—Gained freedom from Ahaz (2 Chron. 28:17)
732—All became Assyrian tributaries		
711—Conquered by Sargon	Remained as Assyrian tributaries	
690—Rebellion suppressed by Sennacherib		
612—Gained partial freedom with fall of Nineveh—607—Raided Judah for Babylon		
605—Subjugated by Nebuchadnezzar 581—Rebelled and was conquered	581—King Baalis rebelled and was conquered	601—Became and remained Babylonian tributary

## Nebuchadnezzar's Six Deportations to Babylon

Sequence & Size	Date	King of Judah	Number Taken	Key Captives	Results/Comments
1 Minor	605 BC	Jehoiakim	Few (Dan. 1:3)	Daniel, his 3 friends, & other nobility & royalty	Tribute imposed. Egypt powerful.
2 Moderate	598 BC	Jehoiakim	3,023 (Jer. 52:28)	-	Minor deportation before the 597 BC deportation
3 Major	597 BC	Jehoiachin	10,000 (2 Kings 24:14)	Jehoiachin (2 Kings 24:12b), Ezekiel (Ezek. 1:2), Mordecai (Esther 2:6)	Large deportation. Jehoiachin replaced with his uncle Zedekiah.
4 Minor	587 BC	Zedekiah	832 (Jer. 52:29)	-	Minor deportation before the 586 BC destruction
5 Major	586 BC	Zedekiah	ca. 10,400* (2 Kings 25:11)	Zedekiah	Jerusalem & temple destroyed after 30 month siege
6 Minor	582 BC	-	745 (Jer. 52:30)	-	Four years after Jerusalem's destruction

\* Jeremiah 52:30b says that 4600 people were brought into captivity during the minor deportations (598, 587, and 582 BC). However, assuming the total captives reached about 25,000 (Eugene H. Merrill, Kingdom of Priests, 471), since the 597 deportation took 10,000 captives (2 Kings 24:14) then the fall in 586 must have included approximately 10,400 exiles (25,000 - 10,000 - 4600 = 10,400).

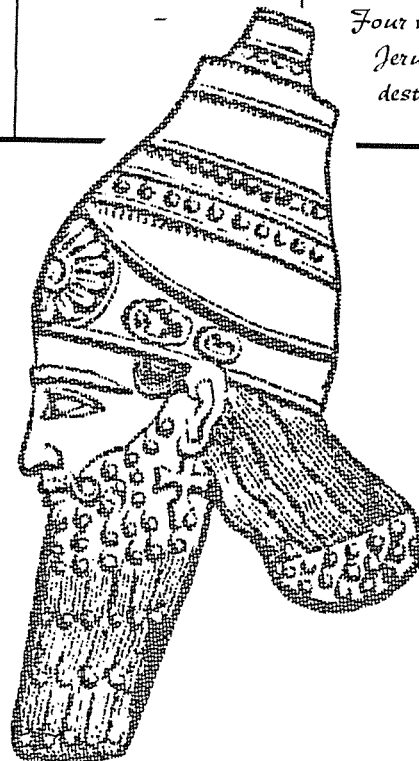

STUDY-GRAPH

© 1962 by John C. Whitcomb

BABYLONIAN CAPTIVITY

JOHN C. WHITCOMB, Th.D.
Professor of Theology and Old Testament
Grace Theological Seminary
Winona Lake, Indiana

BMH Books
P. O. Box 544

Winona Lake, IN 46590

NOTES

- 1. Ashurbanipal (668-633) was famous for his campaigns against Egypt and Elam...
2. Nineveh had been under siege by the armies of Cyaxares the Mede...
3. Shamash-shum-ukin (brother of Ashurbanipal) was made ruler of Babylon (669) by his father, Esarhaddon...
4. In May 605, Nabopolassar (in poor health) sent his son Nebuchadnezzar against the Egyptians of Carchemish...
5. Hearing of his father's death, Nebuchadnezzar took the short route across the Arabian Desert...
6. Elam revolted against the Assyrians, but Ashurbanipal crushed the Elamites...
7. Western kings who took advantage of the Elamite revolt to withhold their tribute were crushed by the Assyrians...
8. Jeremiah, son of Hilkiah (not the high priest who discovered the Book of the Law), was born in Anathoth...
9. After defeating the Egyptians under Necho II at the Battle of Carchemish (May-June 605), Nebuchadnezzar "conquered all of the Hatti country" (Syria and Palestine) and besieged Jerusalem...
10. An Assyrian revolt in Babylon was crushed by Nebuchadnezzar...
11. Nebuchadnezzar began a partially successful thirteen-year siege of Tyre (Ezek 26:2-8; cf. 29:18)...
12. Nahum prophesied the destruction of Nineveh, using the destruction (663) of No-amon (Thebes) as an example...
13. Early in Josiah's reign, Zephaniah preached against the sins of Judah...
14. Habakkuk foresaw the rise of Babylon as a world power...
15. Daniel and his three friends were taken to the court of Babylon for intensive training...
16. Ezekiel saw in Babylon (July 31, 593) the vision of the four cherubim and the wheels...
17. Jehoahaz (Shallum), a younger son of Josiah, was anointed king by the people, but after three months was deposed and taken to Egypt by Necho II...
18. Jehoiaquin (also named Coniah and Jeconiah), a son of Jehoiaquin, was eighteen when his father died...
19. Jehoiachin was taken captive by Nebuchadnezzar (March 16, 597)...
20. A Babylonian tablet lists Jehoiachin and his five sons among those who received regular rations in Babylon...
21. Word reached Ezekiel (January 8) in Babylon that Jerusalem was destroyed...
22. Though very wicked during most of his fifty-five-year reign, Manasseh repented when Ashurbanipal carried him off to Babylon...
23. Amon, the wicked son of Manasseh, was murdered by his servants...
24. Josiah was eight years old when he began to reign...
25. Josiah began "to seek after the God of David his father" at the age of sixteen...
26. Josiah (aged twenty) began to purge Jerusalem, Judah, and the northern provinces...
27. Hilkiah (high priest) discovered the Book of Law in the Temple...
28. Josiah was killed (spring 609) by Necho II at Megiddo...

- 35:25; cf. Zech 12:11, and was followed on the throne by three sons and a grandson.
29. Eliakim (elder brother of Jehoahaz) was made king by Necho II, who changed his name to Jehoiaquin.
30. Jehoiaquin became a vassal of Nebuchadnezzar.
31. Jehoiaquin cut Jeremiah's scroll and threw it into the fire.
32. After serving three years, he rebelled against Nebuchadnezzar.
33. Jehoiaquin died in Jerusalem (December 10, 598) and was given a disgraceful burial as prophesied (Jer 22:18, 36:30).
34. Mattaniah, Jehoiachin's uncle, was made king of Judah by Nebuchadnezzar, and his name was changed to Zedekiah. In spite of Jeremiah's warnings (chaps. 27-28), he plotted against Babylon.
35. When Jerusalem fell, Zedekiah tried to escape to Jordan. He was captured at Jericho, carried to Riblah, blinded after seeing his sons slain, and deported to Babylon, where he died.
36. The siege of Jerusalem lasted from January 15, 588, to July 18, 586.
37. One month after the fall of Jerusalem, Nebuzaradan, the captain of the guard, burned the city and Temple (Jer 3:16), looted Temple treasures, and brought Seraiah (high priest) and others to Nebuchadnezzar at Riblah for execution (2 Kings 25:8-21). Gedaliah was appointed governor of the land, and Jeremiah remained with him at Mizpah...
38. In 605, Jeremiah prophesied the seventy-year captivity of Judah (chap. 25). That same year his scribe, Baruch, complained of his hard lot (chap. 45).
39. Necho II battled Nebuchadnezzar to a standstill on the border of Palestine and Egypt.
40. Nebuchadnezzar captured 3,023 Jews in a preliminary campaign (Jer 42:26).
41. Psamtik II attacked Phoenicia (590) to harass Nebuchadnezzar.
42. Pharaoh Hophra (Apries) came to the aid of Zedekiah, causing Babylon to lift its siege of Jerusalem temporarily (Jer 37:7, 11). This may have been the time of the captivity of the 832 Jews (Jer 52:29).
43. Psamtik I, the first pharaoh of the twenty-sixth (Saitic) Dynasty, was put into power by Ashurbanipal in 663, following the Assyrian conquest of Egypt (667). He broke from Assyrian control in 654, and a revival of Egyptian culture followed.
44. In order to have a buffer state between Egypt and its potential enemies, Psamtik I moved north to support the tottering Assyrian Empire against the advancing Medes and Babylonians.
45. Until 550, Persian kings were vassals of the Medes. One vassal, Cambyes (600-559) married Mandane, a daughter of Astyages, and their son was Cyrus II, the Great. Amytis, another daughter of Astyages, was a wife of Nebuchadnezzar. Her homesickness caused him to construct the famous Hanging Gardens of Babylon.
46. Croesus, the wealthy king of Lydia, refused to acknowledge the sovereignty of Persia. Cyrus defeated him and absorbed his kingdom into the empire. For the next six years, Cyrus prepared to conquer Babylon.
47. Cyrus II succeeded his father as king of the small Persian kingdom of Anshan (559). Soon he began to foment rebellion against his grandfather, the corrupt Astyages. He was encouraged by Nabonidus, the new king of Babylon. Astyages tried to crush the revolt, but his general, Harpagus, whom he had previously wronged, deserted him and brought his army over to Cyrus. The Median king was soon seized by his own men, and the Persians took the capital city of Ecbatana (550) without a battle. From then on, the Medes and Persians fought together under the leadership of Cyrus.
48. Darius the Mede, probably the "Gubaru" of the Nabonidus Chronicle, was a subordinate of Cyrus who appointed governors in Babylon (e.g., Daniel; Dan 6:1-9) on October 29, after Ugbaru took the city. He was sixty-two (Dan 5:31), and the tablets indicate that he ruled Babylon, Syria, and Palestine until 525.
49. From 539 to 530, Cambyes lived in Sippar, representing his father, Cyrus (who was busy extending the eastern frontiers) at the New Year's festival in Babylon. He was also to prepare for a great expedition against Egypt, which he conquered in 525, five years after his father's death.
50. Darius—Hystaspes (521-486) is known as Darius the Great because of his brilliant achievements in restoring the Persian Empire amidst the chaos following the death of Cambyes. Cambyes died (suicide?) while returning from the conquest of Egypt upon hearing that a pretender (who claimed to be Smerdis, another son of Cyrus whom Cambyes had secretly murdered for suspected disloyalty) had taken the throne of Babylon. The Achaemenid dynasty of Persia would have ended with Cambyes had not Darius, son of Hystaspes, retained the loyalty of the Persian army. In two months he captured and killed the pseudo-Smerdis (whose real name was Bardiya or Gaumata, and who ruled Babylon from March to September 522), and during the next two years he defeated nine kings in nineteen battles. His own account of those victories is recorded in a large trilingual cuneiform inscription (Old Persian, Babylonian, Elamite) on the face of the Behistun Rock. He is most famous for reorganizing the empire into satrapies and for his ill-fated efforts against the Greeks (493 and 490).
51. After building the city of Babylon and subduing his enemies, Nebuchadnezzar was punished by God for his pride. In the "times" of Daniel 4:32 refer to years (cf. 7:25), which was mad for the last seven years of his reign.
52. Evil-Merodach (Amel-Marduk), son of Nebuchadnezzar, lifted Jehoiachin out of prison April 2, 561, and honored him for the remainder of his life (Jer 52: 2 Kings 25).
53. Nergal-shar-usur, a son-in-law of Nebuchadnezzar, murdered Evil-Merodach and seized the throne in August 560. A news bulletin tablet tells of his campaign to Cilicia (557). He was probably the Nergalshazzar who had the office of rab mag at the siege of Jerusalem in 586 (Jer 39:3,13).
54. Labashi-Marduk, son of Nergilassar, reigned but two months (May-June 556), and was murdered by some conspirators including Nabonidus, a Babylonian noble and son-in-law of Nebuchadnezzar.
55. From 553 to 539, while he attempted to build a commercial center at Tema in Arabia, Nabonidus left the administration of Babylon to his profligate son Belshazzar. That he had incurred the wrath of the official Marduk priesthood by

concentrating his favors on the cult of the moon god Sin may explain his desire to live as far from Babylon as possible. When Cyrus threatened invasion, Nabonidus came to Babylon for the New Year's festival of April 4, 539, and sought divine protection for the city by bringing the images of Babylonian gods in from surrounding towns. It was to no avail. In September, the armies of Cyrus, commanded by Ugbaru, defeated the Babylonians at Opis. On October 10, Sippar (thirty miles north of Babylon) was taken without a battle, and Nabonidus fled. Two days later, Ugbaru's troops entered Babylon and killed Belshazzar.
For over two thousand years, the book of Daniel contained the only known historical reference to Belshazzar. In the late nineteenth century, some cuneiform tablets that refer to Bel-shar-usur (Bel protect the king) as "son of the king" (imar-sharr) were unearthed. In the early twentieth century, a tablet was published stating that Nabonidus "entrusted the kingship" to his son when he went to Arabia, indicating that he was the de facto king of Babylon when it fell. It is significant that Belshazzar's highest office (Daniel was to make him "third ruler of the kingdom" (Dan 5:7,16,29). On October 12, 539, Daniel interpreted the handwriting on the wall and "in that night Belshazzar the Chaldean king was slain" (Dan 5:30).
In October or November 520, just after work on the Temple had been resumed, Zechariah began his ministry (1:1-6). On February 14, 519, he saw the eight night visions pertaining to Israel (1:7-6:8).
A delegation of Jews came from Bethel to Jerusalem to ask the priests and prophets about the need of continuing their mourning and fasting in commemoration of the destruction of Jerusalem. This became the occasion for an important message from God through Zechariah (chaps. 7-8).
On August 29, 520, Haggai came to exhort Jews to resume work on their Temple, which work had been left unfinished since 535 because of opposition from pagan neighbors (cf. Ezra 4:1-5). So effective was his ministry that the Jews under Zerubbabel and Joshua began to work again on September 20 (1:12-15; Ezra 5:1-2). On October 17, Haggai gave more words of encouragement to the workmen (2:1-9); and on December 18, he gave his final prophecies, including promises of great blessing for Zerubbabel, faithful governor of Judah (2:10-23).
That Ezekiel dated his prophecies according to the year of Jehoiachin's captivity indicates that he, rather than Zedekiah, was considered by the exiles to be the legitimate king of Judah. They also knew that the monarchy as they remembered it was at an end, for Jeremiah had said that no physical descendant of Jehoiachin could ever sit on the throne (22:30). This not only excluded his grandson Zerubbabel (Ezra 3:2; 1 Chron 3:19) from royal privileges, but also required that Jesus (Jer 23:5) be adopted legally by Joseph rather than be begotten by natural generation.
In spite of the initial bitterness of their captivity (cf. Psalm 137), the Jews settled down to a comparatively peaceful and prosperous life, as God had instructed (Jer 29:4-7). The majority who were content to remain in Babylon and to give of their wealth to the remnant of fifty thousand who returned to Jerusalem in 537 (Ezra 1:6).
Cyrus the Great entered Babylon (October 29, 539) and presented himself as a gracious liberator and benefactor. He reversed the cruel Assyrian and Babylonian policies by permitting transplanted populations to return to their homelands. Cyrus permitted and encouraged the Jews to return to Palestine and rebuild their Temple (2 Chron 36:22-23; Ezra 1:1-4). About one hundred and fifty years before this, Isaiah had prophesied that Cyrus would be God's chosen instrument for liberating the Jews and initiating the restoration of the Temple (Isa 44:28; 45:1-7,13). Cyrus was not a true believer (Isa 45:4), though he probably recognized the God of Israel as one of the chief deities, especially if Daniel showed him these prophecies of Isaiah, as Josephus claims (Ant. 11:1:11).
Zerubbabel laid the foundation of the second Temple (Ezra 3:8, 5:2; Zech 4:9); but in an official letter to Darius I, a Persian governor claimed that "Sheshbazzar" did this (Ezra 6:16). The name Zerubbabel's name in Babylon was Sheshbazzar (Ezra 1:8), even as Daniel's name was Belteshazzar. His father was Shealtiel (Ezra 3:2), but in 1 Chronics 3:19 he is listed as a son of Shealtiel's younger brother, Pedaiah. This means Shealtiel died childless and Pedaiah contracted a levirate marriage with his brother's widow. Because Shealtiel was the first-born son of the exiled king Jehoiachin, Zerubbabel was a Messianic link between David and Joseph (Matt 1:12).
In April or May 536, the foundation of the second Temple was laid amid great celebration. Many of the older men who had seen the first Temple before its destruction in 586 wept aloud because of the sad contrast in both size and design (Ezra 3:9-13).
Joshua (Joshua) was in the direct line of the high priests. His father, Jozadak (Ezra 3:2), was taken captive by Nebuchadnezzar (1 Chron 6:15); his grandfather Seraiah was slain at Riblah (2 Kings 25:18-21); and Seraiah's grandfather Hilkiah discovered the Book of the Law in the Temple (2 Chron 34:14) in 622. In one of Zechariah's visions (5:19), Joshua was seen representing the nation before God (Zech 3:2,9), but he did not possess the Urim and Thummim to inquire of God (Ezra 2:63).
Joshua was crowned by the prophet Zechariah to symbolize the dual priest-king office that would be held someday by Messiah (Zech 6:9-15).
Tattenai, a Persian governor, wrote to Darius I to challenge the rebuilding of the Temple. Darius found the decree of Cyrus in the library at Ecbatana and commanded Tattenai to help the Jews.
The completion of the Temple in February or March 516 may be considered the end of a special seventy-year captivity for Jerusalem and its Temple (Zech 1:12, 7:5).
Joiakim, son of Joshua, is mentioned in Nehemiah 12:10-12, and Zechariah is listed as a contemporary (Neh 12:16).
As Necho II had tried to bolster the tottering Assyrian Empire for a buffer against Babylon, so Amasis tried in vain to hinder the growth of Persian power by alliances with Croesus of Lydia and Nabonidus of Babylon. He saw both of those allies destroyed, and a few months after his own death, Egypt fell before the Persians.
Psamtik II reigned only six months before Persia, under Cambyes, attacked him. His Egyptian army was defeated at Pelusium (525), and Cambyes took the throne as the first king of the twenty-ninth Dynasty. The Persian rule of Egypt continued until Alexander the Great conquered it in 332. After his death in 323, Egypt was ruled by the Ptolemies (six are mentioned in Daniel 11:5-25) until the death of Cleopatra (30 B.C.), when the Romans took over.

# Babylonian Captivity

John C. Whitcomb (2 of 2: Chronology)

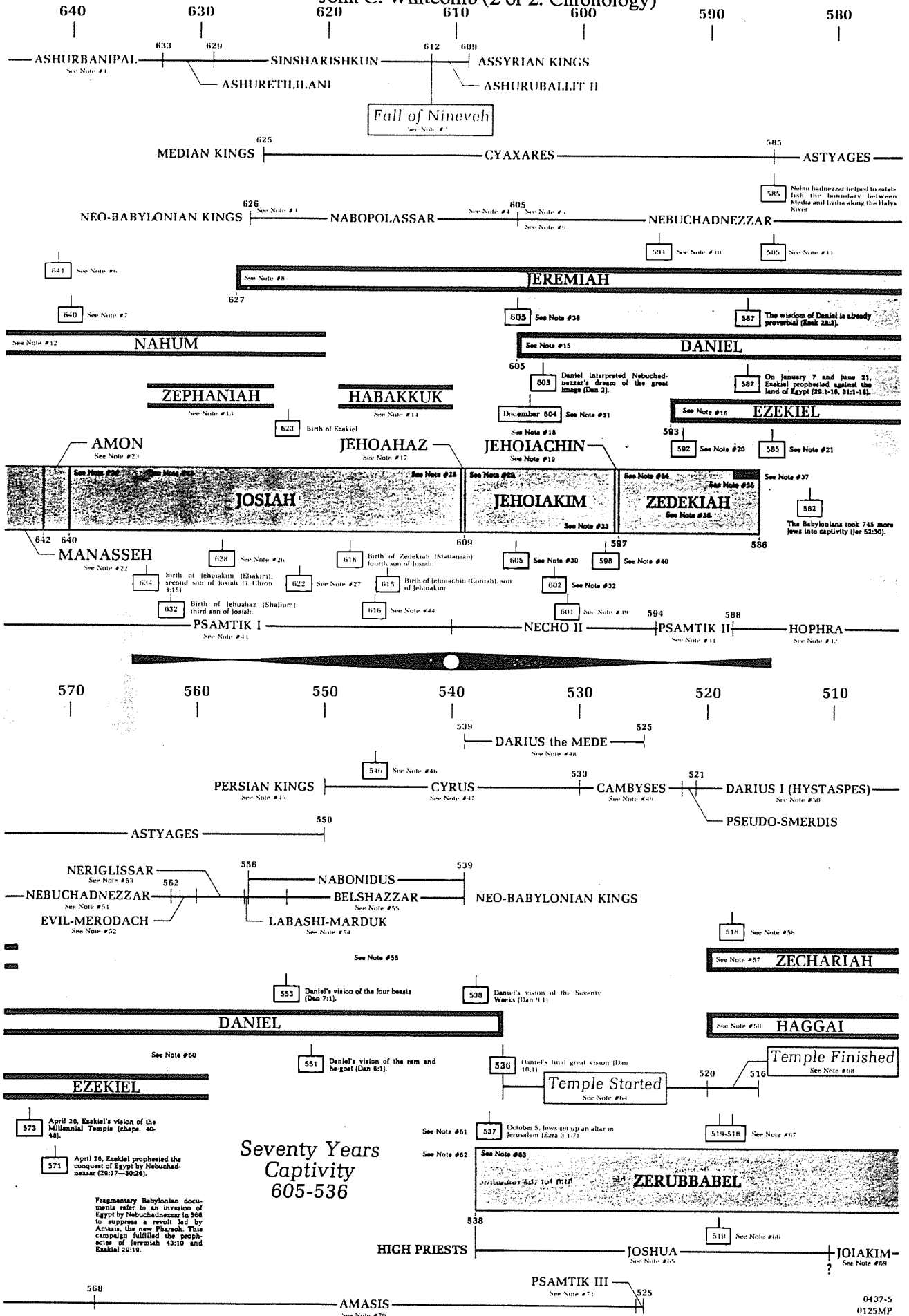

## If I Forget Thee: Does Jerusalem Really Matter to Islam?

Daniel Pipes

The architects of the Oslo peace accords understood Jerusalem's power. Fearing that even discussing the holy city's future before less combustible issues are resolved would detonate the fragile truce between Israelis and Palestinians, they tried to delay this issue to the end. But they failed: riots met the opening of a new entrance to an ancient tunnel last September and now the building of apartments on an empty plot in eastern Jerusalem has brought the negotiations to a halt. As it becomes clear that the struggle for Jerusalem will not wait, the outside world must confront the conflicting claims made by Jews and Muslims on the city that King David entered three millennia ago.

When they do, they will no doubt hear relativistic clichés to the effect that Jerusalem is "a city holy to both peoples," implying a parallel quality to the Jewish and Islamic claims to Jerusalem. But this is false. Jerusalem stands as the paramount religious city of Judaism, a place so holy that not just its soil but even its air is deemed sacred. Jews pray in its direction, mention its name constantly in prayers, close the Passover service with the wistful statement "Next year in Jerusalem," and recall the city in the blessing at the end of meals.

What about Jerusalem's role in Islam? Its significance pales next to Mecca and Medina, the twin cities where Muhammad lived and which hosted the great events of Islamic history. Jerusalem is not the place to which Muslims pray, it is not once mentioned by name in the Qur'an or in prayers, and it is directly connected to no events in Muhammad's life. The city never became a cultural center and it never served as capital of a sovereign Muslim state. Jerusalem has mattered to Muslims only intermittently over the past 13 centuries, and when it has mattered, as it does today, it has done so because of politics. Conversely, when the utility of Jerusalem expires, the passions abate and its status declines.

In AD 622, the Prophet Muhammad fled his home town of Mecca for Medina, a city with a substantial Jewish population. On arrival, if not earlier, he adopted a number of practices friendly to Jews, such as a Yom Kippur-like fast, a synagogue-like house of prayer, and kosher-style dietary laws. Muhammad also adopted the Judaic practice of facing the Temple Mount in Jerusalem during prayer; "He chose the Holy House in Jerusalem in order that the People of the Book [i.e., Jews] would be conciliated," notes At-Tabari, an early Muslim commentator on the Qur'an, "and the Jews were glad." Modern historians agree: W. Montgomery Watt, a leading biographer of Muhammad, interprets the prophet's "far-reaching concessions to Jewish feeling" as part of his "desire for a reconciliation with the Jews."

But Jews criticized the new faith and rejected Muhammad's gestures, leading Muhammad to eventually break with them, probably in early 624. The most dramatic sign of this change came in a Qur'anic passage (2:142-52) ordering the faithful no longer to pray toward Syria but toward Mecca instead. (The Qur'an and other sources only mention the direction as "Syria"; other information makes it clear that "Syria" means Jerusalem.)

This episode initiated a pattern that would be repeated many times over the succeeding centuries: Muslims take religious interest in Jerusalem because it serves them politically and when the political climate changes, their interest flags.

In the century after Muhammad's death, politics prompted the Damascus-based Umayyad dynasty, which controlled Jerusalem, to make this city sacred in Islam. Embroiled in fierce competition with a dissident leader in Mecca, the Umayyad rulers sought to diminish Arabia at Jerusalem's expense. They sponsored a genre of literature praising the "virtues of Jerusalem" and circulated accounts of the prophet's sayings or doings (called hadiths) favorable to Jerusalem. In 688-91, they built Islam's first grand structure, the Dome of the Rock, on top of the remains of the Jewish Temple.

In a particularly subtle and complex step, they even reinterpreted the Qur'an to make room for Jerusalem. The Qur'an, describing Muhammad's Night Journey (isra'), reads: "[God] takes His servant [i.e., Muhammad] by night from the Sacred Mosque to the furthest mosque." When this Qur'anic passage was first revealed, in about 621, a place called the Sacred Mosque already existed in Mecca. In contrast, the "furthest mosque" was a turn of phrase, not a place. Some early Muslims understood it as metaphorical or as a place in heaven. And if the "furthest mosque" did exist on earth,

Palestine would have seemed an unlikely location, for that region elsewhere in the Qur'an (30:1) was called "the closest land" (adna al-ard).

But in 715, the Umayyads built a mosque in Jerusalem, again right on the Temple Mount, and called it the Furthest Mosque (al-masjid al-aqsa, or Al-Aqsa Mosque). With this, the Umayyads not only post hoc inserted Jerusalem into the Qur'an but retroactively gave it a prominent role in Muhammad's life. For if the "furthest mosque" is in Jerusalem, then Muhammad's Night Journey and his subsequent ascension to heaven (mi'raj) also took place on the Temple Mount.

But, as ever, Jerusalem mattered theologically only when it mattered politically, and when the Umayyad dynasty collapsed in 750, Jerusalem fell into near-obscurity. For the next three and a half centuries, books praising the city lost favor and the construction of glorious buildings not only stopped, but existing ones fell apart (the Dome over the rock collapsed in 1016). "Learned men are few, and the Christians numerous," bemoaned a tenth-century Muslim native of Jerusalem. The rulers of the new dynasty bled Jerusalem and its region country through what F. E. Peters of New York University calls "their rapacity and their careless indifference."

By the early tenth century, notes Peters, Muslim rule over Jerusalem had an "almost casual" quality with "no particular political significance." In keeping with this near-indifference, the Crusader conquest of the city in 1099 initially aroused a mild Muslim response: "one does not detect either shock or a sense of religious loss and humiliation," notes Emmanuel Sivan of the Hebrew University, a scholar of this era.

Only as the effort to retake Jerusalem grew serious in about 1150 did Muslim leaders stress Jerusalem's importance to Islam. Once again, hadiths about Jerusalem's sanctity and books about the "virtues of Jerusalem" appeared. One hadith put words into the Prophet Muhammad's mouth saying that, after his own death, Jerusalem's falling to the infidels is the second greatest catastrophe facing Islam.

Once safely back in Muslim hands after Saladin's reconquest, however, interest in Jerusalem dropped, to the point where one of Saladin's grandsons temporarily ceded the city in 1229 to Emperor Friedrich II in return for the German's promise of military aid against his brother, a rival king. But learning that Jerusalem was back in Christian hands again provoked intense Muslim emotions; as a result, in 1244, the city was again under Muslim rule. The psychology at work here bears note: that Christian knights traveled from distant lands to make Jerusalem their capital made the city more valuable in Muslim eyes too. "It was a city strongly coveted by the enemies of the faith, and thus became, in a sort of mirror-image syndrome, dear to Muslim hearts," Sivan explains.

The city then lapsed back to its usual obscurity for nearly eight centuries. At one point, the city's entire population amounted to a miserable four thousand souls. The Temple Mount sanctuaries were abandoned and became dilapidated. Under Ottoman rule (1516-1917), Jerusalem suffered the indignity of being treated as a tax farm for non-resident, one-year (and so very rapacious) officials. The Turkish authorities raised funds by gouging European visitors, and so made little effort to promote Jerusalem's economy. The tax rolls show soap as the city's only export item. In 1611, George Sandys found that "Much lies waste; the old buildings (except a few) all ruined, the new contemptible." Gustav Flaubert of *Madame Bovary* fame visited in 1850 and found "Ruins everywhere." Mark Twain in 1867 wrote that Jerusalem "has lost all its ancient grandeur, and is become a pauper village."

In modern times, notes the Israeli scholar Hava Lazarus-Yafeh, Jerusalem "became the focus of religious and political Arab activity only at the beginning of the present century, and only because of the renewed Jewish activity in the city and Judaism's claims on the Western Wailing Wall." British rule over city, lasting from 1917 to 1948, further galvanized Muslim passion for Jerusalem. The Palestinian leader (and mufti of Jerusalem) Hajj Amin al-Husayni made the Temple Mount central to his anti-Zionist efforts, for example raising funds throughout the Arab world for the restoration of the Dome of the Rock. Arab politicians made Jerusalem a prominent destination; for example, Iraqi leaders frequently turned up, where they demonstrably prayed at Al-Aqsa and gave rousing speeches.

But when Muslims retook the Old City with its Islamic sanctuaries in 1948, they quickly lost interest in it. An initial excitement stirred when the Jordanian forces took the walled city in 1948 as evidenced by the Coptic bishop's crowning King `Abdallah as "King of Jerusalem" in November of that year but then the usual ennui [boredom] set in. The Hashemites had little affection for Jerusalem, where some



of their most devoted enemies lived and where `Abdallah himself was shot dead in 1951. In fact, the Hashemites made a concerted effort to diminish the holy city's importance in favor of their capital, Amman. Jerusalem had served as the British administrative capital, but now all government offices there (save tourism) were shut down. The Jordanians also closed some local institutions (e.g., the Arab Higher Committee) and moved others to Amman (the treasury of the Palestinian waqf, or religious endowment).

Their effort succeeded. Once again, Arab Jerusalem became an isolated provincial town, now even less important than Nablus. The economy stagnated and many thousands left Arab Jerusalem. While the population of Amman increased five-fold in the period 1948-67, Jerusalem's grew just 50 percent. Amman was chosen as the site of the country's first university as well as of the royal family's many residences. Perhaps most insulting of all, Jordanian radio broadcast the Friday prayers not from Al-Aqsa Mosque but from a mosque in Amman.

Nor was Jordan alone in ignoring Jerusalem; the city virtually disappeared from the Arab diplomatic map. No foreign Arab leader came to Jerusalem between 1948 and 1967, and even King Husayn visited only rarely.

King Faysal of Saudi Arabia often spoke after 1967 of yearning to pray in Jerusalem, yet he appears never to have bothered to pray there when he had the chance. Perhaps most remarkable is that the PLO's founding document, the Palestinian National Covenant of 1964, does not even once mention Jerusalem.

All this abruptly changed after June 1967, when the Old City came under Israeli control. As in the British period, Palestinians again made Jerusalem the centerpiece of their political program. Pictures of the Dome of the Rock turned up everywhere, from Yasir Arafat's office to the corner grocery. The PLO's 1968 Constitution described Jerusalem as "the seat of the Palestine Liberation Organization."

Nor were Palestinians alone in their renewed interest. "As during the era of the Crusaders," Lazarus-Yafeh points out, many Muslim leaders "began again to emphasize the sanctity of Jerusalem in Islamic tradition," even dusting off old hadiths to back up their claims. Jerusalem became a mainstay of Arab League and United Nations resolutions. The formerly stingy Jordanian and Saudi governments now gave munificently to the Jerusalem waqf.

As it was under the British mandate, Jerusalem has since 1967 again become the primary vehicle for mobilizing international Muslim opinion. A fire at Al-Aqsa Mosque in 1969 gave Faysal the occasion to convene twenty-five Muslim heads of state and establish the Organization of the Islamic Conference, a United Nations for Muslims. Lebanon's leading Shi`i authority regularly relies on the theme of liberating Jerusalem to inspire his own people to liberate Lebanon. Since the Islamic Revolution, Iran's 1-rial coin and 1000-rial banknote have featured the Dome of the Rock. Iranian soldiers at war with Saddam Husayn's forces in the 1980s received primitive maps marking a path through Iraq and onto Jerusalem. Ayatollah Khomeini decreed the last Friday of Ramadan as Jerusalem Day, and the holiday has served as a major occasion for anti-Israel harangues.

Since Israeli occupation, some ideologues have sought to establish the historical basis of Islamic attachment to Jerusalem by raising three main arguments, all of them historically dubious. First, they assert a Muslim connection to Jerusalem that predates the Jewish one. Ghada Talhami, a scholar at Lake Forest College, typically asserts that "There are other holy cities in Islam, but Jerusalem holds a special place in the hearts and minds of Muslims because its fate has always been intertwined with theirs."

Always? Jerusalem's founding antedated Islam by about two millennia, so how can that be? Ibrahim Hooper, national communications director for the Washington-based Council on American-Islamic Relations explains: "the Muslim attachment to Jerusalem does not begin with the prophet Muhammad, it begins with the prophets Abraham, David, Solomon and Jesus, who are also prophets in Islam." In other words, the central figures of Judaism and Christianity were really proto-Muslims.

Second, and equally anachronistic, is the claim that the Qur'an mentions Jerusalem. Hooper (and others) argue that "the Koran refers to Jerusalem by its Islamic centerpiece, al-Aqsa Mosque." But this makes no sense: a mosque built a century after the Qur'an was delivered cannot establish what a Qur'anic verse originally meant.

Third, some Muslims deny Jerusalem any importance to Jews. `Abd al- Malik Dahamshe, an Arab member of Israel's parliament, flatly stated last month that "the Western Wall is not associated with the remains of the Jewish Temple." A fundamentalist Israel Arab leader went further and announced that "It's prohibited for Jews to pray at the Western Wall." Or, in the succinct wording of a protest banner: "Jerusalem is Arab."

Despite these deafening claims that Jerusalem is essential to Islam, the religion does contain a recessive but persistent strain of anti-Jerusalem sentiment. Perhaps the most prominent adherent of this view was Ibn Taymiya (1263-1328), one of Islam's strictest and most influential religious thinkers. (The Wahhabis of Arabia are his modern-day successors.)

In an attempt to purify Islam of accretions and impieties, Ibn Taymiya dismissed the sacredness of Jerusalem as a notion deriving from Jews and Christians, and from the long-ago Umayyad rivalry with Mecca. More broadly, learned Muslims living in the years following the Crusades knew that the great publicity given to hadiths extolling Jerusalem's sanctity resulted from the Countercrusade—that is, from political exigency—and treated it warily.

Recalling that God once had Muslims direct their prayers toward Jerusalem and then turned them instead toward Mecca, some early hadiths suggested that Muslims specifically pray with away from Jerusalem, a rejection that still survives in vestigial form; he who prays in Al-Aqsa Mosque not coincidentally shows his back precisely to the Temple area toward which Jews pray.

In Jerusalem, theological and historical claims matter, serving as the functional equivalent of legal documents elsewhere. Whoever can establish a deeper and more lasting association with the city has a better chance of winning international support to rule it. In this context, the fact that politics has so long fueled the Muslim attachment to Jerusalem has two implications. First, it points to the relative weakness of the Islamic connection to the city, one that arises as much from transitory considerations of mundane need as from the immutable claims of faith.

Second, it suggests that the Muslim interest lies not so much in controlling Jerusalem as it does in denying control over the city to anyone else. Jerusalem will never be more than a secondary city for Muslims.

In contrast, Mecca is the eternal city of Islam, the place where Muslims believe Abraham nearly sacrificed Isaac's brother Ishmael and toward which Muslims turn to pray five times each day. Non-Muslims are strictly forbidden there, so it has a purely Muslim population. Mecca evokes in Muslims a feeling similar to that of Jerusalem among Jews: "Its very mention reverberates awe in Muslims' hearts," writes Abad Ahmad of the Islamic Society of Central Jersey. Very roughly speaking, what Jerusalem is to Jews, Mecca is to the Muslims. And just as Muslims rule an undivided Mecca, so Jews should rule an undivided Jerusalem.

---

The author (Daniel Pipes) is editor of the *Middle East Quarterly* and author of *The Hidden Hand: Middle East Fears of Conspiracy* (St. Martin's Press).

Originally appeared in slightly different form in *The New Republic* April 28, 1997

This essay was received courtesy of Dr. Aaron Lerner of Independent Media Review and Analysis (IMRA), imra@netvision.net.il. Views expressed are not necessarily those of IRIS or its staff.

Though this essay is substantially longer than the typical IRIS mailing, we believe its content is well worth the exception.

Jason and Leiah Elbaum

IRIS

<http://www.netaxs.com/people/iris>

# Ezra

Restoring the Temple and People								
Temple					People			
Zerubbabel					Ezra			
Chapters 1-6					Chapters 7-10			
50,000 Return					5,000 Return			
Survival					Revival			
Working					Worshipping			
538-516 BC (22 Years)					458-457 BC (1 Year)			
External Opposition: Samaritans					Internal Opposition: Intermarriage			
Return 1-2		Rebuilding 3-6			Return 7-8		Restoration 9-10	
Decree 1	Returnees 2	Begins 3	Opposed 4:1-6:12	Ends 6:13-22	Qualifi- cations & Provisions 7	Returnees & Protection 8	Inter- marriage & Lament 9	Divorces Carried Out 10

Book of Esther (58 yr gap)

**Key Word:** Temple

**Key Verse:** "... for a brief moment, the LORD our God has been gracious in leaving us a remnant and giving us a firm place in his sanctuary, and so our God gives light to our eyes and a little relief in our bondage" (Ezra 9:8)

**Summary Statement:**

The restorations of the temple and people to the land under Zerubbabel and Ezra record God's faithfulness and mercy in fulfilling His promise of restoration to encourage the remnant in true temple worship and covenant obedience.

**Application:**

Restoration to God for the repentant believer requires action.

# Ezra

## Introduction

**I. Title** Ezra and Nehemiah originally formed a single book according to Josephus (*Against Apion* 1.8), Jerome (*Preface to the Commentary on Galatians*), and the Talmud (*Baba Bathra* 15a). The Hebrew Bible also has the two books together under the title Ezra Nehemiah (עֶזְרָא נְחֵמְיָהּ *ezra' nehemeyah*). However, the repetition of Ezra 2 in Nehemiah 7 may indicate that the two were originally separate works. Ezra means "help, succour, assistance" (BDB 740d 1) and Nehemiah means "Yahweh comforts" (BDB 637c 3). Once again the names are significant in that Ezra's ministry enabled the Jews to return to the land and reconsecrate themselves while Nehemiah functioned as God's comfort through building Jerusalem's protective wall.

## II. Authorship

- A. External Evidence: The Jewish talmudic tradition has long held that Ezra authored this book which bears his name.
- B. Internal Evidence: In one section (7:27—9:15) the author refers to himself in the first person. What makes this significant is the fact that in all likelihood Ezra was not even born when the events of chapters 1—6 took place (538-516 BC) since he is first introduced in 7:1 (458 BC). As in Chronicles, the book has a strong priestly emphasis, and Ezra was in direct descent from Aaron through Eleazer, Phineas, and Zadok (7:1-5). The Apocrypha states that Ezra had access to the library of documents gathered by Nehemiah (2 Macc. 2:13-15) which furnished the material to write Ezra 1—6 as well as the Book of Chronicles (*TTTB*, 117); however, Nehemiah lived in Babylon until his arrival in Jerusalem in 444 BC so Ezra either used Nehemiah's documents later than 444 BC or else the Apocrypha is inaccurate (cf. Date below).

## III. Circumstances

- A. Date: The events of Ezra 7—10 in which Ezra had part occurred in 458-457 BC. Also, Ezra was contemporary of Nehemiah (Neh. 8:1-9; 12:36), who arrived in Jerusalem in 444 BC. A likely date of composition may be between these two dates, placing the writing at approximately 450 BC (Martin, *BKC*, 1:651).

However, the Book of Ezra itself covers two distinct time periods separated by 58 years. Ezra 1—6 relates the story of Zerubbabel (538-516 BC) while Ezra 7—10 is mostly an autobiographical account of Ezra which begins six decades later (458-457 BC). During the period covered by the Book of Ezra three other prominent non-biblical leaders lived (*TTTB*, 117): Gautama Buddha in India (ca. 560-480 BC), Confucius in China (551-479 BC), and Socrates in Greece (470-399 BC).

- B. Recipients: Ezra's first readers comprised Jews who had recently returned to Israel from Persia and the grandchildren and great-grandchildren of those who returned from Babylon a century earlier.
- C. Occasion: Ezra continues the account of the Jewish history recorded in Second Chronicles. The Chronicles record how God was faithful in fulfilling His promise of *judgment* for Judah's sin; Ezra records how God was faithful to His promise of *restoration* after seventy years as prophesied by Jeremiah (Jer. 25:11-12; 29:10). Ezra's account of this restoration served to exhort the returnees to follow the LORD wholeheartedly—especially in true temple worship and covenant obedience. This emphasis was much needed as the Book of Malachi sadly reports deplorable conditions at this same time (e.g., intermarriage, ritualism, etc.).

## IV. Characteristics

- A. Ezra records the first events following the Babylonian Exile, but only in a selective sense as a 58 year gap separates chapters 1—6 and 7—10. The book of Esther occurs during this gap.

- B. Ezra is one of the few books of Scripture that was originally written in two languages (the Book of Daniel is another). Almost one fourth (67 of 280 verses) is written in Aramaic with the majority in Hebrew. This material (4:8—6:18; 7:12-26) is Aramaic because it mainly comprises official correspondence for which Aramaic was the standard language of the day (Martin, *BKC*, 1:652).
- C. The events in the restoration of Israel under Ezra and Nehemiah related directly to God's purposes for Israel as stated in the promise to Abraham (Gen. 12:1-3).
- 1) Events: The events of the restoration revolved around the three separate returns to the land from Babylon (see the charts in these class notes beginning on p. 296).
    - a) The first return under Zerubbabel (538 BC) involved about 50,000 Jews who came back to the land to rebuild the temple as a result of Cyrus' decree (cf. Ezra 1–6). They quickly rebuilt the altar and re-instituted sacrifices, and then began rebuilding the temple (536 BC). However, opposition from Tattenai and others halted the work for 16 years until it resumed in 520 BC and was finally finished in 516 BC. The prophets Zechariah and Haggai also ministered at this time. Their exhortations to rebuild the temple contributed significantly to its reconstruction.
    - b) The second return under Ezra (458 BC) brought back about 5,000 Jews in the reign of Artaxerxes (Ezra 7–8). Ezra restored the people by leading them to obey the Law through undoing their practice of intermarriage with foreign women (Ezra 9–10). He restored the people's faith in God by teaching and preaching the Law of Moses, which led to a national revival.
    - c) The third return under Nehemiah (444 BC) to rebuild the walls of Jerusalem mainly revolved around Nehemiah himself, as the number of Jews with him is never recorded (cf. Book of Nehemiah). His return under Artaxerxes rallied the people to work together despite opposition from Sanballat, Tobias, and Gershem the Arab so that the entire wall of Jerusalem was rebuilt in a mere 52 days. Nehemiah then organized the defense of the city, led in a recommitment to Sabbath observance, and enacted a process by which Jerusalem would be repopulated to defend it and the temple from attack. He, too, had to deal with the problem of intermarriage that Ezra addressed less than two decades earlier (Neh. 13). The Book of Malachi also records the deplorable state of the temple at this time in which sacrificial ritual had replaced genuine heart commitment to Yahweh. Nehemiah's selfless example also rebuked the people's exacting interest from their fellow Israelites in violation of the Law.
  - 2) Relationship to the Abrahamic Covenant: The restoration era is important in that without a return to the land, the Abrahamic Covenant could never be fulfilled.
    - a) God promised Abraham that his descendants would occupy the land from the River of Egypt to the Euphrates (Gen. 15:18), yet Israel in Babylon was living outside of these specified boundaries. The nation needed to return to the land in order for the land promises to be fulfilled. Jeremiah 25:11-12 also promised a restoration to the land.
    - b) The Messiah had already been prophesied to be born in Bethlehem (Micah 5:2). In God's own prophetic timetable as seen in Daniel 9:25-26, the nation needed to return to the land in order for this seed aspect of the Abrahamic Covenant to be fulfilled by the prophesied time of Christ's birth. Also, Jesus offered the kingdom during His earthly ministry, which would not have been possible apart from a return to the land.
    - c) The books of Ezra and Nehemiah also relate the problem of intermarriage (see above). It was vital to put away this sin so that Israel might keep the purity of the Davidic line to fulfill the seed promises originally given to Abraham. Had Ezra and Nehemiah not taken such drastic measures to stop intermarriage, there would have been no guarantee that the Messianic King was from the lineage of David (cf. Matt. 1; Luke 3).

## Argument

The Book of Ezra evidences a keen interest in the temple as it continues the account left off at the end of Second Chronicles. Unfortunately, the remnant who returned did not convey as strong a commitment to the covenant and temple as one would expect. Therefore, Ezra records the restoration of the temple under Zerubbabel (chs. 1—6) and the restoration of the people to their covenant obligations under Ezra (chs. 7—10) to encourage the remnant in true temple worship and covenant obedience.

## Synthesis

### Restoring the temple and people

### partial fulfillment of land promise

<b>1—6</b>	<b>Temple—Zerubbabel</b>
1—2	Return
1	Decree
2	Returnees—50,000
3—6	Rebuilding
3	Begins
4:1—6:12	Opposed
4:1-23	Summarized
4:24	Interrupted
5:1-2	Zechariah/Haggai
5:3—6:12	Tattenai humiliated
6:13-22	Ends
<b>7—10</b>	<b>People—Ezra</b>
7—8	Return
7:1-10	Qualifications
7:11-28	Provisions
8:1-14	Returnees—5,000
8:15-36	Protection
9—10	Restoration
9:1-2	Intermarriage
9:3-15	Lament
10	Divorces

## Outline

### Summary Statement for the Book

*The restorations of the temple and people to the land under Zerubbabel and Ezra record God's faithfulness and mercy in fulfilling His promise of restoration to encourage the remnant in true temple worship and covenant obedience.*

- I. (Chs. 1—6) The rebuilding of the temple in the first return under Zerubbabel with 50,000 Jews encourages the remnant to worship only at the temple because of God's faithfulness in fulfilling His promise of restoration (538 BC).
  - A. (Chs. 1—2) The first return under Zerubbabel with 50,000 Jews is recorded as evidence of God's faithfulness in fulfilling His promise of restoration.
    1. (Ch. 1) Cyrus of Persia proclaims that all Jews in Babylon may return to Jerusalem to rebuild the temple and makes financial provisions for returnees as evidence of God's ability to fulfill His promise of restoration—even through a pagan king!
    2. (Ch. 2) The list of returning exiles reveals that 50,000 Jews return and give freewill offerings toward the reconstruction of the temple as evidence of God's faithfulness in fulfilling His promise of restoration.

- B. (Chs. 3–6) The rebuilding of the temple over a twenty year period despite great opposition demonstrates God's commitment to having His temple rebuilt to encourage the remnant to worship only at the temple—not at the high places which caused the exile.
1. (Ch. 3) The temple rebuilding begins by rebuilding the altar and foundation and the resumption of sacrifices, which shows God's commitment to worship at the temple rather than the high places.
  2. (4:1–6:12) The temple rebuilding is opposed by enemies of Judah which halts the project for 16 years until Zechariah and Haggai encourage the people to continue, which God rewards by having the key enemy guarantee the project's success!
    - a. (4:1-5) Opposition to temple rebuilding (ca. 536 BC under Cyrus) interrupted the work for 16 years (536-520 BC).
    - b. (4:6-23) A parenthetical summary of later opposition to rebuilding the walls (ca. 484 under Xerxes and ca. 444 BC under Artaxerxes) shows the remnant that while their enemies continually opposed them, God did eventually give them success.
    - c. (4:24) The temple rebuilding is interrupted for 16 years (536-520 BC) due to the opposition of Jews intermarried with pagans and worshipping other gods.
    - d. (5:1-2) Zechariah and Haggai successfully encourage the people to continue rebuilding the temple despite opposition (520 BC).
    - e. (5:3–6:12) The opposition of Tattenai towards the temple rebuilding backfires as Darius appoints him to make sure the work is funded and completed as evidence of God's workings to provide a house in which He is to be properly worshiped.
  3. (6:13-22) The completion of the temple rebuilding in 516 BC (twenty years after its beginning) is commemorated with a special dedication and Passover observance.

**II. (Chs. 7–10) The reformation of the people in the second return under Ezra with 5,000 Jews is recorded to encourage the remnant to fulfill its covenant obligations on the basis of God's mercy (458 BC).**

- A. (Chs. 7–8) The second return under Ezra the priest with 5,000 Jews is recorded as evidence of God's merciful protection upon all who trust Him.
1. (7:1-10) Ezra's qualifications to lead more returnees back to Jerusalem are cited to show God's leading in his life as priest for the spiritual restoration of the remnant.
    - a. (7:1-5) Ezra was a priest.
    - b. (7:6a) Ezra was a teacher.
    - c. (7:6b-9) Ezra experienced the hand of God on his life.
    - d. (7:10) Ezra made his priority the study, obedience, and teaching of the law.
  2. (7:11-28) Ezra records God's provision for the return through King Artaxerxes, who supplies money, authority to Ezra for teaching and governing, and exemption of taxes for temple workers, to remind the exiles of God's blessing upon their obedience.
  3. (8:1-14) Returnees include 18 family heads, 1496 other men, plus women and children, totaling about 5,000—a much smaller group than the 50,000 who returned with Zerubbabel 80 years earlier.
  4. (8:15-36) God protects the returnees because of their spiritual preparation for the return through the addition of 258 Levites for temple leadership and the celebration of a fast, recorded to demonstrate God's hand upon all who trust Him.

B. (Chs. 9–10) Ezra's restoration of the people through their separation from foreign wives is recorded to exhort Israel to live according to the covenant.

1. (9:1-2) Ezra learns that many leaders of the community have enticed the nation to sin by intermarrying pagan women in direct violation of the Law (Gen. 24:3; 26:34-35; 28:1, 2, 8; Exod. 34:16; Deut. 7:1-2; 20:17-18; cf. Judg. 3:5ff.; 1 Kings 11).
2. (9:3-15) Ezra laments the intermarriage and confesses to God His faithfulness in contrast to Israel's unfaithfulness to model for the people the proper response to sin's which are serious enough to threaten the covenant community.

Are Ezra and Nehemiah functioning primarily to teach us proper leadership style? Then whom should you follow?

- ◆ Intermarriage lead Ezra to pull out his own hair (Ezra 9:13)
- ◆ Intermarriage lead Nehemiah to pull out others' hair (Neh. 13:25)!

3. (Ch. 10) The initiation by the leaders that Israelites divorce their foreign wives is carried out faithfully for 113 men to exhort Israel to live according to the covenant.
  - a. (10:1-17) After all Israel laments the sin of intermarriage, the leaders who initiate the idea to divorce all foreign wives fulfill their vow to do so.
  - b. (10:18-44) The list of men required to divorce pagan foreign wives includes priests, Levites, and common people to show the great extent in which this sin had pervaded the holy nation as vindication for such a drastic action as divorce.

\*\*\*\*\*

### God's Approval of Divorce under Ezra

*Issue: How could God approve of divorce here when He elsewhere disapproves of it and even says clearly, "I hate divorce" (Mal. 2:16; cf. Matt. 19:8)?*

1. The text doesn't specifically say that God approved of divorce. One solution could have been for the 113 men to leave the community with their families. However, for the sake of argument, the other reasons below are offered...
2. The account serves to illustrate that maintaining the purity of the covenant people of God was more important than even keeping some individual families intact (especially families destined to destroy the messianic line).
3. Though 113 men may seem a small number, this included leaders of the people, so intermarriage was certainly going to spread further to the common people as had happened in the Jewish community in Egypt and the kingdom of Israel to the north.





## Returns from Exile

John H. Walton, *Chronological and Background Charts of the Old Testament*, 35 and John A. Martin, "Ezra," in *The Bible Knowledge Commentary*, 1:652, adapted

RETURN	FIRST	SECOND	THIRD
Reference	Ezra 1-6	Ezra 7-10	Nehemiah 1-13
Date	538 B.C.	458 B.C.	444 B.C.
Leaders	Sheshbazzar Zerubbabel Jeshua	Ezra	Nehemiah
Persian King	Cyrus	Artaxerxes Longimanus	Artaxerxes Longimanus
Elements of the Decree	As many as wished to could return. Temple could be rebuilt, partially financed by royal treasury. Vessels returned.	As many as wished to could return. Finances provided by royal treasury. Allowed to have own civil magistrates.	Allowed to rebuild the wall
Number Returning	42,360 <u>7,337</u> (servants) 49,697	1,500 men 38 Levites <u>220</u> helpers 1,758 + women + children = 5,000 ?	Unknown
Events, Accomplishments, and Problems	Temple begun; sacrifices made and Feast of Tabernacles celebrated. Samaritans made trouble, and work ceased until 520. Temple completed in 516.	Problems with inter-marriage	Wall rebuilt in 52 days, despite opposition from Sanballat, Tobiah, and Geshem. Walls dedicated and Law read.

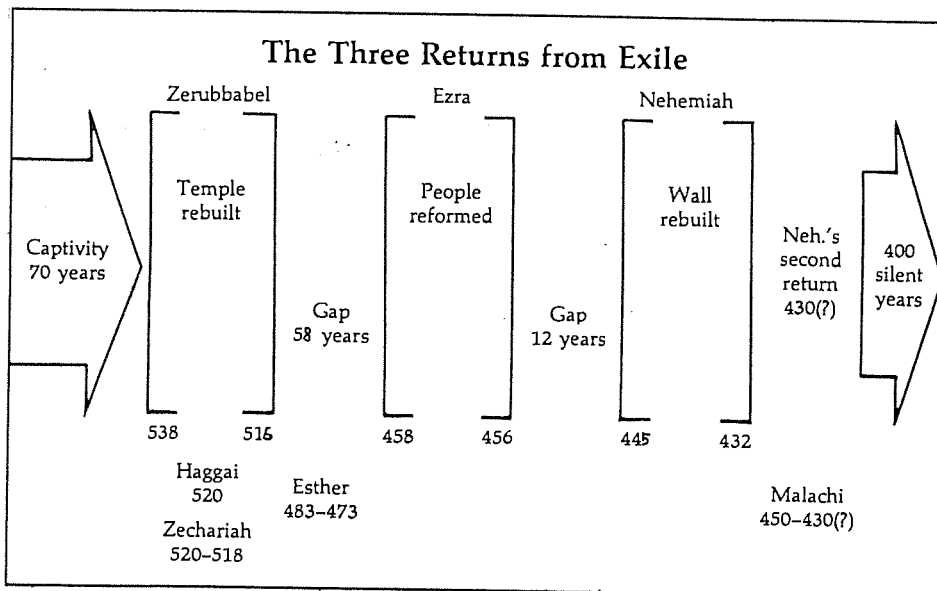

**Chronological Sequence in the Book of Ezra**  
 John H. Walton, *Chronological and Background Charts of the OT*, 2d ed., 36

# Chronological Sequence in the Book of Ezra

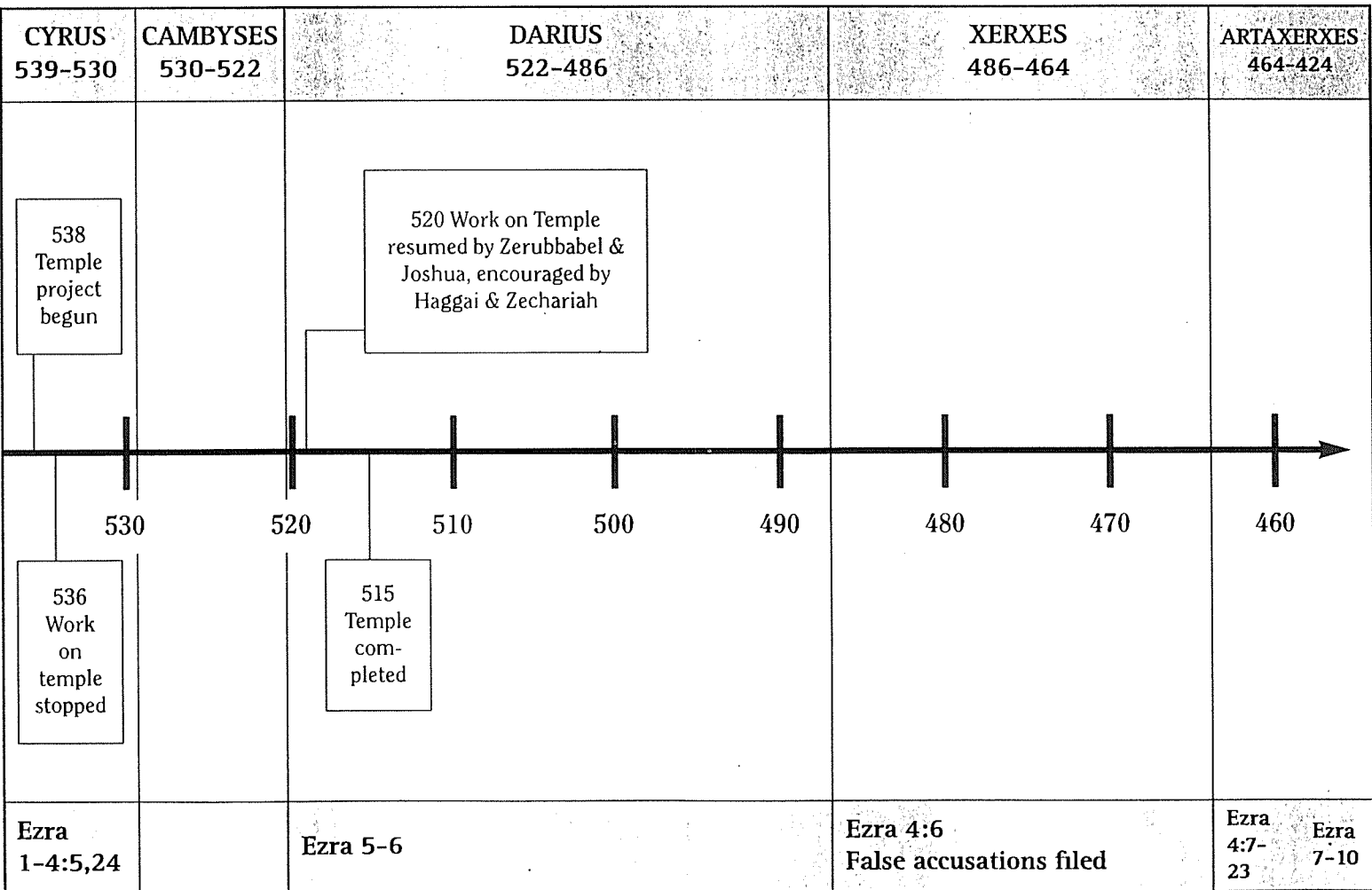

# Chronology of Ezra-Nehemiah

*The Bible Visual Resource Book, 93*

Ezra

## Chronology: Ezra-Nehemiah

Dates below are given according to a Nisan-to-Nisan Jewish calendar (see chart on "Hebrew Calendar," p. 102).

Roman numerals represent months; Arabic numerals represent days.

540 B.C.

	YEAR	MONTH	DAY	EVENT	REFERENCE
530	539 B.C.	Oct.	12	Capture of Babylon	Da 5:30
	538 to 537	Mar. to Mar.	24 to 11	Cyrus's first year	Ezr 1:1-4
520	537(?)			Return under Sheshbazzar	Ezr 1:11
	537	VII		Building of altar	Ezr 3:1
510	536	II		Work on temple begun	Ezr 3:8
	536-530			Opposition during Cyrus's reign	Ezr 4:1-5
	530-520			Work on temple ceased	Ezr 4:24
500	520	VI =Sept.	24 to 21	Work on temple renewed under Darius	Ezr 5:2; Hag 1:14
	516	XII =Mar.	3 to 12	Temple completed	Ezr 6:15
490	<hr/>				
480	458	I =Apr.	1 to 8	Ezra departs from Babylon	Ezr 7:6-9
		V =Aug.	1 to 4	Ezra arrives in Jerusalem	Ezr 7:8-9
470		IX =Dec.	20 to 19	People assemble	Ezr 10:9
		X =Dec.	1 to 29	Committee begins investigation	Ezr 10:16
460	457	I =Mar.	1 to 27	Committee ends investigation	Ezr 10:17
450	445	Apr.	13	20th year of Artaxerxes I	Ne 1:1
	444	to Apr.	2		
440	445	I =Mar.-Apr.		Nehemiah approaches king	Ne 2:1
		Aug.(?)		Nehemiah arrives in Jerusalem	Ne 2:11
		VI =Oct.	25 to 2	Completion of wall	Ne 6:15
430 B.C.		VII =Oct. to Nov.	8 to 5	Public assembly	Ne 7:73-8:1
		VII =Oct.	15-22 to 22-28	Feast of Tabernacles	Ne 8:14
		VII =Oct.	24 to 30	Fast	Ne 9:1
	433	Apr.	1	32nd year of Artaxerxes;	Ne 5:14; 13:6
	432	to Apr.	19	Nehemiah's recall and return	

# Return from Exile and Zerubbabel's Temple

The Bible Visual Resource Book, 95

Ezra

## Return from Exile

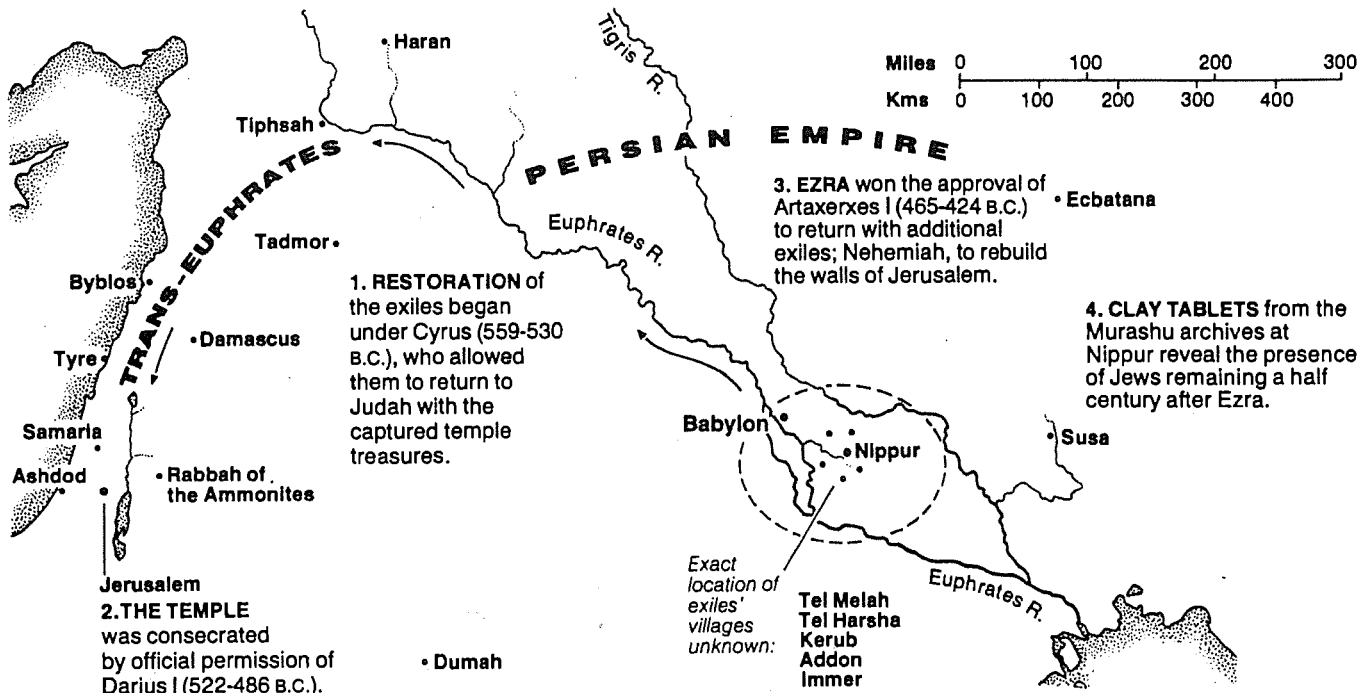

## Zerubbabel's Temple

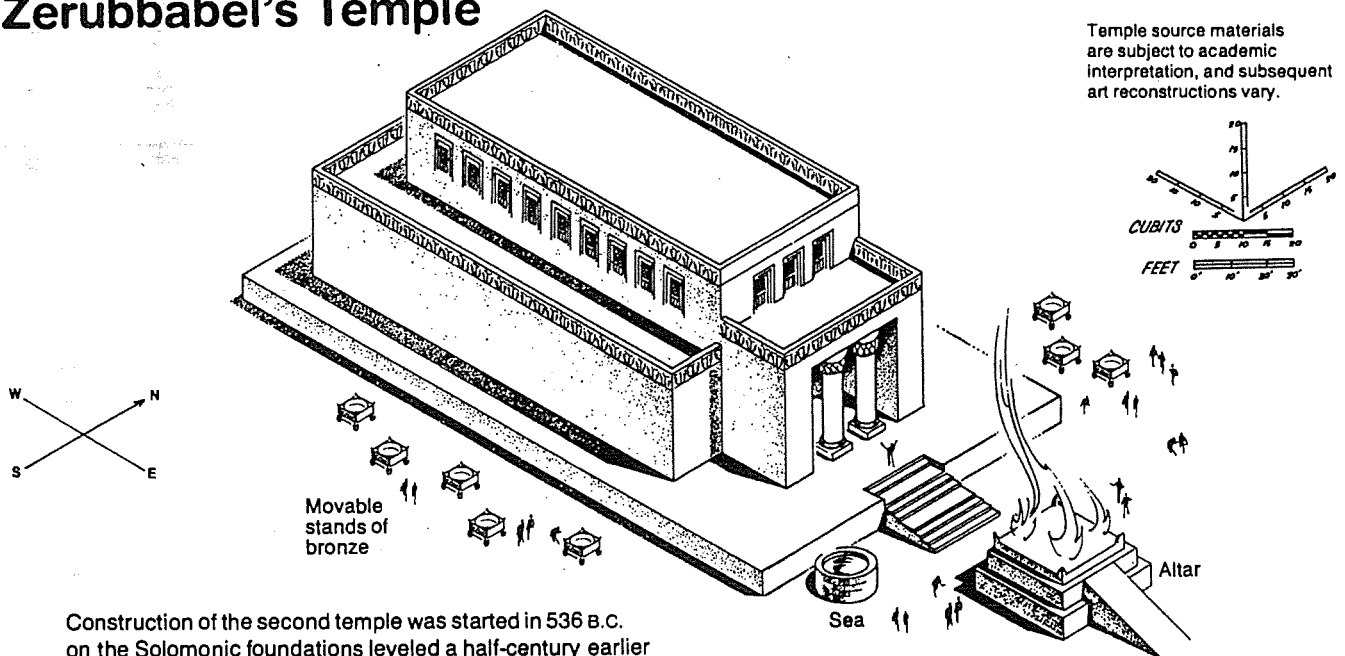

Construction of the second temple was started in 536 B.C. on the Solomonic foundations leveled a half-century earlier by the Babylonians. People who remembered the earlier temple wept at the comparison (Ezr 3:12). Not until 516 B.C., the 6th year of the Persian emperor Darius I (522-486), was the temple finally completed at the urging of Haggai and Zechariah (Ezr 6:13-15).

Archaeological evidence confirms that the Persian period in Palestine was a comparatively impoverished one in terms of material culture. Later Aramaic documents from Elephantine in Upper Egypt illustrate the official process of gaining permission to construct a Jewish place of worship, and the opposition engendered by the presence of various foes during this period.

Of the temple and its construction, little is known. Among the few contemporary buildings, the Persian palace at Lachish and the Tobiad monument at Iraq el-Amir may be compared in terms of technique.

Unlike the more famous structures razed in 586 B.C. and A.D. 70, the temple begun by Zerubbabel suffered no major hostile destruction, but was gradually repaired and reconstructed over a long period. Eventually it was replaced entirely by Herod's magnificent edifice.

## My Family is My God's Business

*Ezra 9 Monologue*

**Topic:** Worldliness  
**Subject:** Want a pure church?  
**Complement:** Weed out pagan influences in your own life first!  
**Purpose:** The listeners will rid themselves of ungodly influences that wreck their own spiritual lives and eventually that of the church

Note: The monologue setting is Ezra appearing after having come back to life and living in Singapore for some time (unspecified length).

**INTRO** Shalom. Baruchi Adonai. You probably know that "Shalom" means "welcome" or  
**Heb.** "peace" and "baruchi Adonai" means "bless the Lord." Since I have been in your land I  
**OXO** have not heard your people speak these Hebrew words. Do you not know Hebrew? Surely  
**OOO** you do! You say "hallelujah" instead of "praise the Lord," you say "amen."

**Ezra** I suppose I should first introduce myself. I am Ezra, the son of Seraiah. My ancestry goes all the way back to Zadok and even further back to Aaron himself. You will remember that all descendents of Aaron were priests, so I am no exception.

**Priest** King David divided the priesthood into 26 divisions, each of which served for two weeks a year at the temple in Jerusalem. But the other 50 weeks we lived in separate towns around the country to teach the children of Israel to live a separated life unto Jehovah. This is why I do not wear the white priestly tunic today, for this is how I dressed most of the year except for temple service.

**BKGD** I wish I could say that we were always faithful to our high calling of teaching, but we were  
**Exile** not. In fact, the priests themselves often followed other gods and led Israel *away* from the Lord rather than *to* Him. This went on for so many hundreds of years that God's patience  
**OOO** finally wore thin and he raised up two powers to judge His people. The Assyrians  
**XOO** conquered the northern part of our country and the Babylonians ravaged the south, including Jerusalem. This destroyed the very heart of Israel—the temple, which laid in ruins for 70 years.

**Return** Yet God, in His own gracious way, brought our people back to the land. Zerubbabel led 50,000 Jews back to Jerusalem to rebuild the temple on its rightful spot, then 57 years later the Lord used me to bring another 5,000 back. If you paid attention to the numbers I just gave, you would have noticed that I was only able to bring 10% of what Zerubbabel brought. And considering that the Jews had lived in Babylon for almost 130 years, this was a very small amount of Jews who returned.

**Why so few** "Why so few?" I remember asking. At the beginning of the exile, the prophet Jeremiah had advised us that we would be there for 70 years. He said that we should plant vineyards, marry, and build houses to stay a while. Perhaps we took Jeremiah too literally. My people began businesses—very profitable ones—but when the call came two or three generations later to go to a land of ruins, few responded. In my age we enjoyed the comforts of this life, which sapped our spiritual energy. I suppose that by now, after all the centuries, you have learned not to seek comforts over the Lord though.

Settle      Anyway, we did return, despite our small number. God gave us safe passage to Jerusalem, where we offered sacrifices and began to get settled into our homes.

TEXT  
Kidron      When we had been there for a little over four months, one afternoon I was sitting on the roof of my newly made home, looking out eastward across the Kidron Valley. I remember thinking about how the Babylonian armies had crossed over the Mount of Olives in front of me, ruthlessly slaughtering our people. On the south end of the Mount of Olives were some ruins from Solomon's era 500 years before. Those destroyed buildings housed Solomon's 700 wives and 300 porcupines—I mean concubines. I thanked the Lord that the intermarriage with the pagans that had devastated Solomon's empire was behind us—we'd never repeat that mistake again. We were too smart now.

OOO  
OXO

Report  
9:1a      But then I heard some men talking and looked up the hill to my left—up the City of David. I saw some of my trusted friends approaching my house, so I hurried down to meet them. Bigthani was the first to speak, "Ezra, I have terrible news to report. The people of Israel, including the priests and the Levites, have not kept themselves separate from the neighboring peoples with their detestable practices, like those of the Canaanites, Hittites, Perizzites, Jebusites, Ammonites, Moabites, Egyptians and Amorites."

Badal      I paused, bowed my head, and wondered what they meant. They used the word *badal*, saying that the people neglected to be "divided or separated" from pagans. This immediately reminded me of how Moses wrote in the creation account that "God separated the light from the darkness." Then I remembered that the Lord used the same word for setting apart the Levites to God for special service. What could these leaders mean that our people were not "separate"? Separate in what sense? Hopefully they only meant that some had illegal business deals going with pagans or that someone was lured into a questionable celebration.

Child  
Sac.      The men had said that Israel was involved in *practices* of eight pagan peoples, most of whom God had already destroyed by this time. I knew what "detestable practices" meant, for behind me in the Hinnom Valley many Israelite children had been sacrificed to the god Molech. Could it be that this pagan practice has again returned to Israel? But how?

Inter-  
marry  
9:2      The men's explanation confirmed my worst fears. They said that some of these priests and Levites had "taken some of their daughters as wives for themselves and their sons, and have mingled the holy race with the peoples around them. And the leaders and officials led the way in this unfaithfulness."

Tunic  
9:3      I couldn't believe my ears! Without even a thought, I tore my tunic and cloak. Most of the time, those in grief in my land only tear their tunic, but my distress so overwhelmed me that I tore the overcoat or cloak as well. I yanked out hair from my head—I don't ever remember doing this in my life—and grabbed clutches of hair even from my beard. Exhausted and distressed, I sat down appalled.

Crowd  
9:4-5;  
10:1      A crowd of pious Jews gathered around me and said nothing for several hours. I said so little too as I was in such dire agony from our sin. Occasionally I would lift my head and say something, but then at the evening sacrifice I lifted my hands publicly and prayed in anguish. I confessed the sin of my people, throwing myself down in agony before the Lord, tears streaming down my face.

WHY  
OXO  
OOO      Word soon spread around the community about my actions. But Sheconiah said that some of the people were saying, "But what was so bad about Jews intermarrying with pagans? Isn't God the God of all people? Can the Lord who created everyone really be a racist?"

Isn't he at all tolerant? Besides, so few Jewish women have returned from Babylon that there's not enough godly women to go around!"

- 1  
History "Have you no sense of history?" I told them. "Abraham made Isaac swear never to marry a Canaanite woman. Isaac obeyed and convinced his son Jacob to do the same, which provided our twelve tribes. Jacob traveled all the way back to Mesopotamia for a legitimate wife, Rachel. But his brother Esau spitefully disregarded this by marrying a Hittite, and their mixed-breed Edomites plague us to this day. Intermarriage gave us the terrible cycles of the judges. Do we want that again? And even our wisest and richest king—Solomon himself—went astray by intermarriage! Are you smarter than Solomon?"
- 2  
Law The law of Moses was very clear on this matter, "Do not marry with [the peoples of the lands around you.] Do not give your daughters to their sons or take their daughters for your sons." We have spurned the statutes of Jehovah God!
- 3  
Race One phrase stuck out from all the grievous words the men had said: "they have mingled the holy race." This meant that the Messianic line itself was endangered. God had said that the Messiah would descend from the tribe of Judah. Here we were, in the land of Judah ourselves, with so few men of Judah. The thought struck me that this type of sin could pollute the very bloodline that we were to protect for our Messiah!
- EI Do you people here today see why I was so grieved? It wasn't that it was simply an individual sin. I've heard people say, "My family is my business." How arrogant! No, my family is God's business. And my family is Israel's business. We are a corporate community, so the sin of one will affect the entire group.
- APPL Is it not so with you in this assembly? You too struggle with the peril of prosperity. You too wrestle with this temptation to pursue other gods, although these gods are more carefully disguised than in my age. You too are tempted to intermarry. And you too must watch the influences in your life.
- OOX  
OOO
- MLL I should point out, though, that my grief at the intermarriage actually went beyond husband-wife relationships. My point was that any pagan influence allowed in the home can destroy the entire assembly as well as the individual home. When we allow ungodly forces to work within our homes, we plant the seeds of destruction for the whole godly community. Want a pure church? Weed out pagan influences in your own life first!
- OXO  
OOO
- "No  
Pagans  
here" In my short sojourn in your land, I have noticed a peculiar thing among those calling themselves Christians. Many would never marry a pagan, many even say they would never even allow a pagan to enter their homes. But I know that there are literally hundreds of murders, numerous incidents of sexual immorality, and an abundance of pagan philosophies within countless Christian Singaporean homes!
- T.V. Many here do not believe me, but it is true. This can be observed any day in a little box inside the living room of nearly every home. What a strange name— "living room"—for a place where so much *dying* takes place! The kind of people whom Christian parents would never invite for dinner are allowed to have free reign on this picture window.
- Concl. Will we allow paganism into our homes? I pray we will not! Whether through marriage, friends, or even games or a pagan picture box. The whole Israelite community was grieved at its sin of inviting disaster upon the land. With us Jews, individual sin became family sin, and family sin became community sin that nearly obliterated our race. It is the same with you. But you can learn from the mistakes of my people. I know you will.

# Nehemiah

Restoring the Walls and People									
Walls					People				
Chapters 1-7					Chapters 8-13				
Construction					Instruction				
Political					Spiritual				
Return 1-2		Rebuilding 3-7			Renewal 8-10			Reforms 11-13	
Persia Prayer 1	Jerusalem Inspection 2	Dele- gation 3	Opposed/ Finished 4-6	Organ- ized 7	Convic- tion 8	Confes- sion 9	Cove- nant 10	Resettle- ment & Dedication 11-12	Sabbath & Intermarriage Reforms 13
-----52 days (6:15)-----								425 BC? 420 BC?	
445-433 BC								13:6a 13:6b	

**Key Word:** Walls

**Key Verse:** “So the wall was completed on the twenty-fifth of Elul, in fifty-two days. When all our enemies heard about this and all the surrounding nations saw it, our enemies lost their self-confidence, because they realized that this work had been done with the help of our God” (Nehemiah 6:15-16)

**Summary Statement:**

The restorations of the walls and people in the land under Nehemiah record God's faithfulness to His promise of restoration to encourage the remnant in covenant obedience rooted in temple worship at Jerusalem.

**Application:**

Our completing God’s projects should lead us to further obedience.



# Nehemiah

## Introduction

**I. Title** Ezra and Nehemiah originally formed a single book according to Josephus (*Against Apion* 1.8), Jerome (*Preface to the Commentary on Galatians*), and the Talmud (*Baba Bathra* 15a). The Hebrew Bible also has the two books together under the title Ezra Nehemiah (עֶזְרָא וְנְחֵמְיָהוּ *ezra' nehemeyah*). However, the repetition of Ezra 2 in Nehemiah 7 may indicate that the two were originally separate works. Ezra means "help, succour, assistance" (BDB 740d 1) and Nehemiah means "Yahweh comforts" (BDB 637c 3). Once again the names are significant in that Ezra's ministry enabled the Jews to return to the land and reconsecrate themselves while Nehemiah functioned as God's comfort through building Jerusalem's protective wall.

## II. Authorship

- A. **External Evidence:** The Book of Nehemiah has long been considered as being named after its author and chief character, Nehemiah himself.
- B. **Internal Evidence:** The inspired title of the book reads, "The Words of Nehemiah, Son of Hacaliah" (1:1) and much of the content appears in the first person (1:1–7:5; 12:27–43; 13:2b–31), making it clear that Nehemiah recorded this book. Some believe the third person sections (7:6–12:26; 12:44–13:2a) were written by Ezra since Nehemiah was absent for these events as he was in Babylon during this time (13:6). Nehemiah 7:5–73 is nearly identical to Ezra 2:1–70, but both lists probably were derived from another record of the same period (*TTTB*, 124).

Nothing is known of Nehemiah's childhood, youth, or family background since the account opens with him as an adult serving King Artaxerxes of Persia. The text does reveal that his father's name was Hacaliah (1:1) and he had a brother named Hanani (1:2), but this is of little help as these men and Nehemiah are not mentioned elsewhere in Scripture. The "Nehemiah" of Ezra 2:2; Nehemiah 7:7 (in 538 BC) must have been another man of the same name as he came to Judah 90 years before the Nehemiah of the book that bears his name (who arrived in 445 BC). What is known of this Nehemiah is his prayerfulness, diligence, intellectual capabilities, emotional maturity, spiritual status, and wisdom shown in the high position of cup-bearer granted to him by the king of Persia.

## III. Circumstances

- A. **Date:** Nehemiah left Persia in the twentieth year of Artaxerxes (2:1; 445 BC) and returned to the king in his thirty-second year (13:6a; 433 BC). "Some time later" he came again to Jerusalem (13:6b), but the specific time is not designated. Perhaps it was ca. 425 BC (*TTTB*, 125) or even 420 BC (Whitcomb, "Chart of Old Testament Kings and Prophets" on p. 231). This chronology places the writing after 425 BC, perhaps even as late as 400 BC (LaSor, 647). Arguments for later dates based upon stylistic affinities to later Aramaic are unconvincing since the Aramaic of Ezra (of Ezra-Nehemiah) is clearly earlier than that at second century Qumran (LaSor, 648). This dating of approximately 425 BC makes Nehemiah a contemporary of Malachi, which finds support in their common descriptions of post-exilic Judaism.
- B. **Recipients:** Those who first read Nehemiah comprised Jews who had returned from Persia with Ezra three or four decades before, as well as the grandchildren and great-grandchildren of the returnees with Zerubbabel about 125 years earlier.
- C. **Occasion:** This story continues from Ezra about 11 years after Ezra's spiritual reforms among the remnant in Jerusalem. However, whereas Ezra helped the spiritual establishment of the new community, Nehemiah gave it physical, geographical, and political stability (LaSor, 655). Before Nehemiah came on the scene (445 BC) the restored remnant had been back in Judea over 90 years (since 538 BC), the temple had been rebuilt (516 BC), and Ezra's reforms had been instituted (458 BC). However, Nehemiah found the walls and gates still in ruins and took it upon himself to see to it that the city was not left unprotected. Nehemiah's faith in God saw

Him accomplish in 52 days what had not been done in the 93 years since the return under Zerubbabel. Afterwards he wrote this account of how the LORD used him to rebuild the walls in order to encourage the people with God's obvious hand in reestablishing His people in their homeland. This account undoubtedly helped his original readers to see that obedient faith can accomplish God's will despite what appears impossible.

#### IV. Characteristics

- A. Although Esther follows Nehemiah in our English Bibles, Nehemiah actually is later chronologically. Thus it concludes the account of the historical books of the English Bible Old Testament. (Nehemiah's book is followed by Chronicles in the Hebrew OT.)
- B. Perhaps no other book of Scripture provides a better depiction of the balance between dependence and discipline, as well as prayer and planning. His prayers are generally short but fervent (cf. 1:5-11; 2:1-4, 19-20; 4:1-6, 7-10, 11-14; 6:9, 14).
- C. One difficulty in reconciling Nehemiah with Ezra concerns the walls themselves. At the beginning of the account, Nehemiah seems surprised that the walls were broken down. Why would this be news to him in 445 BC since the Babylonians had destroyed them much earlier in 586 BC (2 Kings 25:10)? One clue is perhaps that the walls had begun to be rebuilt under Ezra during the reign of Artaxerxes, but it had been stopped (Ezra 4:12, 21-23). Probably Nehemiah had thought the project was completed (Getz, "Nehemiah," *BKC*, 1:674).
- D. Nehemiah is the only biblical book written mostly in the first person (see Authorship above).

### Argument

The Book of Nehemiah continues the account of Ezra and, as they originally formed a single work, has the same theme: the record of the restoration of God's people in the land which serves to encourage the remnant towards covenant obedience, especially in true temple worship. Ezra indicates how the returns of Zerubbabel and Ezra contributed to the establishment of the new covenant community. Nehemiah completes the restoration with the third and final return under Nehemiah to rebuild the walls (chs. 1–7), followed by the restoration of the people (chs. 8–13). The book also includes some very insightful teaching on leadership principles (chs. 1–7), spiritual principles (chs. 8–10), and moral and social principles (chs. 11–13; cf. *TTTB*, 126).

### Synthesis

#### Restoring the walls and people

<b>1–7</b>	<b>Walls</b>
1–2	Return
1	Persia prayer
2	Jerusalem inspection
<b>3–7</b>	<b>Rebuilding</b>
3	Delegation
4:1–6:14	Opposition
6:15-19	Completion
7	Organization
<b>8–13</b>	<b>People</b>
8–10	Covenant renewed
8	Conviction
9	Confession
10	Covenant
<b>11–13</b>	<b>Covenant obeyed</b>
11:1–12:26	Resettlement
12:27-47	Dedication
13	Final reforms

## Outline

### Summary Statement for the Book

**The restorations of the walls and people in the land under Nehemiah record God's faithfulness to His promise of restoration to encourage the remnant in covenant obedience rooted in temple worship at Jerusalem.**

- I. (Chs. 1—7) **The rebuilding of the walls in the third return under Nehemiah's carefully executed plan despite opposition is given to encourage the remnant in covenant obedience rooted in temple worship at Jerusalem.**
  - A. (Chs. 1—2) God enables Nehemiah to prepare reconstructing the wall in both Persia and Jerusalem by addressing spiritual, economic, planning, enlistment, and defensive procedures so that Jerusalem's repopulation would once again make it a center for worship at the temple.
    1. (1:1—2:8) While in Persia, Nehemiah learns of the broken wall in Jerusalem and intercedes with God and Artaxerxes on behalf of his people, which provides spiritual and economic preparation to reconstruct the wall (fulfills Daniel 9:25 in 444 BC).
    2. (2:9-20) While in Jerusalem, Nehemiah prepares to reconstruct the wall through an inspection of the project, exhortation to the people, and rebuff of his opposers.
  - B. (Chs. 3—7) Nehemiah reconstructs the wall in an amazing 52 days by wisely delegating the project, effectively frustrating the opposition, and protecting the city with guards so that former exiles will feel safe to repopulate Jerusalem.
    1. (Ch. 3) Nehemiah wisely delegates the rebuilding project to workers who construct the portion of the wall nearest to their homes as incentive to do quality work.
    2. (4:1—6:14) Nehemiah effectively handles several means of opposition to the project by appealing to the LORD as well as standing guard against the enemies.
      - a. (Ch. 4) External opposition to the building comes from Sanballat and Tobiah who seek to stop the work through ridicule, threat of attack, and discouragement.
      - b. (Ch. 5) Internal opposition to the building comes from Jews who seize fellow Jews' property and exact a 12% interest rate on debts in contrast to Nehemiah's selfless service as governor.
 

Since the people had only been working on the wall for a few weeks, "the hundredth part of the money, grain, new wine and oil" (5:11) likely refers to usury (interest) *on a monthly basis*, actually yielding an interest rate of 12% annually. Charging any interest to fellow Israelites was a clear violation of the Law (Exod. 22:25; Lev. 25:35-37; Deut. 23:20-21), even though this was rarely observed. For further study, see E. Neufeld, "The Rate of Interest and the Text of Nehemiah 5.11," *Jewish Quarterly Review* 44 (1953/54): 194-204; R. P. Maloney, "Usury and Restrictions on Interest-Taking in the Ancient Near East," *Catholic Biblical Quarterly* 36 (1974): 1-20. Perhaps the actual interest exceeded 12% since commodities were included as well.
      - c. (6:1-14) External opposition to the building again comes from Sanballat, Tobiah, Gershem the Arab, and other enemies who seek to stop the work through compromise, blackmail, treachery, and intimidation by false prophets.
    3. (6:15-19) Despite internal opposition from Tobiah's relatives, Nehemiah finishes the wall in an amazing 52 days which discourages Israel's enemies because they could see that God alone must have enabled the small remnant to complete such a task.

4. (Ch. 7) Nehemiah organizes Jerusalem by posting guards at the gates and using the list of exiles who returned a century earlier to encourage people to feel safe about repopulating the large but almost uninhabited city.

**II. (Chs. 8—13) The restoration of the people through Nehemiah's leading Israel to obey its renewal of the covenant is provided as a stimulus to encourage the remnant in covenant obedience and commitment to the temple.**

- A. (Chs. 8—10) The covenant is renewed and put into writing after the people respond to the Word of God in two days of reading and exposition so as to encourage the remnant in covenant obedience.
  1. (Ch. 8) Conviction: Ezra's reading of the Pentateuch with the Levites' exposition urges the nation to celebrate the Feast of Tabernacles and begins a revival based upon the Word of God.
  2. (Ch. 9) Confession: Everyone gathers again 24 days later to fast, listen to the Law of Moses, worship, confess sin, and renew themselves to obey a written covenant.
  3. (Ch. 10) Covenant: Nehemiah provides a list of those who publicly agree to follow the covenant and its specific stipulations agreed upon as a written record of the people's commitment to obey.
    - a. (10:1-27) A list of the priests, Levites, and leaders of the people who sign the covenant is provided as a reminder of their agreement to obey the Law.
    - b. (10:28-39) Nehemiah records the stipulations of the covenant as submission to the Word, separation by avoiding intermarriage, Sabbath observance, and stewardship responsibilities as a written record of the people's agreement.
- B. (Chs. 11—13) The renewed covenant is obeyed in a resettlement of Jerusalem, dedication of the walls, and various reforms which demonstrate the nation's commitment to the house of the LORD and the covenant stipulations.
  1. (11:1—12:26) The people obey a plan for 10% of the nation to resettle Jerusalem (with leaders, draftees, volunteers, priests, and Levites) so as to protect the city and temple from attack, thus demonstrating their commitment to the house of the LORD.
  2. (12:27-47) The Jerusalem wall is dedicated with participation by Levites, two choirs, and men who collect contributions for the temple service, again demonstrating their commitment to the house of the LORD.
  3. (Ch. 13) Nehemiah's final reforms (432 BC) forbid the temple from foreigners, supply support for temple workers who had returned to farming, correct Sabbath abuses, and prohibit future mixed marriages to force Israel to obey the covenant stipulations.

## Focusing Your Narrative Idea on Authorial Intent

### An Example from Nehemiah 1–2

#### A Different Approach

Nearly all evangelical commentaries expound the Book of Nehemiah as if it's a manual on effective leadership (see Edwin M. Yamauchi, "Ezra-Nehemiah," *EBC*, 4:591; Donald K. Campbell, *Nehemiah: Man in Charge*, 23; Charles R. Swindoll, *Hand Me Another Brick: A Study in Nehemiah*; Gene A. Getz, "Nehemiah," *BKC*, 1:673-74). I think this emphasis has problems:

1. It is highly questionable that the authorial intent of the Book of Nehemiah is to train readers as better leaders. I feel that it is unlikely that the first readers saw the primary purpose of the book as holding up the man Nehemiah as a model to follow.
2. This perspective places undue attention to the human instrument, Nehemiah himself, rather than on the God who sovereignly led him to the accomplish the task (1:5, 9-11; 2:4b, 8b, 12, 18, 20).
3. It puts the stress on *how* the walls of Jerusalem were raised which is but a minor focus. The real emphasis should be *why* the walls needed to be rebuilt (2:17).
4. Ezra and Nehemiah in the Hebrew Bible constitute one book and therefore should share a common theme. Since Ezra is not a manual on leadership then this should not be expected of Nehemiah as well.
5. This view also limits proper application only to those in leadership positions.
6. The leadership view hardly takes into account the historical background and chronology. A careful evaluation of the historical situation and how the book fits into the total plan of God brings the Lord to center-stage as the sovereign, covenant-keeping God (see below).

#### Exegetical Outline

##### Prologue

*Historical background:* About 1500 years earlier God had promised Abraham that He would make his descendants into a great nation possessing the entire land from the River of Egypt to the Euphrates (Gen. 12:1-3; 15:18f.). Hundreds of years later God further spoke through Isaiah and many other prophets that a Davidic king called the Messiah would rule Israel in this geographical domain. However, the nation rebelled against the Lord and went into exile as the Law had warned (Deut. 28). The key question looming in the minds of the exiled Jews was whether God would still fulfill His promise of a new nation in Palestine under the Messiah as ruler. Was He still sovereign even though His people were in such distress?

*Historical foreground:* No doubt people wondered how a Messiah could be offered to the nation if Israel was still in exile. For example, one of the messianic prophecies stated that He would be born in Bethlehem (cf. Micah 5:2, written nearly 200 years earlier). Surely the nation would have to sometime return to its homeland for the Messiah to offer the kingdom—an offer which indeed did occur under Christ (Matt. 10:7) but was rejected. Furthermore, Daniel had recorded only a few years earlier that Artaxerxes' command to rebuild Jerusalem under Nehemiah (444 BC) would begin "seventy sevens" (490 years) of prophetic years in the nation's history (Dan. 9:25). The 69th prophetic year (483rd year) would culminate in the death of Messiah in AD 33 (Dan. 9:26).

The postexilic era testifies to the gracious hand of a sovereign God who had not forgotten His promises, for under Zerubbabel and Ezra a small remnant had returned from Babylon, rebuilt the temple and begun reforms. The building under Nehemiah completes this record with a direct fulfillment of Daniel 9:25. Thus, the account of Ezra-Nehemiah shows that God is indeed the God over all gods (Ezra 1:2), a covenant-keeping God. Likewise, His people need to keep the covenant as well (Yamauchi, *EBC*, 4:590).

**Exegetical Idea:** The means by which God sovereignly fulfills His promise to preserve Israel in a restored Jerusalem was through preparing Nehemiah to rebuild the city wall.

- I. (Ch. 1) The means by which the sovereign God (“God of heaven,” vv. 4, 5) prepared to restore the covenant city of Jerusalem was through placing upon Nehemiah both the burden and position to be used of God.
  - A. (1:1-3) God informed Nehemiah that the covenantal people and city were in shame.
  - B. (1:4-11a) God moved Nehemiah to recognize both Israel’s sin and His promises and ability to restore the nation.
  - C. (1:11b) God had placed Nehemiah in a prominent position to restore Jerusalem to the stature befitting Jerusalem as the city inhabited by the sovereign Lord.
- II. (2:1-8) The means by which the sovereign God prepared to restore Jerusalem was through granting Nehemiah’s requests before King Artaxerxes.
- III. (2:9-20) The means by which the sovereign God prepared to restore Jerusalem was through granting Nehemiah honor among the people after his inspection of the walls despite opposition from those outside of the covenant community.
  - A. (2:9-10) God granted Nehemiah honor before the Persian officials over the opposition.
  - B. (2:11-16) God granted Nehemiah honor before the people by being informed of the task.
  - C. (2:17-20) God granted Nehemiah honor before the people by reminding them that God was surely in their work despite opposition.

**Homiletical Exposition** (cyclical inductive form) Title: “Where God guides, God Provides”

**Introduction:**

1. Sometimes it seems like things happen without any divine purpose to it all (examples).
  2. How we can know that God wills for us to accomplish a certain task (subject)?
  3. When Israel was taken away from her land things looked hopeless— could the nation once again be completely restored? The Book of Ezra records a partial restoration, but the city walls were still destroyed. Was God still with *them* and still the sovereign Lord? And how can *we* be reminded that God is really sovereign (subject restated)?
- I. God sovereignly *provides both the vision and ability* to do certain ministries.
    - A. God gave Nehemiah both the burden and position to be used in rebuilding the wall (ch. 1).
    - B. God gives us vision and strategic positions to serve Him when we are obedient.
  - II. God sovereignly *prepares other key people* as resources to help His people do His tasks.
    - A. God granted Nehemiah’s requests before King Artaxerxes (2:1-8).
    - B. God prepares the hearts of others to enable us to do His will too.
  - III. God sovereignly *helps His people gain the respect needed* to accomplish His tasks.
    - A. God gave Nehemiah honor among the people despite opposition after he inspected the walls (2:9-20).
    - B. God gives us the credibility needed to do His will.

**Main Idea:** God sovereignly gives us the needed vision, resources, and credibility to do His tasks.

**Restatements:** Where God guides, God provides! He always equips us to accomplish His will.

**Application:** What vision, place of influence, resources, and credibility has He given *you*?

# Jerusalem of the Returning Exiles

*The Bible Visual Resource Book, 99; Gene Getz, "Nehemiah," in Bible Knowledge Commentary, 1:679*

## Jerusalem of the Returning Exiles

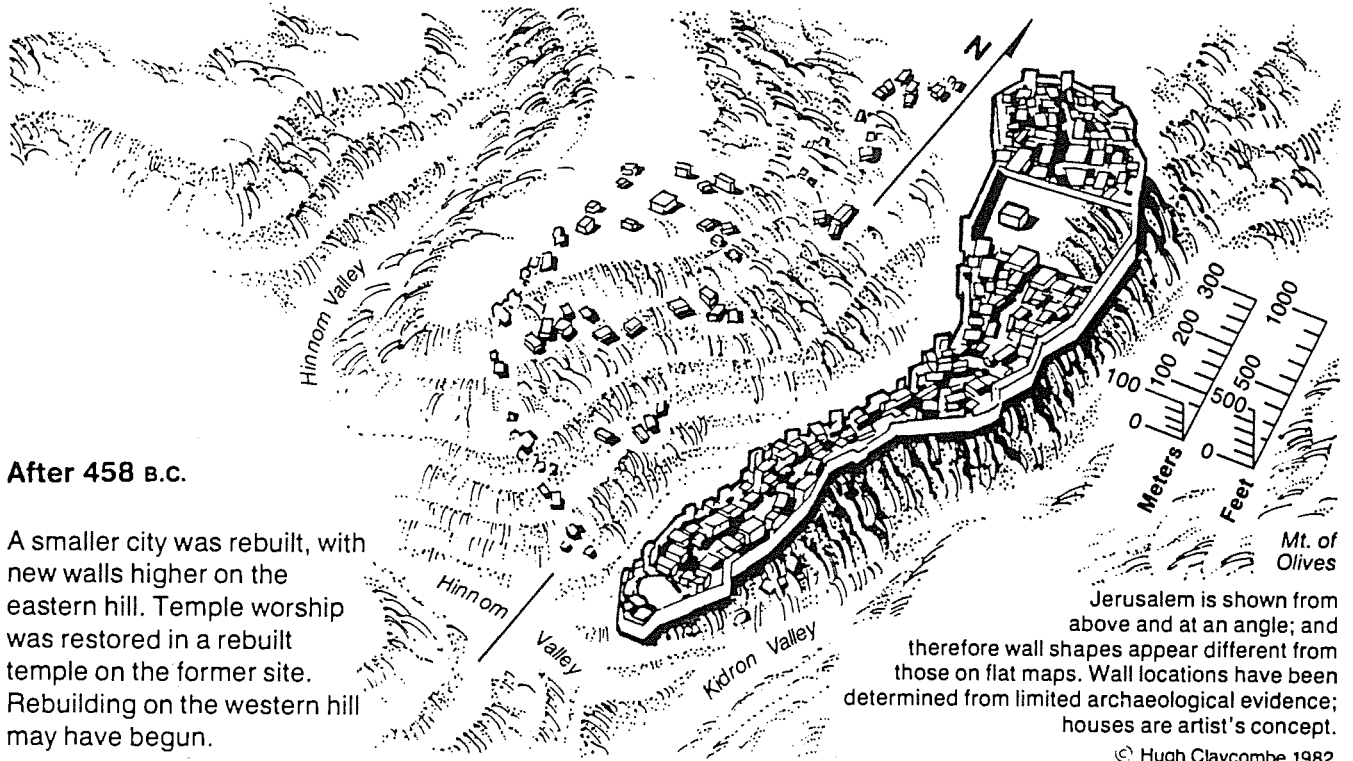

### After 458 B.C.

A smaller city was rebuilt, with new walls higher on the eastern hill. Temple worship was restored in a rebuilt temple on the former site. Rebuilding on the western hill may have begun.

Jerusalem is shown from above and at an angle; and therefore wall shapes appear different from those on flat maps. Wall locations have been determined from limited archaeological evidence; houses are artist's concept.  
© Hugh Claycombe 1982

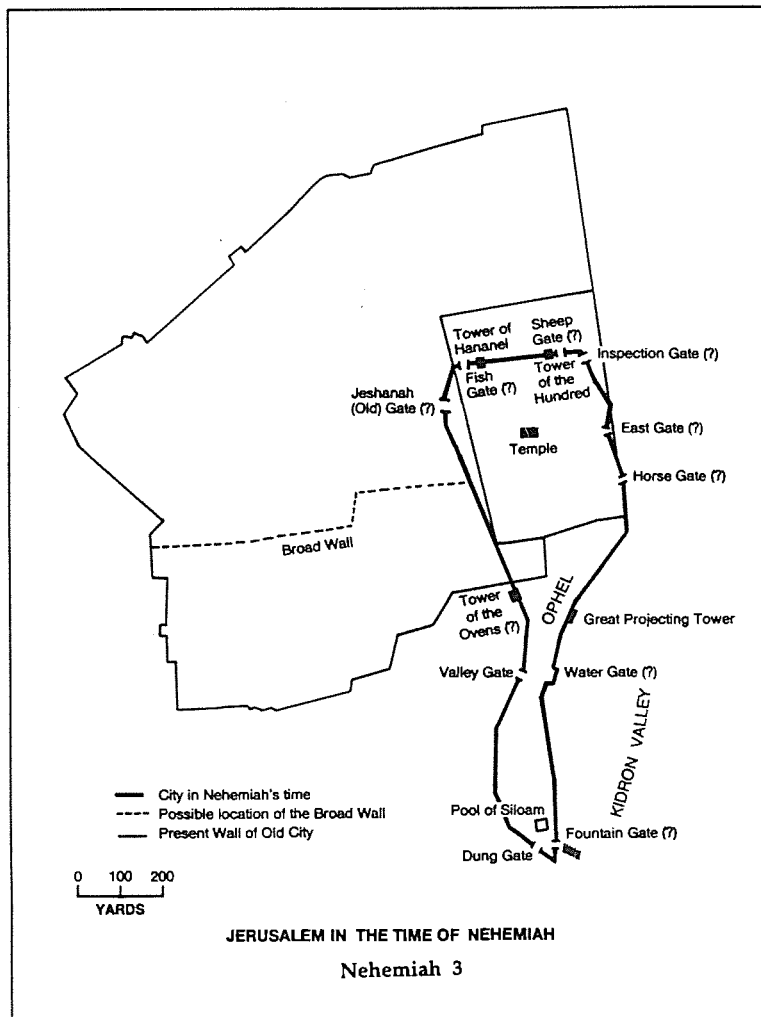

## Nehemiah's Responses to Problems

Gene Getz, "Nehemiah," in *Bible Knowledge Commentary*, 1:681

### Nehemiah's Problems and His Responses

#### Problems

1. Walls broken and gates burned (1:2-3)
2. False accusation of the workers (2:19)
3. Ridicule of the workers (4:1-3)
4. Plot to attack the workers (4:7-8)
5. Physical exhaustion and threat of murder (4:10-12)
6. Economic crisis and greed (5:1-5)
7. Plot to assassinate (or at least harm) Nehemiah (6:1-2)
8. Slander against Nehemiah (6:5-7)
9. Plot to discredit Nehemiah (6:13)
10. Tobiah moved into a temple storeroom (13:4-7)
11. Neglect of temple tithes and offerings (13:10)
12. Violation of the Sabbath by business activities (13:15-16)
13. Mixed marriages (13:23-24)

#### Responses

1. Grief and *prayer* (1:4), and motivation of the people to rebuild (2:17-18)
2. Confidence that God would give them success (2:20)
3. *Prayer* (4:4-5) and action (greater diligence in the work, 4:6)
4. *Prayer* and action (posting of a guard, 4:9)
5. Positioning of people by families with weapons (4:13, 16-18) and encouragement of the people (4:14, 20)
6. Anger (5:6), reflection, rebuke (5:7), and action (having the people return the debtors' interest, 5:7b-11)
7. Refusal to cooperate (6:3)
8. Denial (6:8) and *prayer* (6:9)
9. Refusal to cooperate (6:11-13) and *prayer* (6:14)
10. Tossing out Tobiah's furniture (13:8)
11. Rebuke (13:11a), stationing the Levites at their posts (13:11b), and *prayer* (13:14)
12. Rebuke (13:17-18), posting of guards (13:19), and *prayer* (13:22)
13. Rebuke (13:25-27), removal of a guilty priest (13:28), and *prayer* (13:29)



## **Nehemiah's Leadership**

Donald K. Campbell, *Nehemiah: Man in Charge*, 23

While leadership is not the main purpose of the book, nevertheless, the man Nehemiah exemplifies many principles for good leadership. Some these include the following:

1. He established a reasonable and attainable goal.
2. He had a sense of mission.
3. He was willing to get involved.
4. He rearranged his priorities in order to accomplish his goal.
5. He patiently waited for God's timing.
6. He showed respect to his superior.
7. He prayed at crucial times.
8. He made his request with fact and graciousness.
9. He was well prepared and thought of his needs in advance.
10. He went through proper channels.
11. He took time (three days) to rest, pray, and plan.
12. He investigated the situation firsthand.
13. He informed others only after he knew the size of the problem.
14. He identified himself as one with the people.
15. He set before them a reasonable and attainable goal.
16. He assured them God was in the project.
17. He displayed self-confidence in facing obstacles.
18. He displayed God's confidence in facing obstacles.
19. He did not argue with opponents.
20. He was not discouraged by opposition.
21. He courageously used the authority of his position.

# Chronicles

RUSSALEM, 26 TISHRI, 3317  
(B.C.E.)

NEWS OF THE PAST

VOL. I, NO. 26

## Success Crowns Work of Ezra and Nehemiah

# NATION PLEDGES ALLEGIANCE TO TORAH; FIRST KNESSET OPENS IN JERUSALEM

### REPOPULATION OF JERUSALEM BY DECREE

*(Chronicles News Service)*

As out of every ten families now residing outside Jerusalem will be called to leave its current site of abode and come to the capital.

Decree to this effect was issued by the Governor's Office, which announced that lots be cast to determine the step was taken, it explained, in order to one of Judah's most serious problems; the removal of the capital, that it has been made from a military point of view.

Times are to be built on city's western hill as under the programme, it is the fact that this on has not yet been surpassed by a wall.

### DEDICATION OF CITY WALL - TOMORROW

*(Chronicles News Service)*

The dedication of Jerusalem's new wall will take place tomorrow, according to an official announcement from the Governor's Office. The construction of the edifice was completed a month ago, but the dedication ceremony was postponed to allow the Torah Covenant to take precedence.

The work on the wall was performed in the amazingly short time of 52 days, the men toiling practically without a let-up, under the able supervision of their energetic leader, Governor Nehemiah.

In some places the old wall had been completely destroyed, and it was necessary first to remove the debris — an operation that entailed more work than the actual building. But the men were fully aware of the urgency of the work they were doing, and they

### NEHEMIAH PAYS GLOWING TRIBUTE TO EZRA

*(Chronicles News Service)*

Governor Nehemiah this morning paid glowing tribute to Ezra the Scribe for the work he had done in preparing the people for this great day.

The Governor's remarks were made in a speech before the assembled masses, in which he praised the 120 Assemblymen to represent the people of Judah, to legislate for them, and to sign laws and treaties on their behalf. This, said Governor Nehemiah, he did by dint of the authority vested in him by King Artaxerxes of Persia.

Nehemiah stressed the gravity of the hour and warmly praised Ezra, who paved the way for today's achievement through the tremendous job he had performed over a period of many years, in raising a generation of scribes and teachers to lift the people from the low spiritual level to which they had fallen during the exile years.

"Not Since Moses..." "Not since the days of Moses ben Amram," the

### Intermarriage Banned; Work on Sabbath Outlawed; Temple Offerings Re-Instituted

*By a Staff Writer*

The nation's leaders — 120 in number — today solemnly placed their signatures on a document, formulated by Ezra the Scribe, which obliges the people of Judah to regulate their lives according to the Torah — the Law of Moses.



GREAT MOMENT: Judah's leaders sign Covenant

The main points of the Covenant are the following: (1) Prohibition of mixed marriages; (2) Observance of the Sabbath — binding on all citizens of Judah, including Gentiles; (3) Re-institution of the Sabbatical Year, effecting land and monetary debts; (4) Re-institution of Temple tithes and offerings.

The historic signing ceremony brought to an end a series of great events that commenced on the first day of the month, when Ezra began reading the Torah word for word to the assembled masses.

### Crowds Cheer Nehemiah For '52-Day Wonder'

*By a Staff Writer*

AT long last, the nation's leaders are beginning to see the fruits of their labour. Thanks to Governor Nehemiah's untiring efforts, the enemy's attacks on Jerusalem have

dwindled to the vanishing point. The capital's brand-new wall, erected in record time (it's being called "Nehemiah's 52-Day Wonder"), has imbued us with fresh confidence as we face the future.

As for Ezra, it must have given him a good deal of satisfaction to watch those crowds at the Water Gate earlier this month, eagerly drinking in his words — the words of the Torah — and coming back day after day, for more. Only Ezra had to wait a little longer for his triumph: His work began 13 years ago.

Of the two, Nehemiah is the more popular figure. But that was to be expected. His was the more spectacular achievement by far.

Nehemiah's address was interrupted repeatedly by great bursts of applause and cheering. A relatively small portion of the crowd was able to catch the words of the speakers, but the gist of what was said was passed along to those who were out of ear-shot, by men who had been posted at "strategic spots" among the multitude.

When the Governor had finished speaking, he took his place, and the signing ceremony got under way.

### COMPOSITION OF FIRST KNESSET

The signatories to the Torah Compact — who also constitute the membership of the new Knesset — may be classified into groups as follows:

Priests	27
Levites	13
Family Heads	64
Writers and Prophets	35

If we add to this list the names of Gov. Nehemiah and the Scribe, we come up with a total membership of 120.

### Governor Calls For Annulment of Debts

*By a Staff Writer*

A few hours after the Covenant ceremony, Governor Nehemiah convened the officials and big landowners of Judah and called upon them to join with him in announcing the immediate cancellation of all outstanding debts.

The economic situation of most of Judah's farmers is extremely grave this year, the Governor explained, because of the drought and the hostile activities of the Edomites and other neighbouring tribes.

In addition, many farmers were had conscripted in recent months, along with artisans, tradesmen, and men from other walks of life, to help build Jerusalem's new wall, and this has aggravated their situation, causing hardship and suffering to their families.

### Chanani to Head Defence Set-Up

*(Chronicles News Service)*

Chanani, brother of Governor Nehemiah, has been placed in charge of all matters relating to the defence of Jerusalem.

Chanani is a veteran resident of Jerusalem, having come here with Ezra 13 years ago. It was he whom Ezra despatched to Persia in order to inform Nehemiah, then living in Shushan, of the gravity of Jerusalem's position.

His assistant will be Chananiah.

### Nehemiah Again Puts Off 'Big 4' Meeting at Ono

*Special to CHRONICLES*

CHEN, 25 Tishri.—From Samaritan sources it is said that Governor Nehemiah of Judah has again put down the invitation of Sanballat, head of the lot of Samaria, to come to the village of Ono, on the Juda-Samaria border, for a conference of the "Big 4" of the area: Gashmu, leader of the Edomites, Ah, leader of the Ammonites, Sanballat, and Mishah.

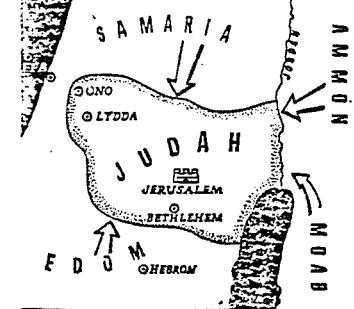

Med in on all sides, Judah fights for her existence

Sanballat issued an announcement today in which he sharply criticized Nehemiah for his repeated refusal to appear at such a meeting — the purpose of which, according to Sanballat, is "simply to adjust relations among these nations; and to bring about peace in the area."

**Fourth Call**

Sanballat's leader said that this is the time that Nehemiah asked for a postponement of the conference on grounds that he is busy; despite the fact that the place designated for the site of the meeting is no more than four one-half hours' ride from Jerusalem.

Sanballat is charging that the Athenian leader, General Pericles, has been strengthening his naval forces with a view to resuming the war and extending the rule

### '30-Year Peace' in Jeopardy As Athens-Sparta Rift Widens

*By Our Correspondent*

**ATHENS.**—Only one year has passed since the signing of the "Thirty Years' Peace" between the Delian League headed by Athens and the Peloponnesian League headed by Sparta. Yet already there is growing tension in the relations between the two sides, and it is feared that hostilities may be renewed long before the term of the peace pact has expired.

Sparta is carrying on an intensive campaign of incitement against Athens, charging that the Athenian leader, General Pericles, has been strengthening his naval forces with a view to resuming the war and extending the rule

General went so far as to make the following statement: "In time of war, retreats and temporary losses of territory may be necessary in order to enable us to concentrate our forces on the home front — Athens herself — and on the sea. It is imperative that Athens maintain her naval supremacy over her enemies."

And so, with the sabre-rattling on both sides becoming louder and louder, people everywhere are beginning to ask: How long will the "Thirty Years' Peace" really last?

### Capital's Gates to Close on Sabbath

In keeping with the signing of the Torah Covenant and the acceptance by the people of the Law of Moses as binding on the nation as a whole, Governor Nehemiah today issued instructions to close all the city's gates at sundown on Friday and to post sentries at the gates to prevent merchants and traders from entering Jerusalem and transacting business on the Sabbath day.

### Capital's Gates to Close on Sabbath

It will be recalled that Nehemiah lashed out recently at the Jewish landowners who insist on sending their produce into Jerusalem on this day of rest, using the hired services of non-Jews to perform this forbidden work for them.

From now on the Sabbath law will apply to the entire nation — Jews and non-Jews alike. (See *Timely Topics*, on Page 3)

# Esther

<b>Extermination Plot Foiled</b>				
<b>Plot Planned</b>		<b>Plot Foiled</b>		
Chapters 1–4		Chapters 5–10		
Threat		Triumph		
Providence Prepared		Providence Enacted		
Persecution		Preservation		
Grave Danger		Great Deliverance		
Feasts of Ahasuerus		Feasts of Esther and Purim		
Esther Exalted 1:1–2:18	Haman Plots 2:19–4:17	Mordecai over Haman 5:1–8:2	Jews over Enemies 8:3–9:32	Mordecai over Persia 10
Persia				
10 Years (483-473 BC)				

**Key Word:** Providence

**Key Verse:** (Mordecai to Esther) “For if you remain silent at this time, relief and deliverance for the Jews will arise from another place, but you and your father’s family will perish. And who knows but that you have come to royal position for such a time as this?” (Esther 4:14).

**Summary Statement:**

An extermination of the Jewish nation plotted by Haman reverts upon his own head through God's providence through Mordecai and Esther to encourage postexilic Israel of God's continued commitment to the Abrahamic Covenant.

**Application:**

Use your providentially placed position to help God’s people.

# Esther

## Introduction

**I. Title** Esther (אֶסְתֵּר *'ester*) is a Persian name derived from the Persian word for "star" (*stara*; BDB 64d). The meaning is fitting since Esther is the star of this book which bears her name. Her Hebrew name, Hadassah, means "myrtle(-tree)" (הַדַּסָּה BDB 213c; cf. 2:7).

## II. Authorship

- A. External Evidence: The Jewish discussions regarding Esther have concerned several other issues more than authorship, which remains anonymous (see "Characteristics" section). Therefore, parallel passages and opinions of the Church and Synagogue concerning authorship have not been significant.
- B. Internal Evidence: Since the book gives no hint who wrote it one can only guess his identity. The account shows such detail of Persian and Jewish life that it is difficult to suppose an author who was not Jewish and well acquainted with Persian ways. Some suggest Ezra or Nehemiah as author, but the vocabulary and style of Esther does not match either of these two books. Others maintain that Mordecai penned the work, but chapter 10 implies that his career had already ended (*TTTB*, 131), unless, of course, this chapter was added later. Therefore, no one really knows who wrote the book.

## III. Circumstances

- A. Date: While critical scholars have claimed that Esther was written much later than the time of its contents (because of its language and style), their arguments are unconvincing. Since the events of the book close at 473 BC it is reasonable to presume a date shortly after this—perhaps after Xerxes' reign (ending in 464 BC) but no later than 435 BC when the palace at Susa was destroyed by fire, a significant event not mentioned in Esther.
- B. Recipients: Esther's first readers constituted the postexilic communities during the time of Nehemiah and Malachi and the intertestamental period—probably initially in Persia but soon in Israel as the book was copied and distributed. These providential dealings of God on their behalf would have been a tremendous source of encouragement to both Jews in Persia as well as Jews living in Israel.
- C. Occasion: The events of Esther chronicle 10 years of the 58 year gap between Ezra 6 (516 BC) and Ezra 7 (458 BC). The story takes place from 483 to 473 BC between the time of the first return under Zerubbabel (538 BC) and the second under Ezra (458 BC). Without Esther the Scripture would remain silent as to the state of the majority of post-exilic Jews who chose to remain in Babylon when a small remnant of their brothers returned to the land. Why did they remain? They were prospering materially and therefore saw nothing but hard work by returning to Jerusalem, a city that lacked even walls (cf. Book of Nehemiah). The Books of Ezra and Nehemiah assert God's providential care over the small remnant that returned, while Esther reveals that God even graciously cared for these spiritually indifferent Jews whose priorities needed rearranging.

## IV. Characteristics

- A. Historicity: Esther contains much in the way of eyewitness accounts about the Persian Empire, of which little has been verified from outside sources. Only recently has Ahasuerus been identified with Xerxes who reigned over Persia from 485-465 BC.
- B. Canonicity: The usefulness of Esther has long been debated. Maimonides taught that when the Messiah comes, every book of the Jewish Scriptures would pass away but the Law and Esther, which would remain forever. On the other hand, Martin Luther said he wished the book had never been written because of the many problems it poses (Donald K. Campbell, "Esther," DTS Class Notes, 1984, 1).

The reasons for differing opinions on the book stem from many unique characteristics:

1. The name of God is never mentioned in the book (although His hand is very evident).
  2. Esther is never quoted in the New Testament nor found among the Dead Sea Scrolls.
  3. It never mentions the Law or Jewish sacrifices or offerings.
  4. It never refers to prayer (although fasting is mentioned).
  5. The book contains no mention at all of anything spiritual.
  6. Its unique literary type (i.e., almost a drama) has caused it to be placed within several different sections in various collections of Old Testament books.
- C. Placement: Esther is the only biblical book with a history of the Jews outside of the land during the times of the Gentiles (586 BC until the return of Christ). This may explain why it appears as the last historical book in English Bibles, for while it precedes Nehemiah chronologically, the same conditions in the book continue during the time of the Gentiles until the deliverance of the Jews at the return of Christ (Campbell, 2).
- D. Lessons: The Book of Esther teaches several principles such as (Campbell, 2):
1. Satan's purpose is to destroy the Jews by use of the nations.
  2. God's purpose is to preserve the Jews by use of the nations.
  3. God works in the affairs of nations to accomplish His will to preserve His people.
  4. God works in the affairs of individuals to accomplish His will to preserve His people.
- E. Interpretation: At least four different hermeneutical methods have been employed in seeking to understand the message of Esther:
1. **Prophetical**—Esther predicts that the Jews will be preserved while outside of the land during the times of the Gentiles.  
  
Response: Nothing is mentioned of the “times of the Gentiles” and the account is presented in a straightforward manner as history.
  2. **Allegorical**—Esther is the story of mankind.  
  
Response: This is ambiguous and the account is presented in a straightforward manner as historical narrative.
  3. **Typical**—Esther is a divinely intended illustration of the Christian experience in the Church Age or a type of the Millennium. "Some suggest a typical application as follows. The replacing of Vashti (a Gentile) by Esther (a Jew) typifies the setting aside of Christendom and the taking up of Israel. Haaman, the enemy of the Jews, typifies the anti-Christ to be destroyed at the second coming. The numerical value of the Hebrew letters of Haaman the wicked is 666. Mordecai is a type of Jesus Christ in His glorious exaltation. The triumph of the Jews is typical of the millennium" (Campbell, 2).  
  
Response: While this is an ingenious view, it fails in that it reads the NT back into the OT (which means that its original readers would not have understood the meaning). Also, the spelling of “Haman” must be altered to fit this numerical scenario!
  4. **Historical**—Esther records God's providential care of His chosen people as evidence of His commitment to the Abrahamic Covenant. The following "Argument" section will demonstrate this to be the best option.

## Argument

Esther records a historical story of how a plot to exterminate the entire Jewish population is averted by God's providential workings through the godly Jewess, Queen Esther. The account cites the threat to the Jews (chs. 1—4) and the triumph of the Jews over the very ones who threatened their existence (chs. 5—10). The latter part of chapter 9 celebrates the preservation of the nation in the Feast of Purim, which serves as an annual reminder of God's faithfulness on behalf of His people.

## Synthesis

### Extermination plot foiled

<b>1 – 4</b>	<b>Plot planned—threat</b>
1:1—2:18	Esther exalted
1	Vashti divorced
2:1-18	Esther married
2:19—4:17	Haman plots
2:19-23	Mordecai: plot to murder the king
3	Haman: plot to murder the Jews
4	Esther challenged
<b>5 – 10</b>	<b>Plot foiled—triumph</b>
5:1—8:2	Mordecai over Haman
5:1-8	Invitation offered
5:9-14	Gallows built
6	Mordecai honored
7	Haman hanged
8:1-2	Mordecai promoted
8:3—9:32	Israel over enemies
8:3—9:16	Counter-decree slaughter
9:17-32	Purim
10	Mordecai over Persia

## Outline

### Summary Statement for the Book

**An extermination of the Jewish nation plotted by Haman reverts upon his own head through God's providence through Mordecai and Esther to encourage postexilic Israel of God's continued commitment to the Abrahamic Covenant.**

- I. (Chs. 1—4) Haman's plot to exterminate the Jewish people becomes known to Mordecai and Esther, whom God has strategically placed, to inform Israel that apart from God's intervention it could not exist as a nation.
  - A. (1:1—2:18) Esther is selected as queen to replace the deposed Vashti as God's intervention to save His people from annihilation as a nation.
    1. (Ch. 1) Xerxes (called Ahasuerus in the Hebrew text throughout the book) divorces his disobedient Queen Vashti, not knowing that God was preparing the way for Esther to replace Vashti for the preservation of the Jews (483 BC; 1:3).
    2. (2:1-18) Xerxes marries Esther to replace Vashti after a four-year-long beauty contest under the divinely designed favor of Hegai, showing God's control also over Xerxes' taste in women as His intervention for a disaster soon to face Jews (479 BC; 2:16).
  - B. (2:19—4:17) Haman plots to kill the Jews just after Mordecai reveals the plot to murder the king, both events being God's design to ultimately protect His people through Esther in faithfulness to the Abrahamic Covenant.
    1. (2:19-23) God informs Mordecai of secret information which saves Xerxes' life through uncovering an assassination plot as the LORD's design to later exalt Mordecai to benefit His people.
    2. (Ch. 3) Haman, angered at Mordecai's refusal to pay him honor, convinces Xerxes to proclaim the killing of all Jews from Egypt to India (cf. 1:1; 3:6) on one day in eleven months as God's preparation for the opposite to occur—the protection of His people.

3. (Ch. 4) Mordecai convinces Esther to risk her life to save the Jews by indicating that God had placed her as queen for this purpose but that even if she fails to do it then He will deliver His people by another means in faithfulness to the Abrahamic Covenant.

## **II. (Chs. 5—10) Haman's extermination plot reverts upon his own head through God's providential workings in Mordecai and Esther to encourage postexilic Israel of God's continued commitment to the Abrahamic Covenant.**

- A. (5:1—8:2) Mordecai triumphs over Haman as evidence of God's faithfulness to those who fear Him.
  1. (5:1-8) Esther's boldness before the king is enthusiastically and curiously accepted, but Esther only invites him to a banquet to put him in the proper mood to grant her request.
  2. (5:9-14) Haman arrogantly plots to murder Mordecai on a 75 foot gallows as God's provision for his own death to protect the Jews.
  3. (Ch. 6) Mordecai is honored by, of all people, Haman himself, who returns home humiliated.
  4. (Ch. 7) Haman dies on the gallows prepared for Mordecai as evidence that God protects those who fear him and punishes those who oppose Him and His people.
  5. (8:1-2) Mordecai is elevated to Haman's position and appointed over Haman's estate to demonstrate that those who plot evil will only prepare the way for the righteous to prosper.
- B. (8:3—9:32) Israel triumphs over its enemies and begins to celebrate this annually in the Feast of Purim as evidence of God's faithfulness to the Abrahamic Covenant.
  1. (8:3—9:16) The Jews are delivered in a massive slaughter of their enemies authorized by a counter-decree for their self-defense as evidence of God's faithfulness to the Abrahamic Covenant.
    - a. (8:3-17) Xerxes commands Esther and Mordecai to write a counter-decree which allows the Jews to defend themselves against their enemies, and this turn of events by God causes many Gentiles to become proselytes.
    - b. (9:1-16) The Jews slaughter at least 75,810 enemies in two days of vengeance with the help of the royal officials as evidence of God's faithfulness to the Abrahamic Covenant by not allowing His people to be annihilated (February-March 473 BC).
  2. (9:17-32) Mordecai and Esther authorize an annual celebration of the Jews' victory over their enemies in the Feast of Purim (plural for *pur*, lot, which was thrown by Haman) so that Israel might not forget God's gracious workings on its behalf (cf. p. 133).
- C. (Ch. 10) The LORD exalts Mordecai to second in command next to Xerxes because of his selfless concern for the Jews, which demonstrates God's blessing upon those who seek the welfare of others more than personal concerns.

## Chronology of the Persian Period

John H. Walton, *Chronological and Background Charts of the OT*, 2d ed., 70

PERSIAN KING	DATES	BIBLICAL CORRELATION	GREEK CORRELATION
CYRUS	539-530	Return of Zerubbabel and Jeshua (Ezra 1-3)	
CAMBYSES	530-522	Rebuilding at Jerusalem stopped (Ezra 4)	
DARIUS I	522-486	Haggai and Zechariah prophesy (520) Temple completed (516) (Ezra 5-6)	Greeks defeat Persians at Marathon (490)
XERXES	486-464	Story of Esther (Esther 1-9)	Greeks defeat Persians at Thermoplae (480 and Salamis (479) Herodotus 485-425
ARTAXERXES I	464-423	Return of Ezra (458) (Ezra 7-10) Return of Nehemiah (445) (Nehemiah 1-2) Prophecy of Malachi (433)	Golden Age (461-431) Pericles (460-429) Athens rules
DARIUS II	423-404	B I B L I C A L  S I L E N C E	Peloponnesian Wars (431-404) Athens falls (404) Sparta rules
ARTAXERXES II	404-359		Socrates (470-399) Plato (428-348) Aristotle (384-322)
ARTAXERXES III	359-338		Philip II of Macedon defeats Greeks at Chaeronea in 338
ARSES	338-335		
DARIUS III	335-331		Alexander the Great overthrows Persian Empire
ALEXANDER	336-323		Establishment of Greek Empire



## Key Dates Related to the Book of Esther

REFERENCE	DATE	EVENT
—	486	<i>Xerxes' reign began</i>
1:3	483 (3rd year of Xerxes)	<i>Xerxes threw a 7-day banquet for his nobles and officials in which Queen Vashti was deposed</i>
—	482-479	<i>Xerxes led disastrous campaigns against Greece as recorded by the Greek historian Herodotus (7.8)</i>
2:16	December 479 or January 478	<i>Esther became queen after a four-year beauty contest</i>
3:7	Early April 474	<i>During the fifth year of Esther's reign, Haman and the astrologers (5:10, 14; 6:12-13) cast the pur (lot) to determine the day of the planned extermination of the Jews eleven months later (7 March 473)</i>
3:12	April 17, 474  (13th of Nisan)	<i>Xerxes' first edict (to destroy the Jews) informed everyone of the fateful day, royal secretaries wrote it out in the various languages of the empire</i>
8:9	June 25, 474  (23rd of Sivan)	<i>Xerxes' second edict (to protect the Jews) was sent out two months and ten days after the first one on April 17</i>
3:13 8:12 9:1, 17a	March 7, 473  (13th of Adar)	<i>Rather than being destroyed on this day, Jews protected themselves by killing at least 75,810 enemies eight months and twenty days after the counter-edict was signed</i>
9:17b-18a	March 8, 473  (14th of Adar)	<i>Jews feasted in celebration of their victory throughout the empire except in Susa where they killed their enemies an additional day (today Jews everywhere except Jerusalem celebrate Purim on this day, the 14th of Adar)</i>
9:18b	March 9, 473  (15th of Adar)	<i>Jews feasted in celebration of their victory in Susa (today Jews in Jerusalem celebrate Purim on this day, the 15th of Adar)</i>
—	464	<i>Palace at Susa destroyed by fire and Xerxes reign ended</i>

## Banquets in the Book of Esther

One key theme in Esther is feasting. There are ten banquets in the book, spread fairly evenly so that nearly every chapter has a banquet:

	<i>References</i>	<i>Hosts</i>	<i>Guests</i>	<i>Events</i>
<b>1</b>	<b>1:3-4</b>	<b>Xerxes</b>	<b>Nobles and Officials</b>	<b>Wealth of the kingdom displayed over 180 days</b>
<b>2</b>	<b>1:5-8</b>	<b>Xerxes</b>	<b>All the people</b>	<b>Wine flowed for everyone for 7 days</b>
<b>3</b>	<b>1:9</b>	<b>Vashti</b>	<b>Palace women</b>	<b>Vashti deposed for declining to attend Xerxes' banquet</b>
<b>4</b>	<b>2:18</b>	<b>Xerxes</b>	<b>Nobles and Officials</b>	<b>Esther introduced as the new queen</b>
<b>5</b>	<b>3:15</b>	<b>Xerxes</b>	<b>Haman</b>	<b>Annihilation of the Jews decreed by the king</b>
<b>6</b>	<b>5:1-8</b>	<b>Esther</b>	<b>Xerxes and Haman</b>	<b>Xerxes kept in suspense as to Esther's request</b>
<b>7</b>	<b>7:1-10</b>	<b>Esther</b>	<b>Xerxes and Haman</b>	<b>Esther exposes Haman as seeking her life</b>
<b>8</b>	<b>8:17</b>	<b>Jews</b>	<b>Jews</b>	<b>Rejoicing over the king's edict on the Jews behalf and many Gentiles became Jews</b>
<b>9</b>	<b>9:17</b>	<b>Jews</b>	<b>Jews</b>	<b>Rejoicing over slaughter of 75,810 or more enemies of the Jews</b>
<b>10</b>	<b>9:18-32</b>	<b>Jews</b>	<b>Jews</b>	<b>Feast of Purim established to be an annual event through Mordecai's decree</b>



# Map of Esther's Canonical Status

Carey A. Moore, *Esther*, Anchor Bible, xxvi-xxvii

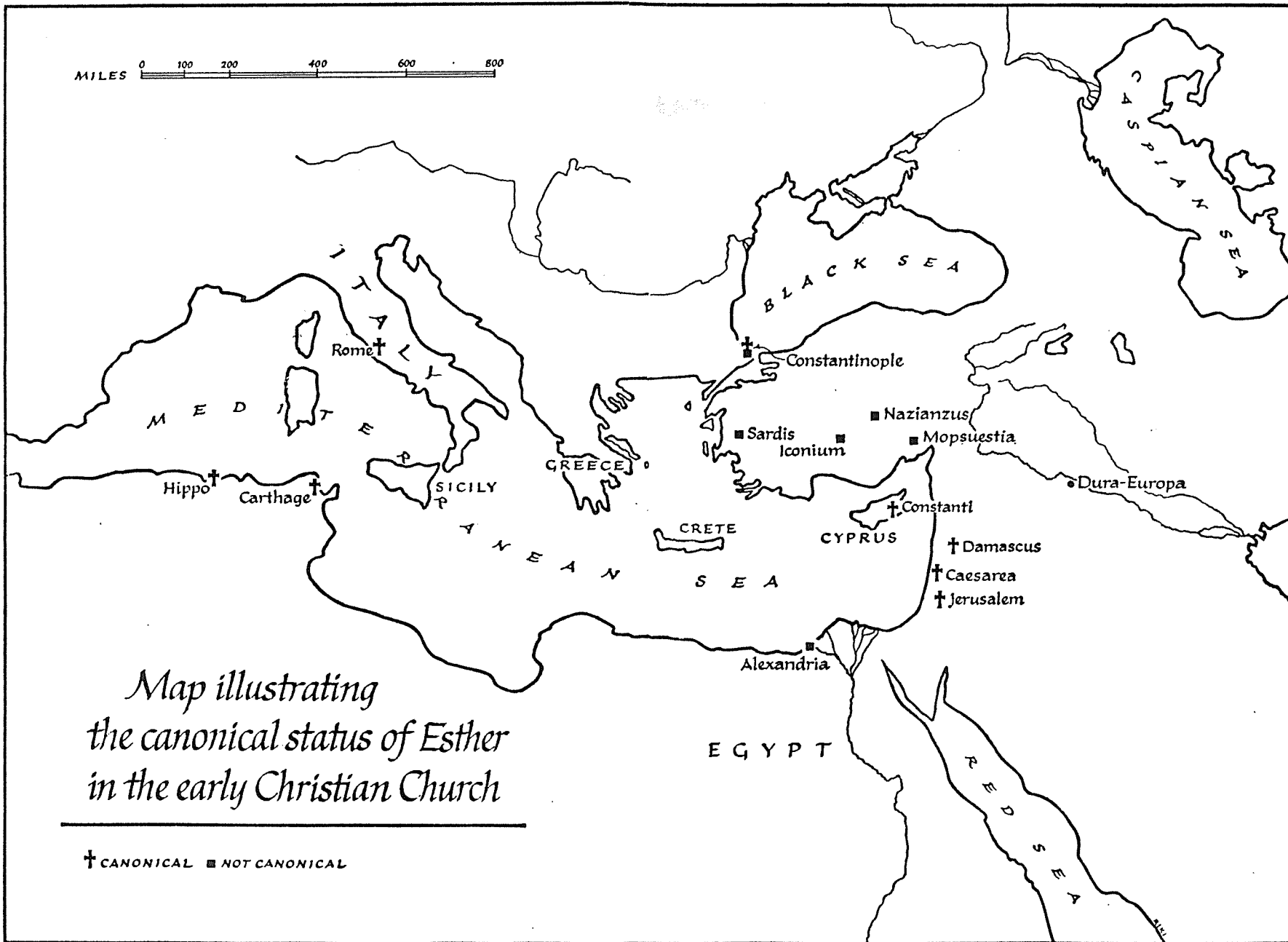

# THE PERSIAN EMPIRE

Map of the Persian Empire  
Barry J. Beitzel, *Moody Atlas of Bible Lands*, 150-51

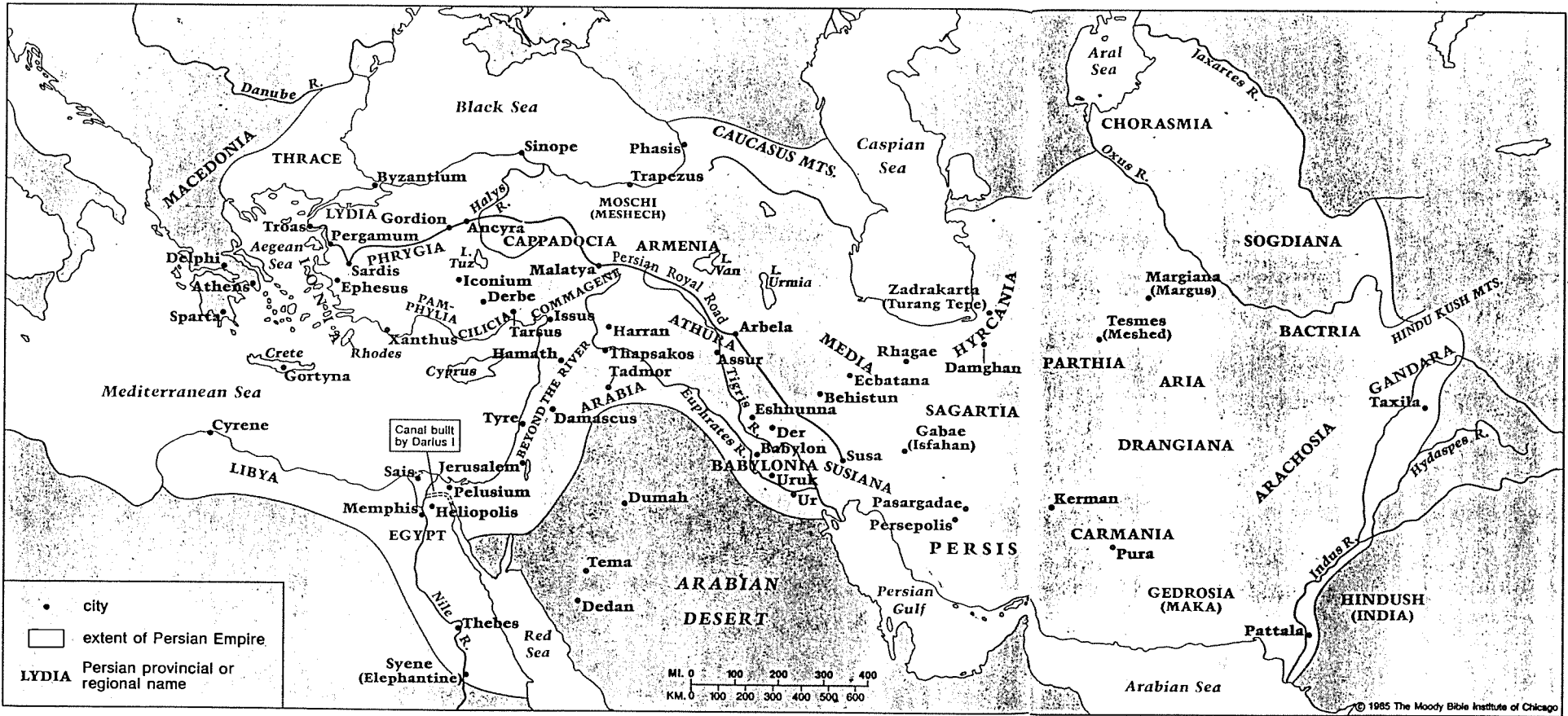

© 1985 The Moody Bible Institute of Chicago

## Shadow and Fulfillment in the Book of Esther

The Conclusion to an Article of the Same Title by Michael J. Wechsler, *Bibliotheca Sacra* 154 (July-September 1997): 275-84

284 BIBLIOTHECA SACRA / July-September 1997

In summary, the various points of "shadow" (*σκιά*) and "substance" (*σῶμα*) may be listed here as follows:

1. *Shadow*: Esther's three-day period of fasting began during the daylight hours of Nisan 14, the first day of Passover. *Substance*: Jesus' three-day period of death began sometime around three o'clock during the daylight hours of Nisan 14, the first day of Passover.

2. *Shadow*: Fasting in general, and thus the fast undertaken by Esther, is identified in Scripture with "humiliation" or "affliction," and inasmuch as her mourning (and a change into mourning garments) was involved, the fast may also represent her temporary "state of death." *Substance*: Jesus' three-day period of physical death (initiated by the cross, Phil. 2:8) is identified in Scripture as the period of His "humiliation" or "affliction" (*ταπείνωσις*).

3. *Shadow*: Esther's period of ταπείνωσις ended on the third day, Nisan 16 (Esth. 5:1). *Substance*: Jesus' period of ταπείνωσις ended on the third day, Nisan 16 (Acts 10:40; 1 Cor. 15:4).

4. *Shadow*: On concluding her fast (i.e., after arising from her symbolic state of death) but before her self-presentation to the king, Esther was clothed in royalty (Esth. 5:1). *Substance*: At the end of his three-day period of death, but before His self-presentation to God the Father in heaven, Jesus was resurrected "in glory" (ἐν δόξῃ, 1 Cor. 15:20, 43).

5. *Shadow*: Esther presented herself, on the basis of her fast (Esth. 4:16), before the king, who then accepted her into his presence (5:2). *Substance*: Jesus, on the basis of His atoning sacrifice and death (Heb. 2:9-10, 14), entered into the Father's presence in the true holy of holies in heaven (9:12, 24), and was accepted into His presence to sit at "the right hand of God" (10:12; 12:2).

6. *Shadow*: The result of Esther's acceptance by the king was the salvation of her people, of which salvation Gentiles also took part (Esth. 8:17) through initiation (by physical circumcision) into the community of faith. *Substance*: The result of Jesus' acceptance by the Father is the salvation of His people (i.e., "the lost sheep of the house of Israel," Matt. 15:24), that is, Jews who are circumcised not only physically but also spiritually through faith in Him (Rom. 2:28-29). Gentiles may also take part in this salvation through initiation (by spiritual circumcision, Col. 2:11) into the (remnant) community of faith (Acts 11:18; Gal. 3:8).

# Old Testament Keyword Song

Swing style

Lyrics & Music:  
Sharon Wang

Musical notation for the first system (measures 1-4). The key signature is three sharps (F#, C#, G#) and the time signature is 4/4. The melody is in the treble clef, and the accompaniment is in the bass clef.

Musical notation for the second system (measures 5-8). The key signature is three sharps (F#, C#, G#) and the time signature is 4/4. The melody is in the treble clef, and the accompaniment is in the bass clef.

Musical notation for the third system (measures 9-12). The key signature is three sharps (F#, C#, G#) and the time signature is 4/4. The melody is in the treble clef, and the accompaniment is in the bass clef.

Musical notation for the fourth system (measures 13-16). The key signature is three sharps (F#, C#, G#) and the time signature is 4/4. The melody is in the treble clef, and the accompaniment is in the bass clef. Chord symbols are placed above the staff: E, B, G#7, and C#m. Lyrics are written below the staff.

Gen - e - sis    E - lec - tion,    Ex - o - dus    For - ma - tion    Lev -

Musical notation for the fifth system (measures 17-20). The key signature is three sharps (F#, C#, G#) and the time signature is 4/4. The melody is in the treble clef, and the accompaniment is in the bass clef. Chord symbols are placed above the staff: A, B, E, and E. Lyrics are written below the staff.

i - ti - cus    Sanc - ti - fi - ca - tion

Old Testament Keyword Song (2 of 7)

21                    A                    B                    G#7                    C#m

Num - bers Pre - pa - ra - tion Deut - e - ro - no - my Re - ne - wal

25                    A                    B                    C#m >

Jos - hua Oc - cu - pa - tion Jud - ges Fail - ure Ruth Re -

29                    A                    B                    E                    C#m

ward Sam - uel Sam - uel Tran - si - tion & Co - ve - nant Kings Kings

33                    A                    B                    E

Di - vi - sion & Down - falls all - in - one Chron - i

Old Testament Keyword Song (3 of 7)

37 A B E C#m  
cles One & Two E - stab - lish - ment & Pre - ser - va - tion

41 A B E  
Ez - ra Tem - ple Ne - he - mi - ah Walls

45 F C Dm Am  
Es - ther Prov - i - dence Job In - com - pre - hen - si - bi - li - ty

49 Bb F/A Gm7 F/A  
Psalms Praise Pro - verbs Wis - dom Ec - cle - si - as - tes Mean - ing - less - ness



Old Testament Keyword Song (4 of 7)

53  $B^b$   $E^b$  C F  
Song - of - Songs is Love I - sa - iah

57 C Dm Am  $B^b$   
Res - to - ra - tion Jer - e - mi - ah In - e - vi - ta - ble La - men - ta - tions

61 F/A Gm7 C  
Con - fes - sion E - ze - ki - al Glo - ry

65  $B^b$  C Am Dm  
Dan - iel Sove - reign - ty Ho - se - a Lo - yal - ty

Old Testament Keyword Song (5 of 7)

69 B<sup>b</sup> C F

Lo - cust Jo - el A - mos In - jus - tice

73 B<sup>b</sup> C Am<sup>7</sup> Dm<sup>7</sup>

E - dom O - ba - di - ah Jo - nah Com - pas - sion

77 B<sup>b</sup> C F

Mi - cah Ex - ploi - ta - tion.

81 C Dm<sup>7</sup> Am<sup>7</sup>

Na - hum Nin - e - vah Ha - bak - kuk is faith

### Old Testament Keyword Song (6 of 7)

85  $B\flat$  F/A  $Gm^7$  C  
Zeph - a - ni - ah Day Hag - gai Prior - i - ties

89 F C  $Dm^7$   $Am^7$   
Zech - a - ri - ah Mes - si - ah Mal - a - chi Hy - po - crites

93  $B\flat$   $Am$  A  $Dm^7$   $B\flat$  C F  
That's the Old - Tes - ta - ment with key - words with each book.

97 F C  $Dm$   $Am$   
I can tell the key words too, With each book of God's ho - ly Word

The musical score is written for voice and piano. It consists of four systems of music. Each system includes a vocal line with lyrics and a piano accompaniment with treble and bass staves. Chord symbols are placed above the vocal line. The key signature is one flat (B-flat major or F minor). The time signature is 4/4. The lyrics are: 'Zeph - a - ni - ah Day Hag - gai Prior - i - ties', 'Zech - a - ri - ah Mes - si - ah Mal - a - chi Hy - po - crites', 'That's the Old - Tes - ta - ment with key - words with each book.', and 'I can tell the key words too, With each book of God's ho - ly Word'.

Old Testament Keyword Song (7 of 7)

101 B $\flat$  Am A Dm $^7$  B $\flat$  C F

It is ea - sy as A - B - C And they are in my heart.

105 F C/E Dm Am B $\flat$  Am A Dm Gm B $\flat$  C

La la la la la la la la la la la la - la - la - la la la - la - la - la

109 F C/E Dm Am B $\flat$  Am A Dm Gm

la la la la la la la la la la la - la - la - la - la - la la la

113 C $^7$  F

la la la

## Midterm Exam Study Questions

*A Guide to Preparing for the OT Survey Take-Home Midterm Exam*

### Format

This exam is a seven page comprehensive test composed of various types of questions: multiple-choice, map identifications, charts, essays, and diagrams. You will have two hours to complete it on your own time before the next class session. You can use an English dictionary but you will not be allowed to use your class notes or books or Bible. The Lord will be your judge.

### Content

Please give attention to the following issues to prepare for the exam:

1. The exam will cover only the pre-exilic books in volume 1 of the class notes. It will *not* cover readings from Arnold/Beyer and Beitzel as these have already been tested on the quizzes (though overlapping material from readings and notes will be addressed if it is in the notes).
2. Make sure you grasp the overall big picture of the OT periods. These pages can help:
  - 20 Stages of God's Plan in History
  - 35 Structure of the OT
  - 43 Integration of the OT
  - 232 Chart of the OT Kings and Prophets (major dates and structure)

*Generally* contrast books and historical stages (pp. 97a, 134a, 180, 184a, 187, 221, 267a)
3. Be familiar with the basic biblical theology (kingdom view, pp. 32-33, 39-40) and tenants/timing of the major covenants (Abrahamic, Mosaic, Land, Davidic, New):
  - 21 The Abrahamic Covenant & Its Fulfillment
  - 22 Kingdom & Covenants Timeline
  - 59-61 Nature & Relationship of the Abrahamic to Other Covenants
  - 116 Contrasting the Abrahamic & Mosaic Covenants
  - 193 Theology of Judges, Ruth & Samuel
4. Know the following for each of the 14 pre-exilic OT books:
  - Period in which it was written (p. 43).
  - Key word (pp. 39) and meaning of this word
  - Title phrase at the top of each book chart (e.g., "Origin in Election & Promise," p. 56)
  - Summary statement (pp. 41-42)
  - Content in basic form
  - Characteristics that make this particular book unique
5. Know the key geographical locations of pagan peoples such as those of Ammon, Phoenicia, Philistia, etc. on "The Old Testament World" map (pp. 27) and the tribes on the "Division of Canaan" map (p. 171).
6. Know which OT book has these significant people: Levites vs. priests, Rehoboam, Gideon, Solomon, Elisha, David, Samson, Elijah, Saul, Isaac, Jeroboam, Nathan, Jacob, Caleb, Ahab, etc.
7. Be able to recognize the book from which an important verse was taken.
8. Review any quizzes on key background issues (if I gave you any quizzes!). Also, know the class notes on the dates of creation (pp. 58, 85) and the Exodus (p. 99), as well as about salvation in the OT (pp. 119e, 122), judges vs. kings (pp. 184a, 200), and the dynasties of Israel and Judah (p. 236-37, 265).
9. Make more copies of the blank chart on page 233 and fill them out for study.
10. Most of all, pray for God to help you retain what you have gained from this course throughout your life—especially in ministry situations when an overview of the OT will help others know Him in a deeper way.